



Extreme X8S
Actioncam

NIKKEI

- EN For more information see www.nikkei.eu
- NL Voor meer informatie zie www.nikkei.eu
- D Für weitere Informationen siehe www.nikkei.eu
- F Pour plus d'informations, veuillez consulter le site www.nikkei.eu
- E Para más información, visite www.nikkei.eu
- DA For mere information besøg www.nikkei.eu
- FI Lisätietoja löydät osoitteesta www.nikkei.eu



1 Check the contents

Controleer de inhoud
Kontrollieren Sie den Inhalt
Vérifiez le contenu
Revise el contenido
Kontroller indholdet
Tarkista sisältö

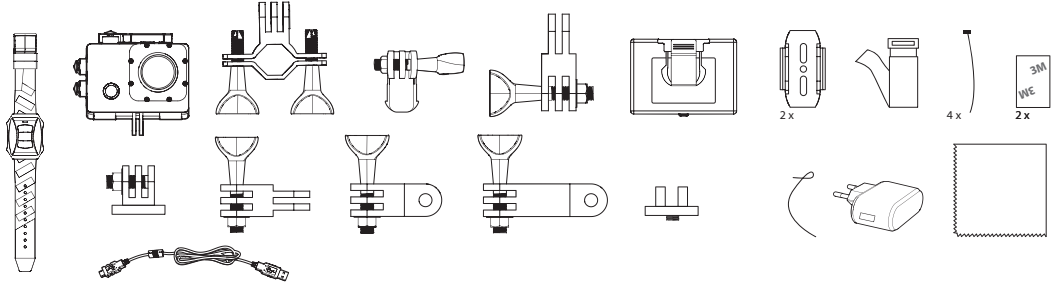

2 Charge the appliance

Het apparaat laden
Gerät laden
Charger l'appareil
Cargar el dispositivo
Lad apparatet op
Lataa laite

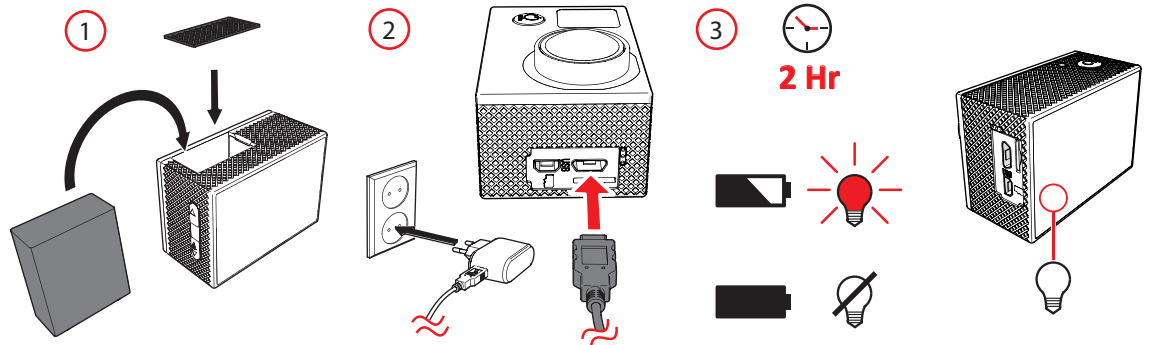

3 Slot-in for micro SD card

Micro SD-kaart ingang
Anschluss für Micro-SD-Karte
Connecteur pour carte micro mémoire flash
Entrada para tarjeta micro SD
Slids til micro SD
Micro SD-korttipaikka

Max. 64 GB

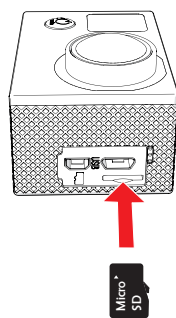

4 Functions

Functies
Funktionen
Fonctions
Funciones
Funktioner
Toiminnot

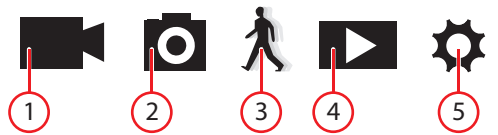

1	Film	4	Play
2	Photo	5	Settings
3	Slow filming		

5 Main parts

Belangrijkste onderdelen
Hauptkomponenten
Pièces principales
Partes principales
Hoveddele
Pääosat

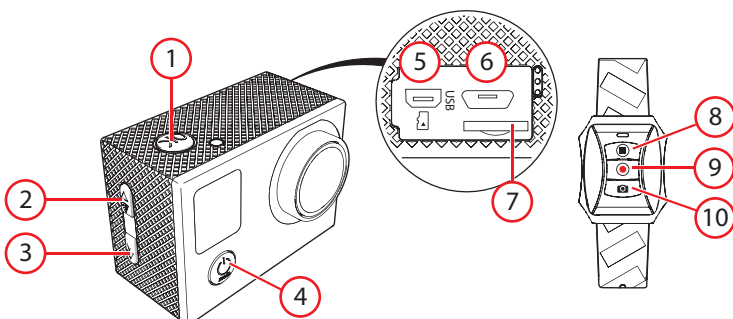

1	OK	6	USB port 2.0
2	◀ UP	7	MICRO SD CARD
3	▶ DOWN	8	STOP RECORD
4	ON / OFF / MODE	9	START RECORD
5	HDMI	10	PICTURE / SLEEP MODE

6 Turn the appliance on/off

Het apparaat aan en uit zetten
Das Gerät an- und ausschalten
Mettre l'appareil en service/hors service
Encender/apague el aparato
Tænd/sluk apparatet
Kytke laite päälle/pois päältä

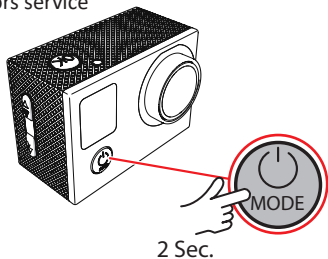

7 Start filming

Beginnen met filmen
Videoaufnahme starten
Démarrer la vidéo
Comenzar a grabar
Start med at filme
Aloita kuvaus

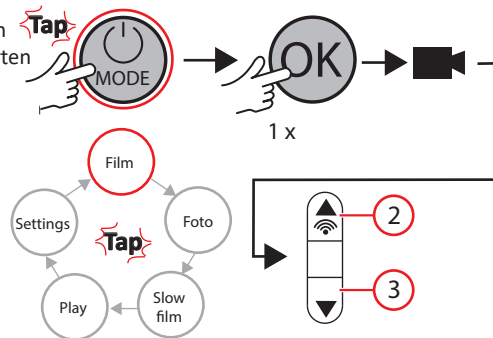

8 Make a photo

Een foto maken
Ein Foto machen
Prendre une photo
Tomar una fotografía
Tag et foto
Ota kuva

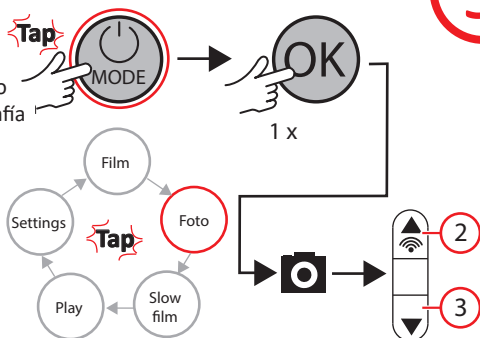

9 Start slow filming

Beginnen met langzaam filmen
Zeitlupe-Videoaufnahme starten
Démarrer une vidéo lente
Iniciar grabación lenta
Start med at filme langsom
Aloita hidastettu kuvaus

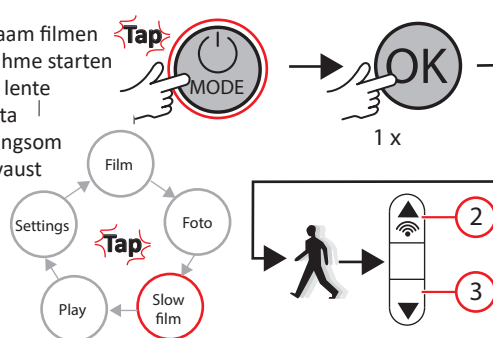

10 Play

Afspelen
Wiedergabe
Lecture
Reproducir
Afspil
Toista

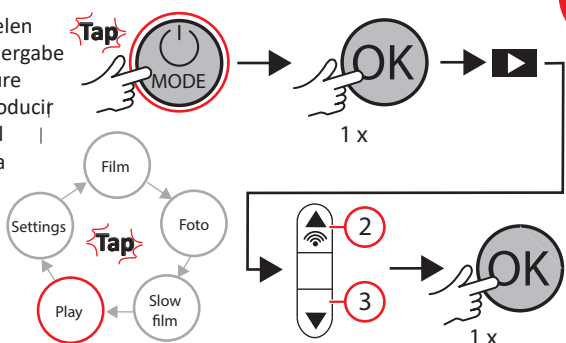

11 Settings

Instellingen
Einstellungen
Paramètres
Ajustes
Indstillinger
Asetukset

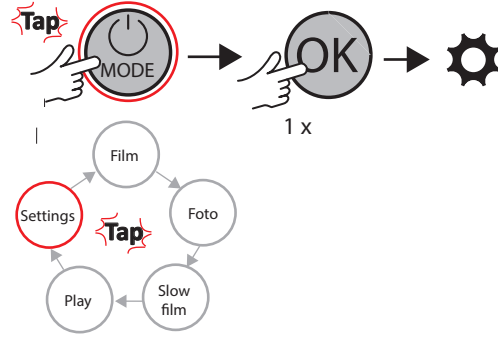

12 Make a WIFI connection

Een WIFI verbinding maken
Eine WLAN-Verbindung herstellen
Faire une connexion WIFI
Realizar una conexión WIFI
Opret en WIFI-forbindelse
Muodosta Wi-Fi-yhteys



Install App: Be ExtremeX

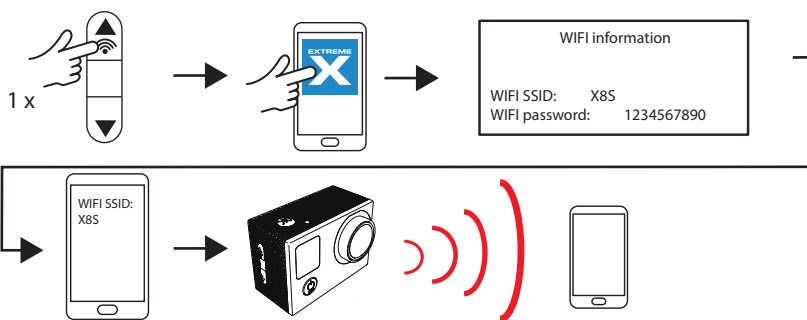

Specifications

Specificaties

Technische Daten

Spécifications

Especificaciones

Specifikationer

Tekniset tiedot

Model number: Extreme X8S
DSP: V3

Model number: Extreme X8S
DSP: V3

Modellnummer: Extreme X8S
DSP: V3

Numéro de modèle: Extreme X8S
DSP: V3

Número de modelo: Extreme X8S
DSP: V3

Modelnummer: Extreme X8S
DSP: V3

Mallinnumero: Extreme X8S
DSP: V3

Image Format: JPEG
Video Format: MP4

Formaat foto: JPEG
Formaat video: MP4

Bildformat: JPEG
Videoformat: MP4

Format d'image: JPEG
Format vidéo: MP4

Formato de imagen: JPEG
Formato de vídeo: MP4

Billedformat: JPEG
Videoformat: MP4

Kuvamuoto: JPEG
Videomuoto: MP4

Charging Time: +- 2 hours
Size: 59 x 41 x 29mm
Weight: 44gr (without batteries), 58gr with batteries

Laadtijd: +- 2 hours
Afmetingen: 59 x 41 x 29mm
Gewicht: 44gr (zonder batterijen), 58gr met batterijen

Ladezeit: +- 2 Stunden
Abmessungen: 59 x 41 x 29 mm
Gewicht: 44 g (ohne Akku), 58 g mit Akku

Durée de recharge :
+- 2 heures
Dimensions : 59 x 41 x 29 mm
Poids : 44 g (sans batteries), 58 g avec batteries

Tiempo de carga: +- 2 horas
Tamaño: 59 x 41 x 29 mm
Peso: 44 g (sin pilas), 58 g con pilas

Ladetid: +- 2 timer
Størrelse: 59 x 41 x 29mm
Vægt: 44 gr (uden batterier), 58 gr med batterier

Latausaika: +- 2 tuntia
Koko: 59 x 41 x 29 mm
Paino: 44 g (ilman akkuja), 58 g akkujen kanssa

Waterproof in case

Waterbestendig in de behuizing

Wasserdicht im Gehäuse

Étanche dans le logement

Sumergible en el viviendas

Vandtæt i boliger

Vedenpitävä ett kotelo