

KODAK PIXPRO ORBIT360 4K/4KVR360

VR CAMERA

User Manual



Before You Start

Declaration of Conformity

Responsible Party: JK Imaging Ltd.



Address: JK Imaging Ltd., 17239 So. Main Street, Gardena, CA 90248 USA

JK Imaging Europe, 71 Clarendon Road, Watford, WD17 1DS, UK

Company Website: kodakpixpro.com

About this Manual

Thank you for purchasing this KODAK PIXPRO 360° VR Camera. Please read this manual carefully and keep it in a safe place for future reference.

- JK Imaging reserves all rights of this document. No part of this published manual may be reproduced, transmitted, transcribed, stored in a retrieval system or translated into any language or computer language, in any form, by any means, without the prior written permission of JK Imaging.
- All trademarks mentioned in this manual are used for identification purposes only and are properties of their respective owners.
- This manual provides you with instructions on how to use your new KODAK PIXPRO 360° VR CAMERA. Every effort has been made to ensure that the contents of this manual are accurate; however JK Imaging reserves the right to make changes without notice.
- Throughout this manual, " " indicates useful information, " page number" indicates an introduction to contents on the specified page.

For Customers in the U.S.A.

Federal Communication Commission Interference Statement

This device complies with Part 15 of the FCC Rules. Operation is subject to the following two conditions: (1) This device may not cause harmful interference and (2) this device must accept any interference received, including interference that may cause undesired operation.

This equipment has been tested and has been found to comply with the limits for a Class B digital device, pursuant to Part 15 of the FCC Rules. These limits are designed to provide reasonable protection against harmful interference in a residential installation. This equipment generates, uses and can radiate radio frequency energy and if not installed and used in accordance with the instructions, may cause harmful interference to radio communications. There is no guarantee that interference will not occur in a particular installation. If this equipment does cause harmful interference to radio or television reception, which can be determined by turning the equipment off and on, the user is encouraged to try to correct the interference by one of the following measures:

- Reorient or relocate the receiving antenna
- Increase the area of separation between the equipment and receiver
- Connect the equipment into an outlet on a different circuit from that to which the receiver is connected
- Consult an experienced radio/TV technician for advice or help

FCC Caution: Any changes or modifications not expressly approved by the party responsible for compliance could void the user's authority to operate this equipment.

This transmitter should not be co-located or operated in conjunction with any other antenna or transmitter.

Radiation Exposure Statement:

This product complies with the FCC portable RF exposure limit set forth for an uncontrolled environment and is safe for the intended operation as described in this manual. Further reduction of RF exposure can be achieved if the product is kept as far away as possible from the user's body or by setting the device to lower power output if such functionality is available.

Canadian Industry Statement:

This device complies with ISED's licence-exempt RSS's. Operation is subject to the following two conditions: (1) This device may not cause harmful interference and (2) this device must accept any interference received, including interference that may cause undesired operation.

Radiation Exposure Statement:

This product complies with the Canadian portable RF exposure limit set forth for an uncontrolled environment and is safe for intended operation as described in this manual. Further reduction of RF exposure of can be achieved if the product is kept as far away as possible from the user's body or by setting the device to lower power output if such functionality is available.

For Customers in Europe



This symbol [crossed-out wheel bin WEEE Annex IV] indicates the separate collection of electrical waste and electronic equipment in European countries. Please do not throw the equipment into domestic refuse. Please use the return and collection systems available in your country for proper and safe disposal of this product.

CE The “CE” mark indicates that this product complies with European requirements for safety, health, environment and customer protection. “CE” marked cameras are intended for sales in Europe.

Europe – EU Declaration of Conformity

This device complies with the essential requirements of the RED Directive 2014/53/EU. The following test methods have been applied in order to prove presumption of conformity with the essential requirements of the RED Directive 2014/53/EU:

- EN60950-1/A12:2011+A2:2013
Safety of Information Technology Equipment
- EN 62311:2008
Assessment of electronic and electrical equipment related to human exposure restrictions for electromagnetic fields (0 Hz-300 GHz)
- EN 300 330-1 V2.1.1:2017
Electromagnetic compatibility and Radio Spectrum Matters (ERM); Short Range Devices (SRD); Radio equipment in the frequency range of 9 KHz to 25 MHz and inductive loop systems in the frequency range 9 KHz to 30 MHz
- EN 300 328 V2.1.1 (2016-11)
Wideband transmission systems; Data transmission equipment operating in the 2.4 GHz ISM band and using wide band modulation techniques
- EN 301 489-1 V1.9.2:2011
Electromagnetic compatibility and Radio Spectrum Matters (ERM); ElectroMagnetic Compatibility (EMC) standard for radio equipment and services; Part 1: Common technical requirements
- EN 301 489-3 V1.6.1:2013
Electromagnetic compatibility and Radio Spectrum Matters (ERM); ElectroMagnetic Compatibility (EMC) standard for radio equipment and services; Part 3: Specific conditions for Short-Range Devices (SRD) operating on frequencies between 9 KHz and 246 GHz
- EN 301 489-17 V2.2.1:2012
Electromagnetic compatibility and Radio Spectrum Matters (ERM); ElectroMagnetic Compatibility (EMC) standard for radio equipment; Part 17: Specific conditions for Broadband Data Transmission Systems

Sintai Optical (Shenzhen) Co., Ltd., declares that this [KODAK PIXPRO 4KVR360 and BLUETOOTH Remote] is in compliance with the essential requirements and other relevant provisions of Directive 1999/5/EC.

Manufacturer: Sintai Optical (Shenzhen) Co., Ltd.

Address: Qiwei Ind Sec, 1st, 2nd, & 3rd Bldg, Lisonglang Village, Gongming Town, Bao'an District, Shenzhen, Guangdong, China



Packaging: Please follow local regulations for recycling of product packaging.

Batteries: Please dispose of used batteries at designated collection and recycling centers.

SAR Statement

A minimum separation distance of zero cm must be maintained between the user's body and the device, including the antenna during body-worn operation to comply with the RF exposure requirements in Europe.

To comply with the RF Exposure requirements or limitations in Europe, third-party belt-clips, holsters or similar accessories used with this device should not contain any metallic components. The use of accessories that do not satisfy these requirements may not comply with RF exposure requirements or limitations and should be avoided.

Safety Notes

Product Notes:

- Do not disassemble or attempt to repair this product by yourself.
- Do not handle this product improperly. This product may be damaged or permanently broken if dropped, punctured or crushed.
- Avoid directly touching the lens elements. Please use a professional soft lens cleaning cloth together with a gentle lens cleaning agent to wipe and clean the camera lenses for optimal performance.
- Do not use corrosive, alcoholic or organic solvent containing agents to clean this product.
- Do not use or store this product in high temperature environments.
- Do not expose the lenses to strong light sources (e.g. direct sunlight, etc.) for extended periods of time.
- Do not use or store the product in a strong magnetic field environment.
- If the product is quickly transferred from a low temperature to a higher temperature environment, water condensation may occur inside the product due to physical changes. In this case, it is recommended to wait until the product returns to normal room temperature before you turn it on again to operate.
- If a photo or video cannot be played back due to improper operation by the user, the Company shall assume no liability or responsibility for compensation.
- Keep the product in a dry and clean environment when you are going to store the product for long periods of time.
- Due to the characteristics of the electronic elements inside the camera, the temperature of the camera will increase (heat will be emitted) in the process of use. Even though the temperature could be relatively high and heat is emitted from the surface of the camera, the camera is capable of shooting continuously and operating properly. When the camera detects that the temperature of the camera body is within certain limitations it will power off automatically.
- In case of powering off due to increased temperature limitations, the camera can be powered on again for use after its temperature cools and returns to normal.

Battery Notes:

- Please use the included Li-ion battery or replacement battery that is the same type as the one included.
- If the battery overheats during charging or using, stop charging or using immediately. Turn the camera off, carefully remove the battery and wait until it cools down completely.
- Please keep the battery contacts clean and dry.
- Install the battery according to the positive and negative marks on the camera's battery compartment. Never force it into the battery compartment.
- If battery fluid leaks into the product, please contact our customer service center immediately. If battery fluid leaks onto your skin, rinse the area immediately with clean water and seek immediate medical attention.
- To prevent the battery from being damaged, do not drop the battery, hit it with heavy objects or scratch it with sharp objects.
- Do not let the battery come in contact with metal objects (including coins) in order to avoid short-circuiting, discharging, excessive heating or possible leakage.
- Do not heat the battery or throw it into a fire to avoid serious injury or a possible explosion.
- Remove the battery if the camera will be stored for a long period of time.
- Do not store the battery in high temperature environments.
- Using the battery in cold environments will result in much lower camera performance.
- Do not attempt to disassemble the battery by yourself.
- Please dispose of the battery properly and according to your local laws and regulations (national or regional).

Memory Card Notes:

- The memory card referred to in this user manual is a microSD card, microSDHC card or microSDXC card, class 10 or higher.
- Please keep the memory card clean and dry.
- When inserting a memory card, make sure the notch direction of the card matches the notch direction of the memory card mark near the camera's card slot. Never force the memory card into the card slot.
- Before using any brand new memory card, please format the memory card first.
- A photo or video taken with the product will be stored in a folder that is automatically generated on the memory card. Do not store photos or videos that were not taken using the product in these folders, in case the files cannot be recognized during normal playback.
- Directly editing the data on the memory card is not recommended. Always copy the data to your computer first before editing.
- Turn the product off before removing the memory card, otherwise the memory card or files could be damaged permanently and files/folders could be permanently lost.
- When the camera is stored for a long period of time, please backup the data on the memory card and remove the memory card from the camera.







Other Notes:











- Do not disconnect the power or turn the product off during the firmware updating process. Doing so may cause incorrect data to be written and the product may not power on later.
- When using your product on an airplane, observe the relevant rules specified by the airline and Federal regulations.
- Due to the limitations of manufacturing technology, the camera's LCD may have a few dead or bright pixels. This is completely normal and these pixels do not affect the quality of the photos or videos taken with this camera.
- If the LCD screen is damaged, please pay close attention to the liquid crystal phosphor inside the screen. If any of the following situations arise, kindly take the recommended actions immediately as indicated below:
 1. If liquid crystal comes in contact with your skin, please wipe your skin with a clean, dry cloth, thoroughly wash with soap and rinse with plenty of clean water.
 2. If liquid crystal gets into your eye, flush your eye immediately with plenty of clean water for at least 15 minutes. Please seek immediate medical assistance.
 3. If liquid crystal is accidentally swallowed, rinse your mouth immediately with clean water and try to induce vomiting. Please seek immediate medical assistance.

Waterproof Notes:

- This product is splash proof for the purpose of daily activities. Before use, please make sure to fully lock the battery cover to ensure a complete seal.
- Any scratches, cracks or small foreign objects (such as sand or hair) attached to the rubber ring inside of the battery cover will affect the efficiency of the splash proof function. Before use, please check whether the waterproof rubber ring is damaged or contaminated with a foreign object before closing the battery cover door. When there is a foreign object on the waterproof rubber ring and its adjacent surfaces, please use a clean, lint-free, dry cloth to clean it. If there are any scratches or cracks, contact our service center immediately for maintenance and/or obtain a replacement waterproof rubber ring.
- Do not directly open the battery cover door when the product is accidentally exposed to water. Please turn off the camera's power and thoroughly wipe it with a clean, dry, lint-free cloth before opening the battery cover door in order to remove the battery and the memory card.
- When opening the battery cover door, if there are water droplets on the surfaces located between the interior of the camera and the camera body, please make sure to fully wipe and dry them off.
- After using the product in the presence of sand, mud or other foreign matter, please carefully rinse it with clean water (fully close the battery cover door tightly before rinsing). After rinsing, wipe the camera with a clean, dry, lint-free cloth.

Contents

Before You Start.....	1
Safety Notes	5
Contents	7
Getting Ready	9
Camera Part Names	10
Mounting / Removing Lens Covers.....	11
Installing the Battery.....	12
Installing a Memory Card	13
Mounting / Removing Battery Cover Door	13
Charging the Battery	14
Main Camera Interface.....	16
Power On / Off	17
Start-up for Date and Time.....	17
Camera Mode Introduction	18
■ Movie Mode 	18
■ Snap Shot Photo Mode 	18
■ Time-Lapse Photo Mode 	19
■ Loop Recording Mode 	19
■ Time-Lapse Video Mode 	19
■ High-Speed Movie Mode 	20

■ Burst Mode 	20
Menu Introduction	21
All Shooting Mode Settings ( /  /  /  /  /  / )	22
General Settings 	30
BLUETOOTH Remote Control-D	33
BLUETOOTH Remote Control-C	38
User Interface	42
Micro USB Interface	42
Charging Your Camera	42
Using an External Power Supply	42
Data Transmission	42
Micro HDMI Interface	44
Wi-Fi Mode 	46
Appendices	50
Prompts and Warning Messages	53
Trouble Shooting	55
Special Accessories	56

Getting Ready

Standard Parts and Accessories Included:

Your product packaging should contain the camera you purchased along with the following standard parts and accessories. If anything is missing or appears to be damaged, please contact our customer service center. (The AC Adapter style will vary according to the power requirements from different countries or regions. Pictures below are for reference only):

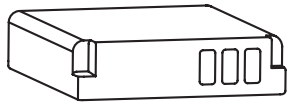

Rechargeable Li-ion Battery

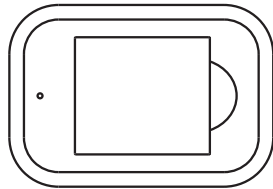

Battery Charger

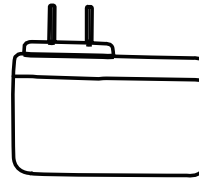

AC Adapter

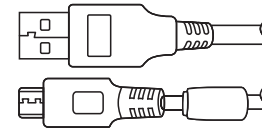

Micro USB Cable

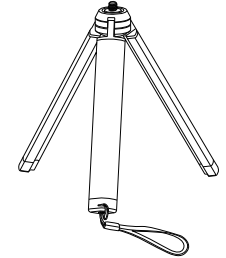

Small 3-Leg Stand-B

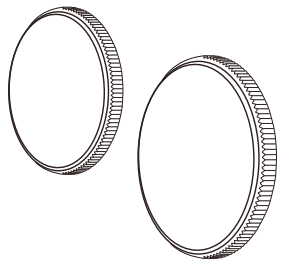

Lens Covers
(B-Small / C-Large)

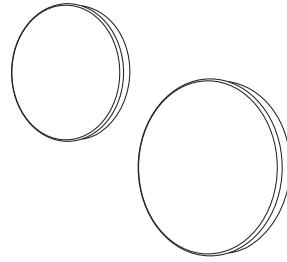

Protective Covers
(B-Small / C-Large)

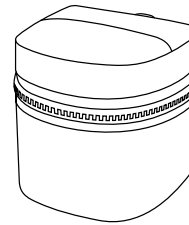

Carrying Case

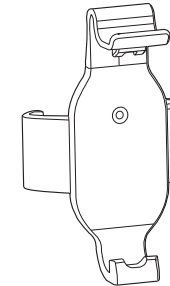

Remote Control
Mount-B

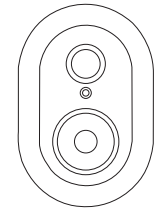

BLUETOOTH Mini
Remote Control-D

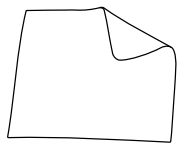

Cleaning Cloth



Quick Start Guide



Warranty Card



Service Card







Online Company
Store Card

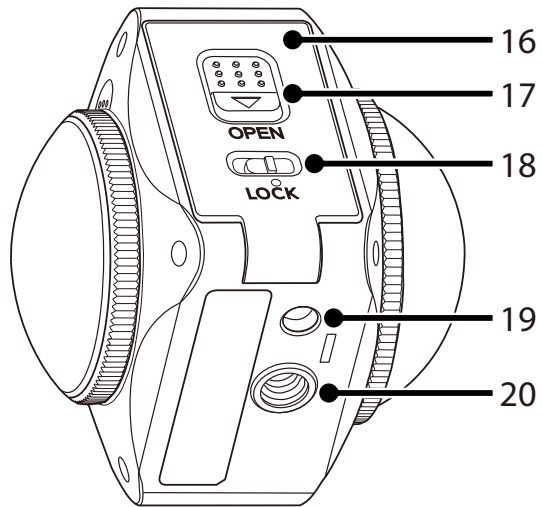
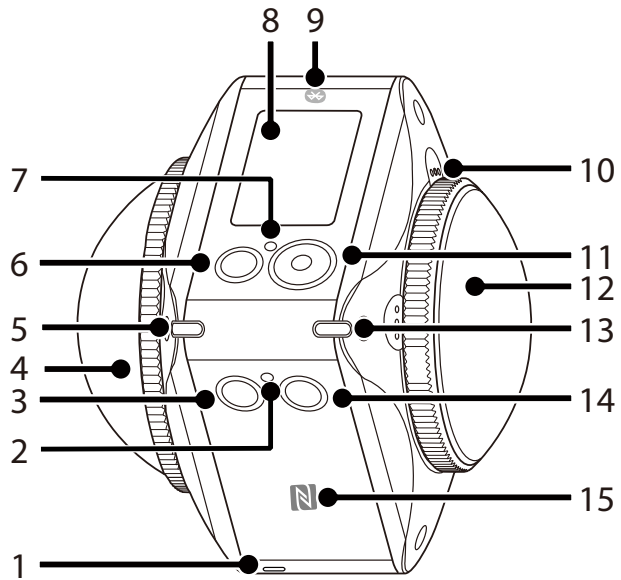

Team 360
Sticker

Camera Part Names



1	Speaker
2	Wi-Fi Indicator
3	 Wi-Fi Button / Direction Button (down) / Remote Control Pairing (press and hold)
4	Lens B (235 Degrees)
5	Lens Status Indicator B
6	 Power Button
7	Status Indicator
8	LCD
9	BLUETOOTH Logo / Mark
10	Exterior Microphone (Stereo)
11	 Video Recording Button / Photo Shooting Button / OK Button
12	Lens A (155 Degrees-VR Mode [2:1]) (197 Degrees-Front Mode [16:9])
13	Lens Status Indicator A
14	 Menu Button / Direction Button (up) / Mode Switching (press and hold)
15	NFC Logo / Mark
16	Battery Cover Door
17	Battery Cover Open Toggle Switch
18	Battery Cover Door Lock
19	Positioning Mount Receptor
20	1/4" Screw Socket

Mounting / Removing Lens Covers:

Removing lens covers:

Turn the clear, protective lens cover counter clockwise following the illustrations below until it separates from the ORBIT360 4K/4KVR360.

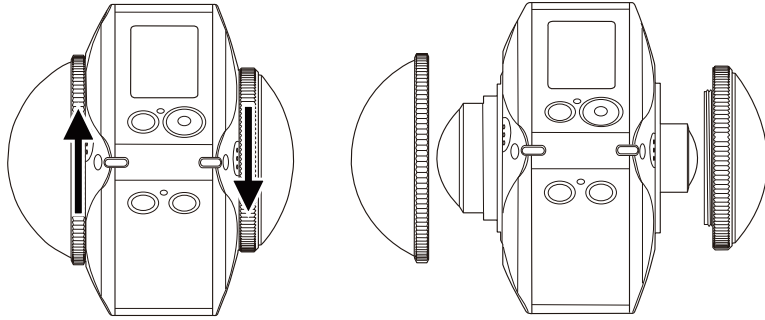

Attaching lens covers:

Turn the lens covers clockwise and firmly tighten the lens covers as illustrated below.

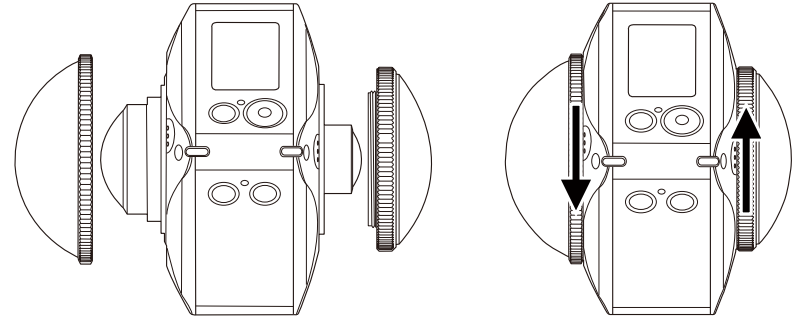

- ④ The lens covers protect the camera's glass lenses from being permanently damaged and are dustproof, shockproof and splash proof. Using the lens covers when taking a photo/shooting a video will not affect the photo image/video quality. Keeping the clear, protective lens covers on the ORBIT360 4K/4KVR360 is essential to being able to use the internal stitch feature of the camera. If you do not use the clear lens covers, you will not be able to stitch photo/videos and render files for sharing.
- ④ Before mounting the clear lens covers, make sure the permanent glass lens surfaces are clean and dry. Always use a clean, lint-free, dry cloth to clean the camera's lenses before shooting or recording so any foreign particles it will not affect the photo or video quality.
- ④ When the ORBIT360 4K/4KVR360 is exposed to extreme temperature differences, condensation may form inside the camera's lens covers. If this happens, remove the lens covers, clean with a soft, dry, lint-free cloth and reinstall the lens covers.
- ④ If the ORBIT360 4K/4KVR360 will not be used for a long period of time or during transportation, always put the black rubber protective covers on (as shown in the image below):



Installing the Battery:

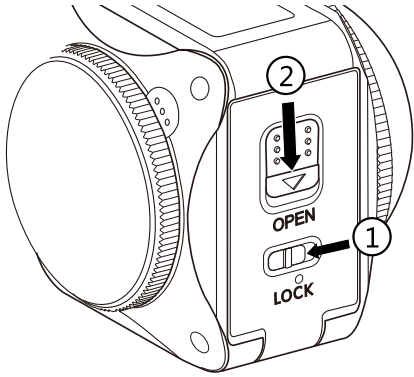

1. Open the Battery Cover Door

Slide the battery cover lock to the left ① , then slide the open switch of the battery cover door downward ② .

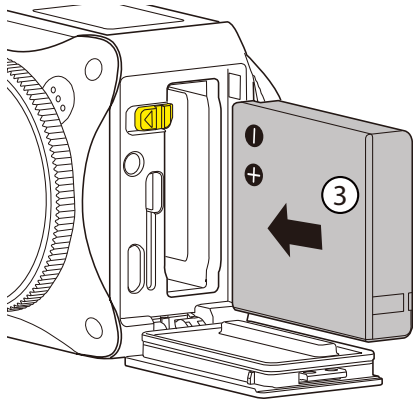

2. Insert the Battery

Insert the Li-ion battery into the battery compartment in the direction of the arrow ③ (note the location of the + and - symbols).

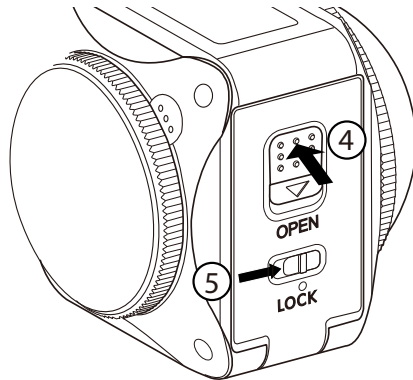

3. Close the Battery Cover Door

Close the battery cover door until you hear a “click” to indicate the door is fully and tightly closed ④ . Slide the battery cover lock to the right ⑤ .

Installing a Memory Card:

Open the battery cover door, then insert the memory card into the card slot as shown in the illustration below (note the direction of the memory card opening). Push the bottom end of the memory card with your fingertip into the slot completely and close the battery cover door.

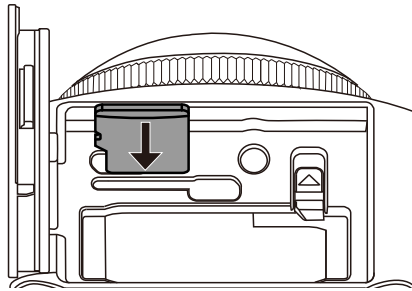

- ④ A memory card (microSD / microSDHC / microSDXC) is essential to recording and saving 360° photos and videos and is not included in the product packaging. The memory card needs to be purchased separately. Please use a memory card which is Class 10 or higher and has a capacity of 8GB to 256GB. When recording with any new memory card Class 10 or higher, it is recommended you format the memory card before using.
- ④ To remove the memory card, open the battery cover door, gently press the memory card to eject it and remove it carefully.
- ④ The camera will automatically turn off if the memory card is inserted or removed when the product is turned on.

Mounting / Removing Battery Cover Door:

Removing Battery Cover Door:

Pull the battery cover door hinge out carefully (as shown in the diagram below) until the battery cover door is separated from the camera body.



Mounting Battery Cover Door:

Snap the battery cover door back on to the camera body at the hinge section as shown in the diagram below.



- ④ With the battery cover removed, user may readily access the USB/HDMI/AV interfaces at their discretion.
- ④ File size may increase or decrease depending on the subject, shooting conditions, etc. Disc capacity varies with manufacturer and formatting method. The exposure time may be used for reference.
- ④ The camera is not waterproof or weatherproof if the battery cover door is removed.

Charging the Battery:

 Please use the supplied battery charger and AC adapter to charge the Li-ion battery in an ambient temperature ranging from 50°F to 95°F or 10°C to 35°C.

Charging the Battery with Included Battery Charger:

1. Place the battery into the battery charger according to the direction illustrated below. Use the Micro USB cable to connect the battery charger to the AC adapter then plug the AC adapter into an electrical outlet.

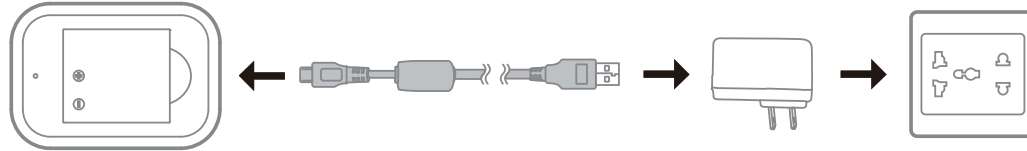

2. The indicator light will turn red when charging. The indicator light will turn green when charging is complete.

 When charging the battery for the first time or after a long period of storage, please make sure that the charging time is a minimum of four hours.

Charging the Camera with an AC Adapter or an External Power Supply (vehicle power supply, portable power supply, etc.):

1. Place the battery into the camera.
2. While in the "off" mode, use the Micro USB cable to connect the camera to the AC adapter first, then plug the AC adapter into an electrical outlet. Alternatively, use the Micro USB cable to connect the camera to an external power supply (vehicle power supply, portable power supply, etc.).

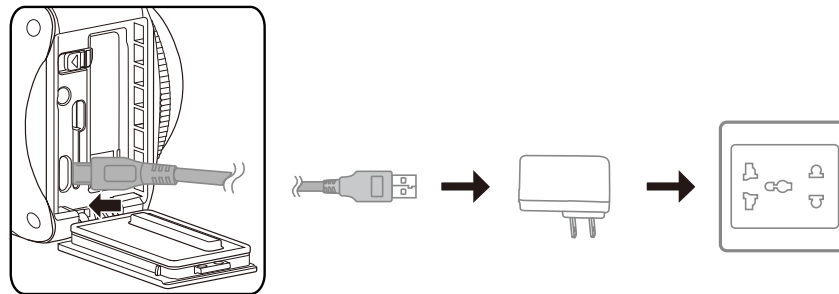

3. The indicator light will turn orange while it is charging. The indicator light will go out once charging is completed and the battery is fully charged.

 The camera cannot be recharged when its power is on.

Charging the Camera via a Computer:

1. Place the battery into the camera.
2. Use the Micro USB cable to connect the camera (in the "off" position) to your computer.
3. The indicator light will remain orange while it is charging. The indicator light will go out once charging is completed and the battery is fully charged.

 The camera cannot be recharged when its power is on.

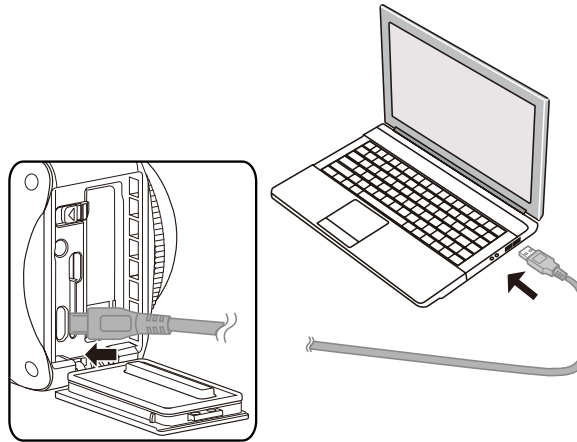

Using the Internal Microphone:

 Please only use a 2.5mm audio cable for the internal microphone. Optional PIXPRO 2.5mm Audio Cables are available for purchase @ kodakpixpro.com (cable sold separately).

Main Camera Interface

■ Main Camera Interface Introduction:

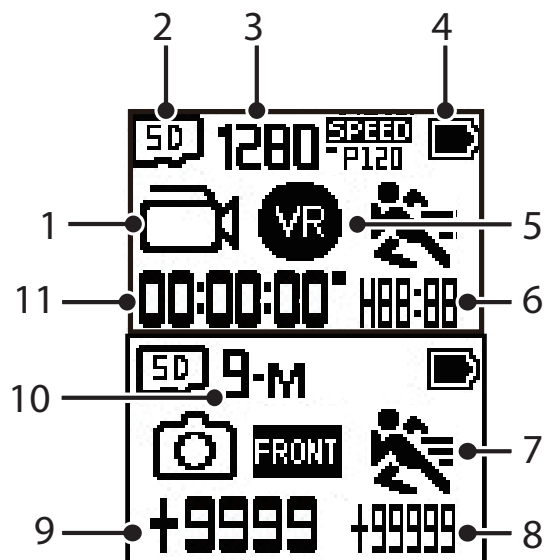

1. Camera Mode

Movie Mode

Snap Shot Photo Mode

Time-Lapse Photo Mode

Loop Recording Mode

Time-Lapse Video Mode

High-Speed Movie Mode

Burst Mode

2. Memory Card

3. Movie Size:

3840[∞]_{P24} / 3840¹⁹²⁰_{P15} / 1920⁹⁶⁰_{P30} / 1280^{SPEED}_{P120}

2880²⁸⁸⁰_{P24} / 1920¹⁹²⁰_{P30}

4K^{P30} / FHD^{Ultra}_{P60} / FHD^{middle}_{P60} / FHD^{narrow}_{P60} / HD^{P60} / HD^{SPEED}_{P120}

4. Battery Status

197° 4K Ultra Wide
4K [16:9] Full Frame

5. Display Mode: 360° Spherical / 235° Round (Dome) Mode /

6. Remaining Recording Time: HH:MM / MM:SS / none

7. Motion Detection (On)

8. Number of Remaining Shots (" +99999 " will be displayed when the SD card exceeds the maximum available display number) / none

9. Existing Document in the Memory Card (" +9999 " will be displayed when the SD card exceeds the maximum available display number)

10. Photo Size: 27M[∞] / 15M[∞] / 27M / 15M

13M

9-M / 8-M

11. Time Recording the Movie

Power On / Off

■ Power On:





When the power is off, press the  button for one second or more to turn the camera on.

■ Power Off:

When the power is on, press the  button for one second or more to turn off the product.





 If the product cannot be powered off normally, you can remove the battery from the camera to force it to power off.







Start-up for Date and Time

1. Press the  button to turn the camera on. When starting for the first time, the display will show the date and time screen setting, "Year/Month/Day/Hour/Minute/Second".
2. The field to be adjusted will be highlighted with a black background color. Press the  (up) or  (down) buttons to adjust the value, press the  button to enter and confirm.
3. After adjusting the "Minute : Second" value, press the  button to enter the main camera menu interface.



Camera Mode Introduction

In the main camera interface, press and hold the  (up) button to enter the mode selection interface. Press the  (up) or  (down) button to select any one mode; press the  button to enter and confirm the mode of the current interface.

7 modes are available: Movie Mode , Snap Shot Photo Mode , Time-Lapse Photo Mode , Loop Recording Mode , Time-Lapse Video Mode , High-Speed Movie Mode , and Burst Mode .

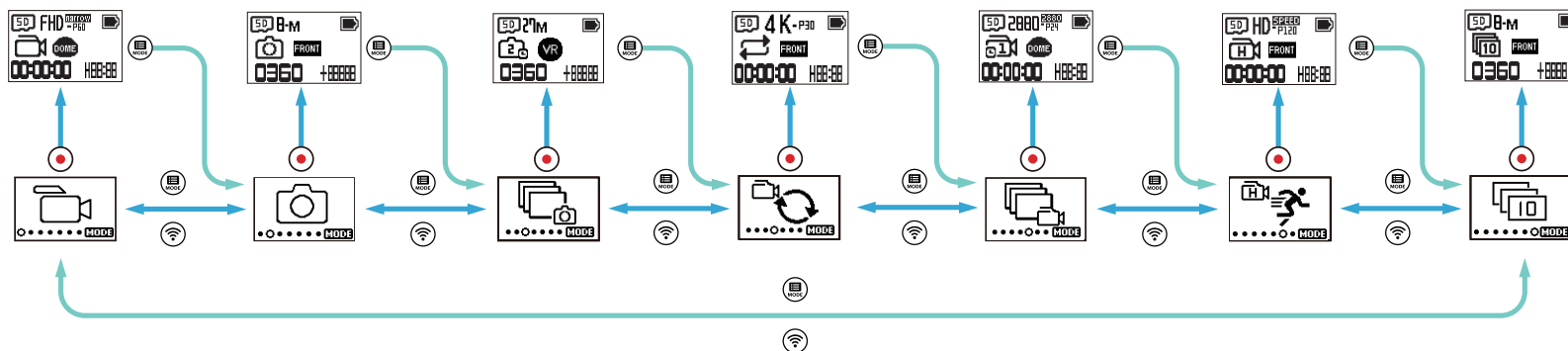

■ Movie Mode

Enable video recording. This mode is suitable for recording in most conditions.

Operation Method:

Press the  button to start recording. Press the  button again to stop recording.

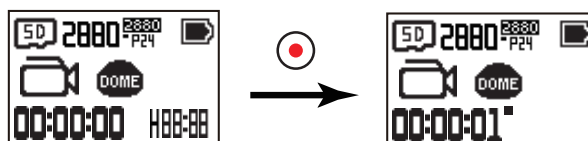

■ Snap Shot Photo Mode

Enable photo shooting. This mode is suitable for shooting photos in most conditions.

Operation method:

Press the  button to take a photo.

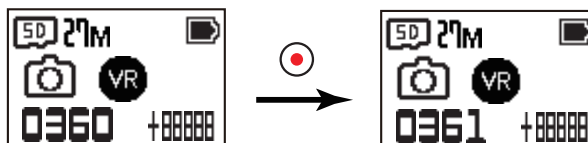

■ Time-Lapse Photo Mode

Time-Lapse Photo means shooting at a certain time interval and saving the shot photos in the same folder. If the number of files exceeds the maximum number of folder (9999), create a new folder.

Operation method:

Press the  button to start shooting photos. Press the  button again to stop shooting photos.

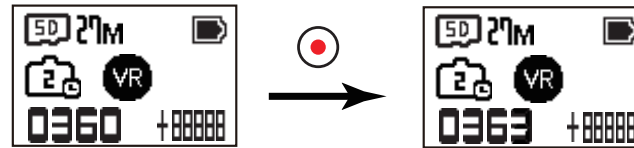



■ Loop Recording Mode

Loop recording refers to recording independent video segments in the unit of 2 minutes. The recording will be automatically stopped if the single recording time exceeds 24 hours.

Operation method:

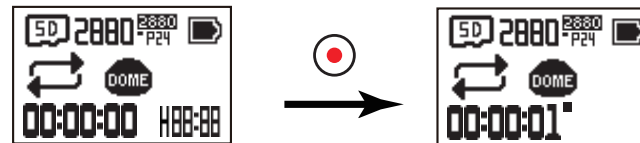
Press the  button to start recording. Press the  button again to stop recording.



 The video recording time varies in accordance with different capacities of memory card and movie size. Each time loop recording is executed, a new folder is generated.

■ Time-Lapse Video Mode

Time-lapse movie enables the recording of an interval of time, and splices the frames together to present a condensed video, which usually requires a long period to complete.

Operation method:

Press the  button to start recording. Press the  button again to stop recording.

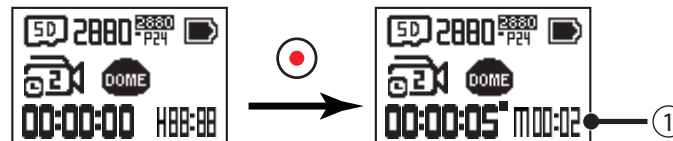

① indicates that the current countdown seconds

 Neither sound recording nor electronic image stabilization (EIS) function are supported.

■ High-Speed Movie Mode

This camera shoots ultra-high speed movies and plays back with normal 30fps speed.

Operation method:

Press the  button to start recording. Press the  button again to stop recording.

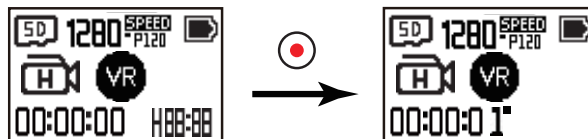

 Audio cannot be recorded in this mode.

■ Burst Mode





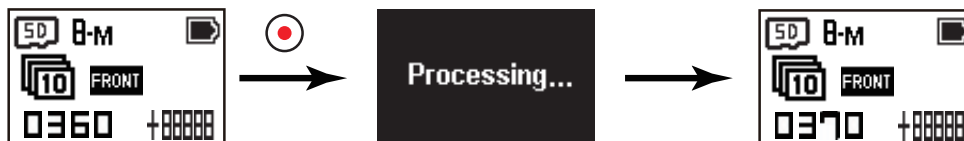

Enables ten successive photos to be captured continuously before automatically pausing.

Operation method:









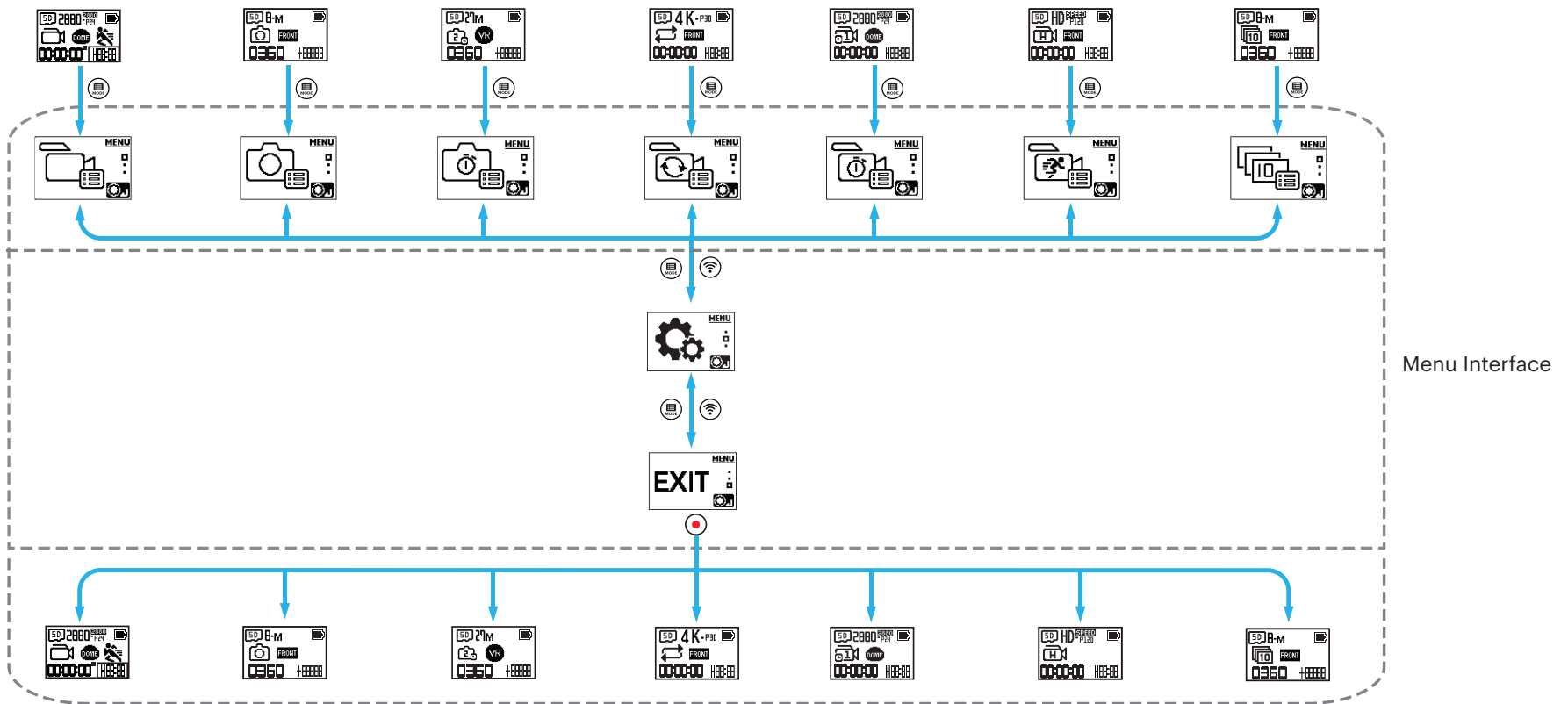

Press the  button; the camera will pause after 10 photos have been taken.



Menu Introduction:

1. In the main camera interface, press and hold the  (up) button to enter the interface menu. There are 2 options: All Shooting Mode Settings ( / ) and General Settings . Press the  (up) or  (down) button to select the desired setting and press the  button to enter the corresponding sub-menu interface.



2. Toggle between the  (up) or  (down) buttons to select the desired setting; press the  button to confirm and to enter the selected menu interface (highlighted with a black background color).
3. Press the  (up) or  (down) buttons to select the desired item; press the  button to select and confirm and to go back to the sub-menu interface.
4. Select , press the  button to return to the menu interface.
5. Select , press the  button to return to the main menu interface.

All Shooting Mode Settings

The Sub Menu for all shooting modes and settings:

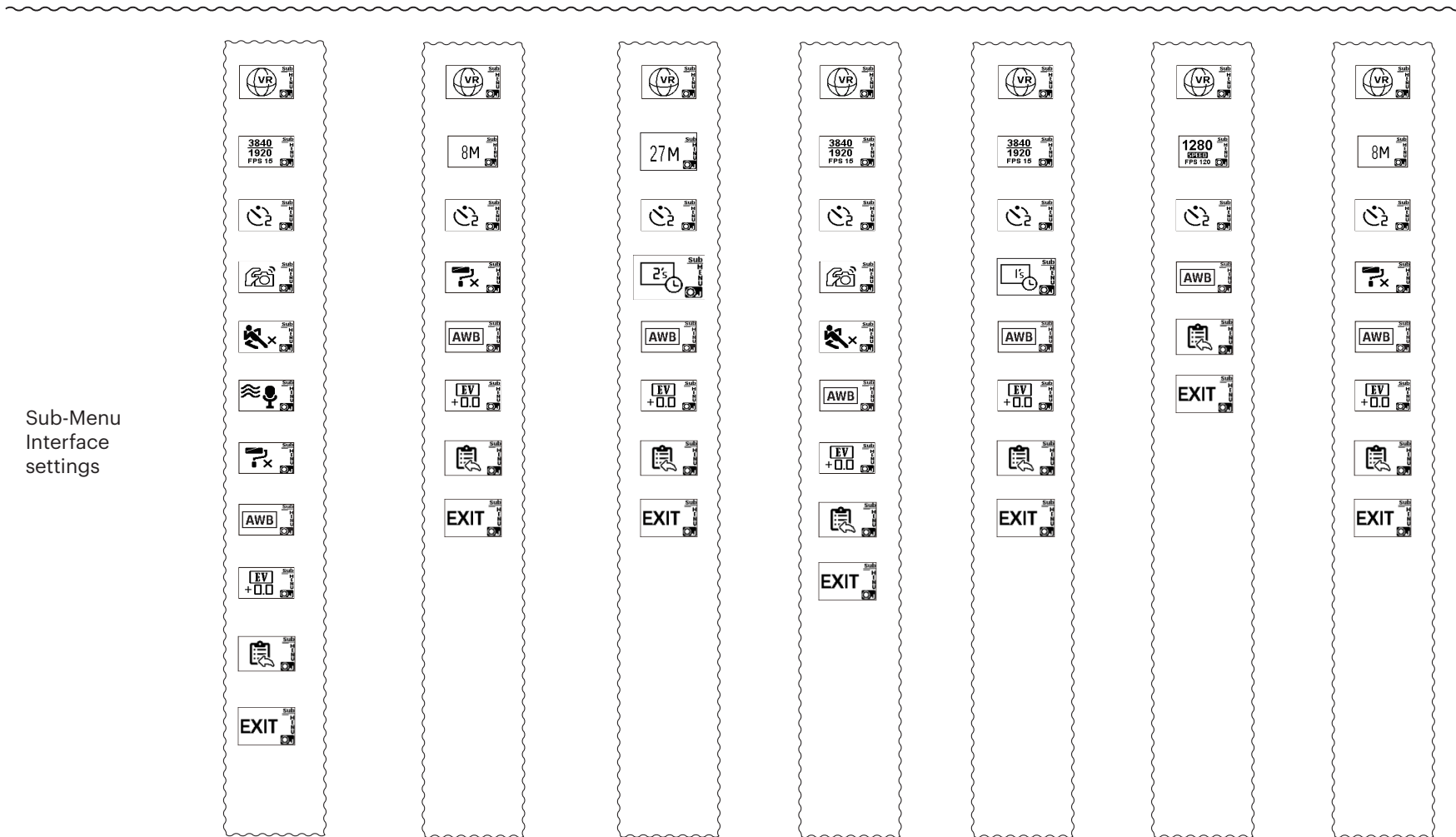
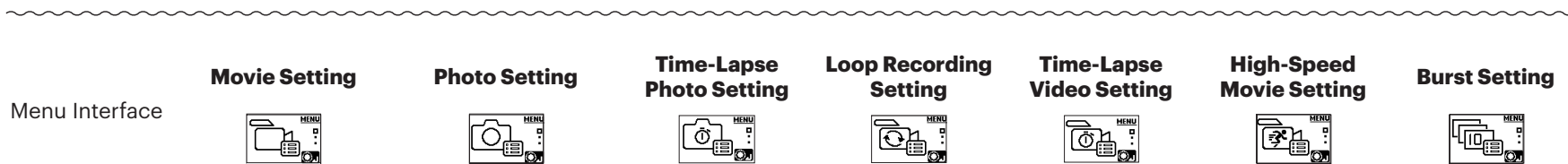

Below is an illustration of the recording setting menu for an example. The operating settings of all optional shooting modes have the same menu entry flow and menu access as shown below:

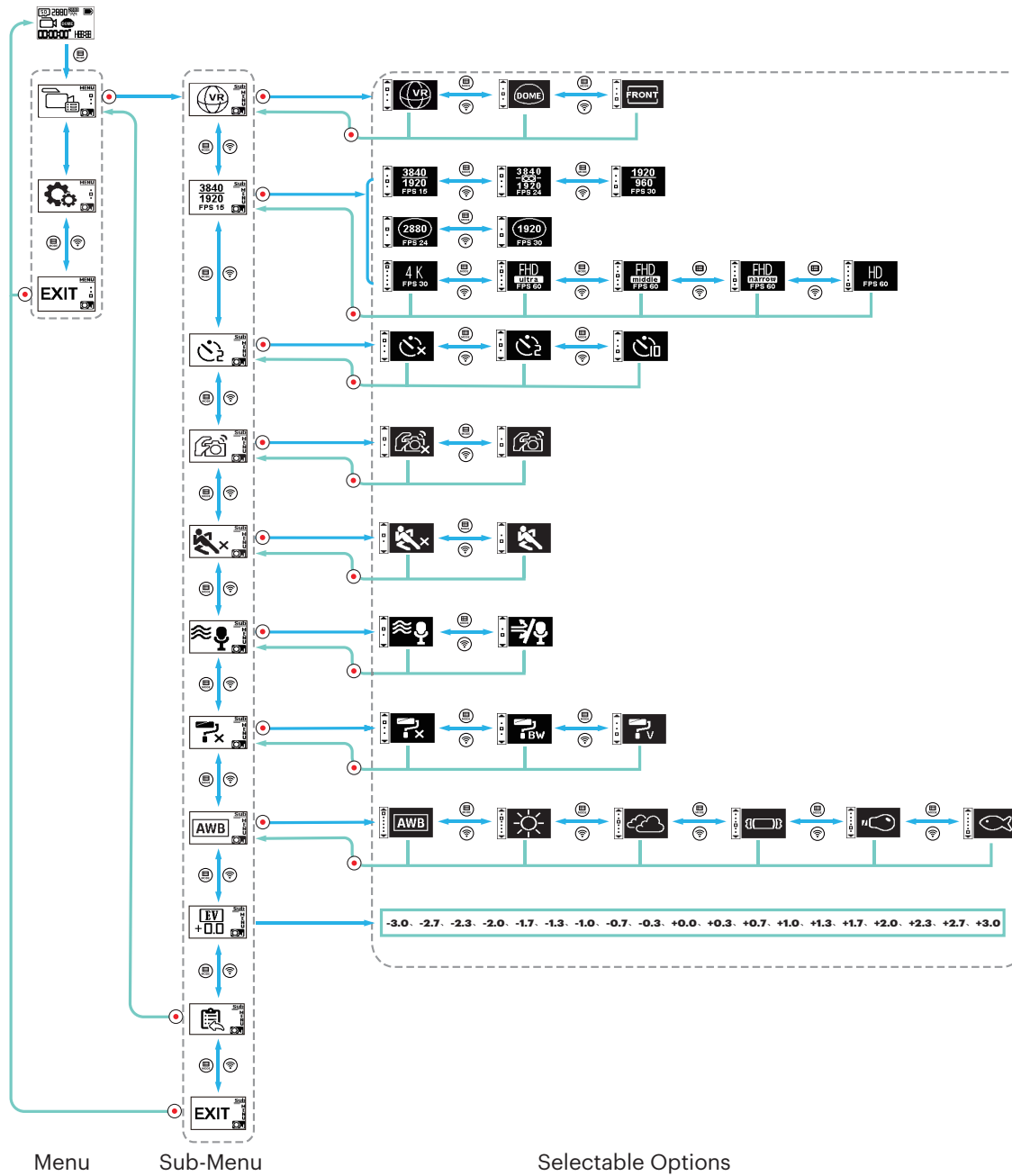

■ Display Mode

Set image storage format.

There are 3 options:

1.  360° Spherical / VR Mode

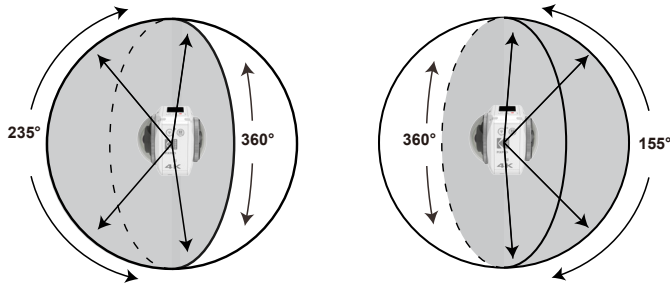

Stitched



Global



 Camera cannot stitch correctly while shooting an object nearby.

2. **DOME** 235° Round (Dome) Mode

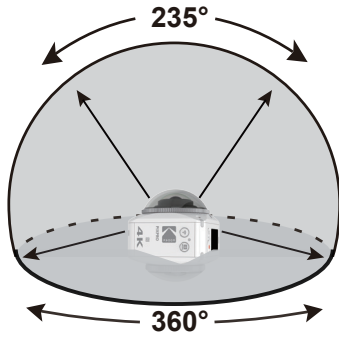

3. **FRONT** 197° 4K Ultra Wide Full Frame Mode [16:9]
4K [16:9] Full Frame Mode

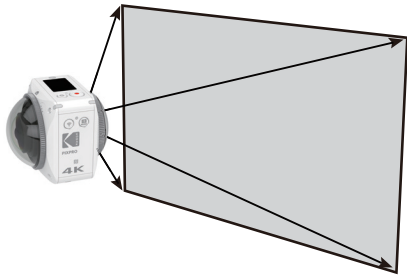

■ Movie Size

Video Resolution Settings:

VR 360° Spherical / VR Mode (2:1)

• **3840-[∞]P24** 3840×1920 (24fps)

• **3840-¹⁸²⁰P15** 3840×1920 (15fps)

• **1920-⁹⁶⁰P30** 1920×960 (30fps)

• **1280-^{SPEED}P120** 1280×640 (120fps)

235° Round (Dome) Mode (1:1)

• **2880-²⁸⁸⁰P24** 2880×2880 (24fps)

• **1920-¹⁹²⁰P30** 1920×1920 (30fps)

197° 4K Ultra Wide Mode

• **4K-P30** 3840×2160 (30fps)

• **FHD-^{Ultra}P60** 1920×1080 (60fps)

• **FHD-^{middle}P60** 1920×1080 (60fps)

• **FHD-^{narrow}P60** 1920×1080 (60fps)

• **HD-P60** 1280×720 (60fps)

• **HD-^{SPEED}P120** 1280×720 (120fps)

 The selectable video resolution options vary for different video shooting modes and are subject to actual user selections that will determine final playback and the saved video file resolution.

 When the display mode is set to **VR**, the only options available will have the [2:1] aspect ratio and will be displayed; when the display mode is set to **FRONT**, only the [16:9] options will be displayed; when the display mode is set to **DOVE**, only the [1:1] aspect ratio options will be displayed.

 When selecting **4K-P30** during recording, if the lenses face toward a harsh or brighter light, a glow effect may occur.

 The maximum recording times are:

Movie size	4GB	8GB	16GB	32GB	64GB	128GB	256GB
3840-[∞]P24	00:07:00	00:16:00	00:31:00	01:05:00	02:10:00	04:21:00	08:42:00
3840-¹⁸²⁰P15	00:07:00	00:16:00	00:31:00	01:05:00	02:10:00	04:21:00	08:42:00
1920-⁹⁶⁰P30	00:28:00	00:57:00	01:52:00	03:51:00	07:43:00	15:28:00	30:58:00
1280-^{SPEED}P120	00:18:00	00:37:00	01:13:00	02:31:00	05:03:00	10:07:00	20:15:00
2880-²⁸⁸⁰P24	00:07:00	00:16:00	00:31:00	01:05:00	02:10:00	04:21:00	08:42:00
1920-¹⁹²⁰P30	00:14:00	00:29:00	00:56:00	01:57:00	03:55:00	07:50:00	15:42:00
4K-P30	00:07:00	00:16:00	00:31:00	01:05:00	02:10:00	04:21:00	08:42:00
FHD-^{Ultra}P60	00:18:00	00:37:00	01:12:00	02:30:00	05:00:00	10:01:00	20:04:00
FHD-^{middle}P60	00:18:00	00:37:00	01:12:00	02:30:00	05:00:00	10:01:00	20:04:00
FHD-^{narrow}P60	00:18:00	00:37:00	01:12:00	02:30:00	05:00:00	10:01:00	20:04:00
HD-P60	00:30:00	01:00:00	01:58:00	04:05:00	08:11:00	16:24:00	32:51:00
HD-^{SPEED}P120	00:21:00	00:43:00	01:25:00	02:56:00	05:52:00	11:46:00	23:34:00

 File size may increase or decrease depending on the subject, shooting conditions, etc. Disc capacity varies with manufacturer and formatting method. The exposure time may be used for reference.

■ Self Timer:

Setting the self-timer function:

There are 3 options:



-  Self Timer - Off
-  Self Timer - 2 sec
-  Self Timer - 10 sec

■ Electronic Image Stabilization (EIS):

Setting the Electronic Image Stabilization (EIS) function:

There are 2 options:

-  Enable
-  Off



Shooting Modes	Number of Recording Pixels	EIS Setting		
Still	7360x3680	360°	360°	-
	5520x2760	360°	360°	-
	7360x3680	360°	360°	-
	5520x2760	360°	360°	-
	3680x3680	235°	235°	-
	3526x2644	197°	197°	-
	3840x2160	197°	197°	-
Movie	3840x1920 15fps	360°	360°	-
	3840x1920 24fps	360°	360°	-
	1920x960 30fps	360°	360°	-
	2880x2880 24fps	235°	235°	207°
	1920x1920 30fps	235°	235°	207°
	3840x2160 30fps	197°	197°	172°
	1920x1080 60fps	197°	197°	172°
	1920x1080 60fps	155°	155°	140°
	1920x1080 60fps	100°	100°	91°
	1280x720 60fps	67°	67°	61°
Hi Speed Movie	1280x640 120fps	360°	360°	-
	1280x720 120fps	197°	197°	-

When the camera is set in VR Mode, the EIS setting is not available.

■ Time-Lapse Photo:

Set interval photo time.

There are 6 options:

-  1 sec
-  2 sec
-  5 sec
-  10 sec
-  30 sec
-  60 sec

■ Time-Lapse Video:

Set interval recording time.

There are 6 options:

-  1 sec
-  2 sec
-  5 sec
-  10 sec
-  30 sec
-  60 sec



■ Motion Detection:

Motion detection means if the camera detects moving objects entering into view, it will automatically start recording. During the recording process, if there is no moving object detected for 10 continuous seconds, the recording will pause automatically.

There are 2 options:

-  Enable
-  Off

Operation method:

1. Select  and return to the main menu interface.
2. The display will show the  icon. Press the  button to activate. When the product detects moving objects, it will automatically start recording.
3. The product will stop recording when there is no change in the image or lack of movement after 10 seconds. When the image changes or the camera senses movement again, the camera will start recording again automatically and a new video file will be generated after each pause and restart.

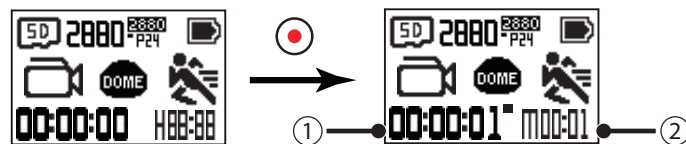

① indicates the total time of recording

② indicates the total time from enabling the Motion Detection setting

4. Press the  button to stop recording and detecting.

■ Wind Reduction:

Wind reduction refers to the camera's ability to reduce the amount of noise caused by wind or high speed recording environments.

There are 2 options:

-  Enable
-  Off

■ Color:

Set Image Color.

There are 3 options:

-  Normal
-  Black and White
-  Vivid

■ White Balance:

White balance means the user can adjust the color temperature under different light sources to help ensure that the colors in photos and videos are reproduced as accurately as possible.

There are 6 options:

-  Auto White Balance
-  Daylight
-  Cloudy
-  Fluorescent
-  Incandescent
-  Underwater







■ Exposure Compensation:

Adjust picture brightness. The adjustable range of the camera's exposure compensation value is from EV -3.0 to EV +3.0.







■ Photo Size:

Set photo resolution.

There are 7 options:

-  7360×3680(2:1)
-  5520×2760(2:1)
-  7360×3680(2:1)
-  5520×2760(2:1)
-  3680×3680(1:1)
-  3526×2644(4:3)
-  3840×2160(16:9)

 Number of photos that can be stored:

Photo size	4GB	8GB	16GB	32GB	64GB	128GB	256GB
 27M	553	1111	2167	4465	8854	17732	35487
 15M	950	1907	3720	7666	15218	30477	60994
 27M	553	1111	2167	4465	8854	17732	35487
 15M	950	1907	3720	7666	15218	30477	60994
 13M	1059	2125	4144	8540	16792	33630	67304
 9-M	1472	2954	5761	11872	23189	46441	92944
 8-M	1631	3274	6384	13156	25630	51330	102728

 File size may increase or decrease depending on the subject, shooting conditions, etc. Disc capacity varies with manufacturer and formatting method. The exposure time may be used for reference.

General Settings

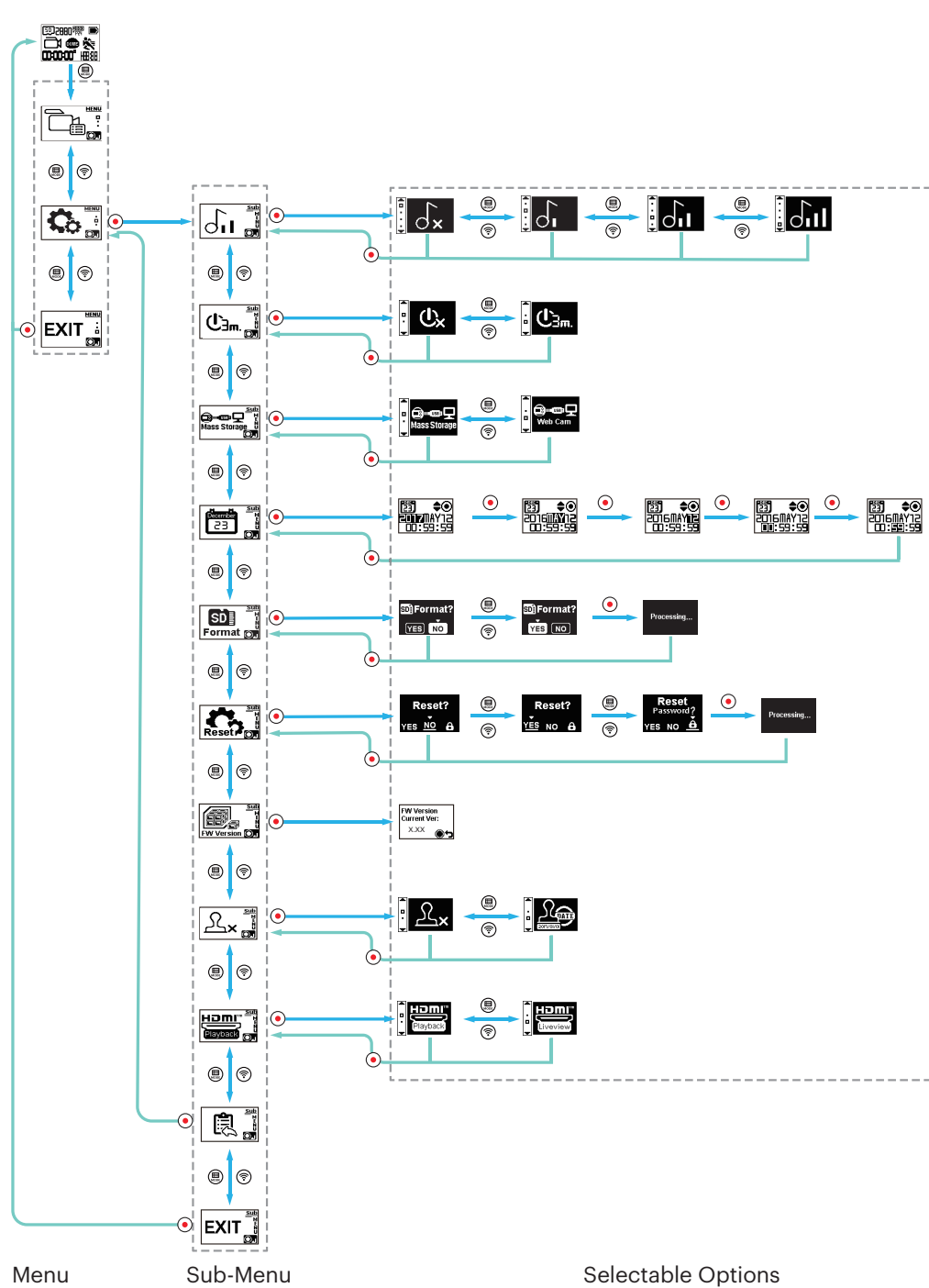

Menu

Sub-Menu

Selectable Options

■ Audio / Sound

Set the audio / sound levels of the camera.



There are 4 options:

-  Sound Off
-  Sound 1
-  Sound 2
-  Sound 3

■ Automatic Power Off

When this function is enabled, if there is no action taken within a set time frame (except while recording or connected to Wi-Fi), the camera will automatically power off.

There are 2 options:

-  3 minutes
-  Off

■ USB Connection Mode

The mode of connecting the camera via a Micro USB cable to a computer is available. If there is a need to view, save photos or videos, please select the "Mass Storage" mode from the menu settings. If there is a need for the camera to serve as a video chat (SKYPE) device, please select the "Webcam" option.





There are 2 options:

-  Mass Storage
-  Webcam

 When the Webcam is being used, the power can only be supplied by the camera's internal Li-ion battery, so a fully charged battery is highly recommended.

■ Date / Time

Set the date and time in the camera.

1. The display shows the date and time setting screen, "Year, Month, Day, Hour : Minute : Second";
2. The field to be adjusted will be highlighted with a black background color. Press the  (up) or  (down) button to adjust the value, press the  button to confirm value.
3. After adjusting the "Minute" value, press the  button to enter the Sub-Menu Interface.



■ **Format**

Format will clear all data stored on the memory card and will fully erase all photos and videos stored on the card.

There are 2 options:

- **YES** Confirm
- **NO** Cancel

To select **YES**, press the  button to start formatting the card and return to the sub-menu interface after completion.

■ **Reset Settings**

Reset settings will recover and reinstall all standard product settings to the factory defaults (except for date and time).

There are 3 options:

- **YES** Confirm
- **NO** Cancel
-  Reset Password

If select **YES**, press the  button to start reset and return to the sub-menu interface after completion.

■ **FW Version**

The FW version will display the current firmware version installed on your camera. Press the  button to return to the sub-menu interface.

If there is a new version stored in a folder firmware on the memory card, the firmware can be updated by inserting the memory card and updating the firmware.

There are 2 options:

- **YES** Confirm
- **NO** Cancel

If select **YES**, press the  button to start updating the new firmware and the camera will automatically power off after completing and installing the firmware update.

 If the low battery warning appears, fully charge the battery before reattempting to update the firmware.

■ **Date Stamp**

Include a date stamp on the photo image.

There are 2 options:

-  Date Stamp_On
-  Date Stamp_Off



 **27M / 15M / 13M** will not allow a date stamp on the photo images.

BLUETOOTH Remote Control-D

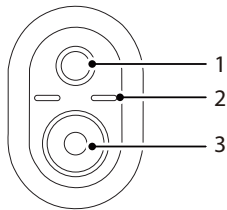

Remote Control View



1.  BLUETOOTH Signal Test Button
2. Connect / Shooting Indicator
3.  Recording / Shooting Button

Specifications

Model: RR-BK04

Dimension: 30×20×13.7mm

Weight: 27±2g (including battery)

Dust Proof: IP6X

Temperature: -10° to 40°C

Humidity: 0-90%

Battery: Button Cell CR2032

Before Using:

Pull the insulating strip completely out prior to operating the remote control.



Installing the Battery:

Use a screwdriver to remove the screw on the backside of the remote control by turning it counterclockwise (Fig. 1). Open the battery cover and insert the battery (Fig. 2), close the battery cover and rotate the screw in the opposite direction to tighten down.

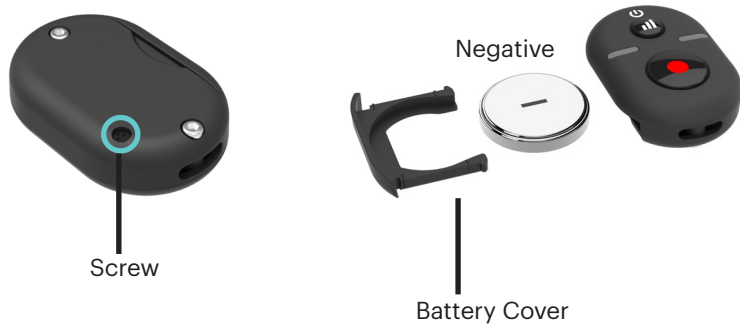

Installation of the Remote Control Mount-B /Mini Remote Control/3-Leg Stand:

1. Press the Mini Remote Control mount onto the 3-Leg Stand (Fig. 1). Close the tripod (Fig. 2).
2. To mount the Mini Remote Control and align it between the two location holes at the bottom of the mount (Fig. 3), align the remote control with the two locating points at the top of the mount (Fig. 4), and snap into place.



 If the tripod is loose, tighten it with the supplied Hex Wrench.



(1)



(2)



(3)



(4)

Pairing the Camera Via BLUETOOTH Remote Control:

1. Pair the camera to the remote control

This method is for one remote control to one camera:

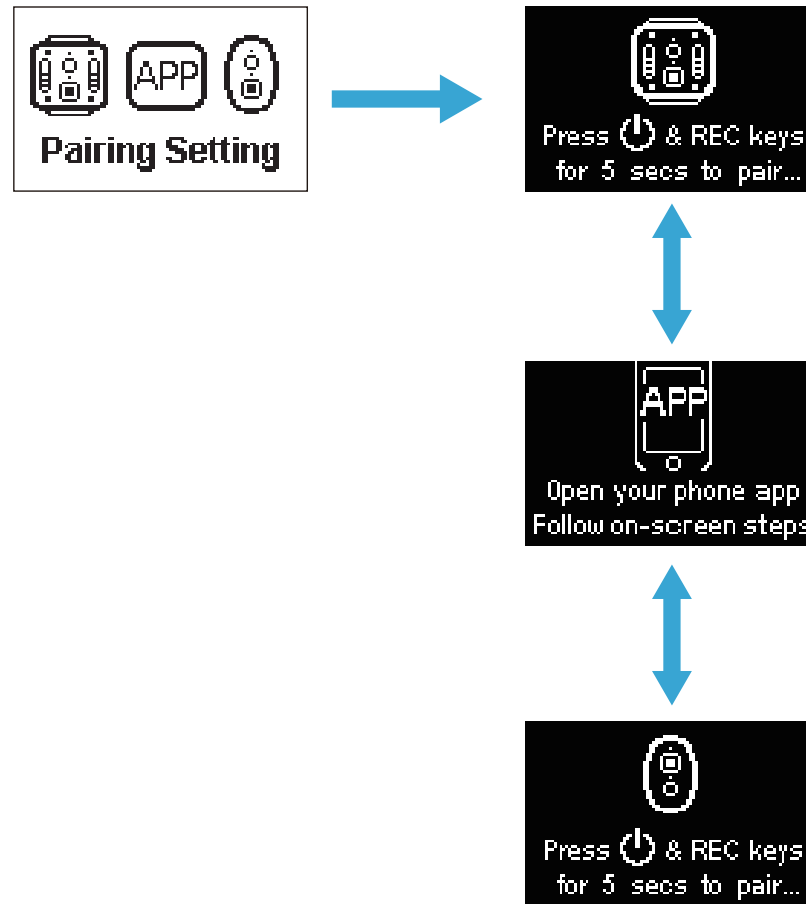

With the camera turned on, press the  button for 2 seconds to enter the pairing mode.

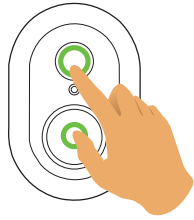

Press and hold the  and  buttons simultaneously on the remote control until pairing is successful.

 While attempting to pair, the remote control should be held close to the camera.







2. Press the  button on the remote control to start shooting or recording and press the  button again to stop recording.



 Other parameters in the camera will remain the same as initially set.

3. To terminate remote control pairing, press the  button.

Successful Pairing Between the Camera and the Remote Control:

1. BLUETOOTH signal test press the  button. The camera will power off or on by pressing and holding the  button for 1.5 seconds or more.
2. Using the mini remote control, all settings or parameters set in the camera's menus for shooting or recording will remain the same as initially set.
 -  Upon successful pairing, both the remote control and camera will remember the BLUETOOTH information.
 -  When camera is activated prior to remote control after pairing with remote control, press and hold the signal button on the remote control to reconnect. When successfully reconnected, the green LED signal light will flash in green.
 -  If the camera has been powered off for more than 12 hours, it is impossible to power on the camera directly with remote control.

Indicator Lamp Status Description:

1. If pairing is successful, the signal indicator light will turn green.
2. If pairing fails, the signal indicator lamp will turn red.
3. When recording or shooting with the Mini Remote Control, the shooting status indicator lamp will turn red.
4. When the remote control's battery level is less than 20%, the indicator light will turn orange.

Precautions:

1. If the Wi-Fi, NFC or HDMI connection or computer connection with the camera are enabled, the remote control function is not available.
2. The remote control operates at band 2.4GHz. Because microwave ovens, radios and amateur radios also use the same cyclic wave, it is possible to experience radio interference.
3. Before using the remote control, please make sure there are no other electronic devices or radio stations, etc. around. Please use the camera and remote control in an environment with better permeability and free from obstructions.
4. Radio interference and other circumstances may cause a malfunction of the remote control. Pay attention to the actual conditions of the camera when using the remote control.

BLUETOOTH Remote Control-C



This remote control device can be used to remotely control the camera from a distance.

The remote control is optional. If you wish to purchase one, contact your retailer to buy or visit kodakpixpro.com for our online store.

The optional wrist strap is provided to wear the remote control if desired.

Remote Control View

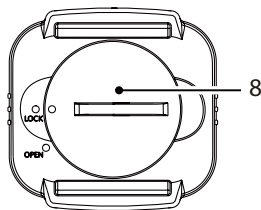
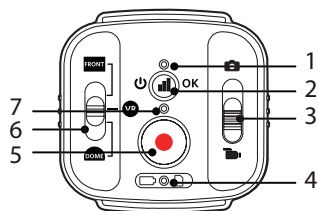

1. Signal Indicator Lamp
2.  BLUETOOTH Signal Test Button
3. Shooting Mode Switch
4. Battery / Memory Card Indicator Light
5.  Recording / Shooting Button
6. VR 360° / Front 197° / Dome Mode 235° Mode Switch
7. Shooting Status Indicator Lamp
8. Battery Cover Plate

Specifications

Model: RR-WH03

Dimension: 46.9 × 46.1 × 13.7mm

Weight: 28g (including battery)

Waterproof: 5m (16 feet)

Shockproof: 2m (6.5 feet)

Dustproof: IP6X

Temperature: -10° to 40°C

Humidity: 0-90%

Battery Type: Button Cell CR2450

Installing the Battery:

Open the battery cover plate with the included accessories tool in a counter clockwise direction. Insert the battery with the anode facing upward. Replace cover CR2450 plate over battery and turn clockwise to lock into place.

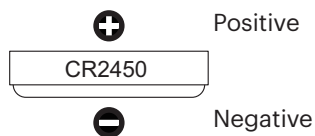
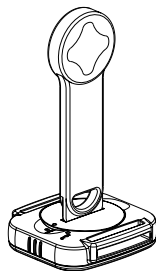



Pairing the Camera Via BLUETOOTH Remote Control:

1. Pair the camera to the remote control

This method is for one remote control to one camera:

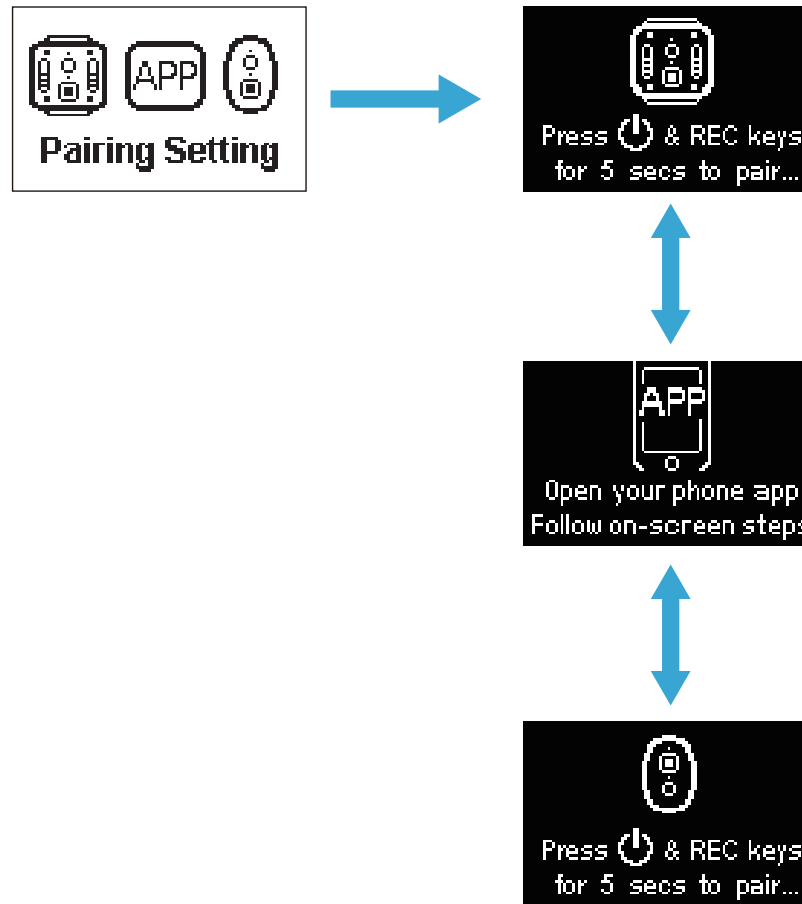
With the camera turned on, press the  button for 2 seconds to enter the pairing mode.



Press and hold the  and  buttons simultaneously on the remote control until pairing is successful.

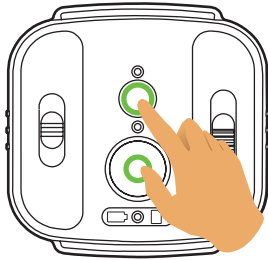

While pairing, the remote control should be held close to the camera.

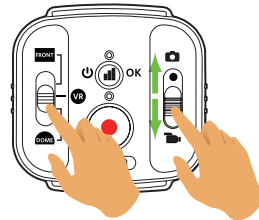

2. Set the desired shooting mode (movie mode  or snap / shot photo mode ) and the display mode (VR , Round (Dome)  or Front )









Other parameters are set the same as the current settings of the camera at the same mode.

3. Press the  button on the remote control to start shooting or recording and press the  button again to stop recording.



After successful pairing, if you press the  button, the remote control and the camera need to be re-paired.

Successful Pairing Between the Camera and the Remote Control:

1. To test if the camera's powered on or whether the remote control is paired successfully, press the  button. The camera will power off by pressing and holding the  button for more than 1.5 seconds.
2. When the  button on the remote control is pressed to start recording or shooting, the camera will work with the current setting of the remote control.
 -  Upon successful pairing, both the remote control and camera will remember the BLUETOOTH information.
 -  When camera is activated prior to remote control after pairing with remote control, press and hold the signal button on the remote control to reconnect. When successfully reconnected, the green LED signal light will flash in green.
 -  If the camera has been powered off for more than 12 hours, it is not possible to power the camera on directly with remote control.

Indicator Lamp Status Description:

1. If pairing is successful, the signal indicator light will turn green.
2. If pairing fails, the signal indicator lamp will turn red.
3. During remotely controlled recording or shooting, the shooting status indicator lamp will turn orange.
4. When the battery level of the camera is less than 25% or the memory card is full, the battery/memory card indicator lamp will turn red.

Precautions:

1. If the Wi-Fi, NFC or HDMI connection or computer connection with the camera are enabled, the remote control function is not available.
2. The remote control operates at band 2.4GHz. Because microwave ovens, radios and amateur radios also use the same cyclic wave, it is possible to experience radio interference.
3. Before using the remote control, please make sure there are no other electronic devices or radio frequencies, etc. around. Please use the camera and remote control in an environment with better permeability and free from obstructions whenever possible.
4. Radio interference and other circumstances may cause a malfunction of the remote control.

User Interface

Micro USB Interface



Charging Your Camera:



Using an External Power Supply

In the case of low battery power or when a long-term power supply is needed, an external power supply (AC adapter, vehicle power supply, portable power supply or other power unit) can be used instead of a battery. The camera settings for functions, photography and other operation can be performed normally.

When powered on, use the Micro USB cable to connect the camera to an external power supply. When connected with an external power supply, this icon  will be displayed on the camera's LCD.

When powered off, use the Micro USB cable to connect the camera to the external power supply. Press the  button to power on. When connected to an external power supply,  will be displayed on the camera's LCD.



Requirements for the external power supply: output power of 5 V, output current of 1 A.





Insert the battery into the camera before using an external power supply to charge the camera.

Data Transmission

Use the Micro USB cable to connect the camera to a computer and copy files from the camera to the computer.

The steps are as follows:

1. Set the USB connection mode to  in the camera menu.
2. Use the Micro USB cable to connect a computer (on) to the camera (on). During the connection, the camera will display "" and the computer will automatically detect the camera.

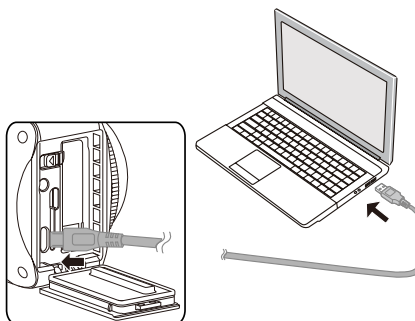

3. Open the camera folder on the computer to copy your files to the computer's hard drive. After the transmission is complete, please unplug the USB cable in a safe manner according to the computer's settings and operation manual.
4. The camera will automatically power off when the Micro USB cable is unplugged.



Your computer operating system version needs to be Mac OS X10.9 and above or Windows 7 and above.

The folder structure of a microSD card on which this camera has performed recording is as follows:

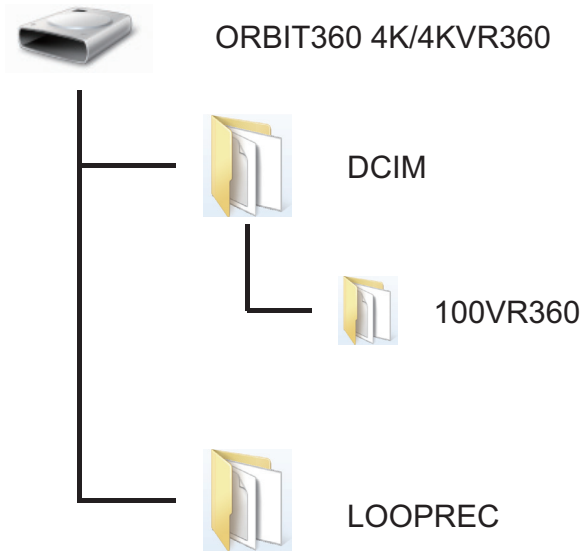

- Folder numbers range from 100 to 999. Four alphabetic characters indicate the camera lens type. Five or eight alphabetic characters indicate the file type. The character shows the camera lens type used in the shot:

VR: 360° Spherical / VR Mode : _

Dome: 235° Round (Dome) Mode: R

Front: 197° 4K Ultra Wide Mode: F

- VR files formatted (Each folder stores a maximum of 9999 still pictures)
Still pictures in .jpg format
Movie files in .mp4 format
- Loop Recording videos can only be viewed and downloaded by PC.
Movie files in .mp4 format

 The size of a video file may not exceed 4GB. If the size is over 4GB, it will be saved as a separate file.

 To simulate a 360° viewing experience while previewing videos recorded by the ORBIT360 4K/4KVR360, use the PIXPRO 360 VR Suite, available for Mac and PC's.





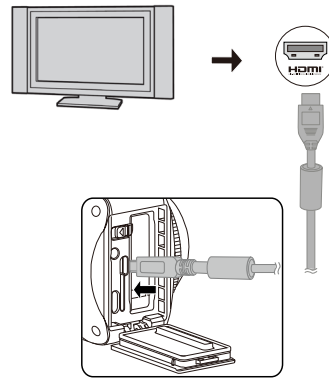

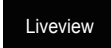
Micro HDMI Interface:

To connect your camera to a TV, use a Micro HDMI cable (sold separately).







After the connection is successful, the files on the memory card of the camera should be displayed on the television, while  or  is displayed on the camera's LCD.

Shooting and Playback Functions on the Camera:

1. Press and hold the  button to switch between the video playback mode and the shooting modes.
2. Press the  (up) or  (down) buttons to browse the folders and files in the playback modes.
3. Press the  button to start playing videos and photos and press the  button again to stop playing while in the recorded folders and files.
4. Set the camera parameters according to requirements in the menu first while in the shooting mode. Then return to the main camera screen, press the  button to shoot or start recording and press the  button again to stop recording.

 In the live view mode, the frame rate depends on the video settings.

Playback Functionality from your TV's and Remote Control:

1. Press the left and right keys to switch between the folders and files on your camera's Micro SD card.
2. Press the  button to return to main menu.
3. Press the  button to hide or display the TV screen information.
4. For browsing the video folders and files, press the TV remote control central key to start playing, press the left arrow to fast reverse, press the right arrow to fast forward and press the central button again to pause playback.
5. Press the  button to delete the current file and select  to confirm deletion.
6. Press the  button to stop playing.

 Only HDMI televisions having the Consumer Electronics Control (CEC) function can support this function.

Download and Install APP

● Smart Devices:

Download the APP installation package (APP name: PIXPRO 360 VR Remote Viewer)  to your smart device from the path below and install it by following the instructions on the interface.

For ANDROID devices, search and download the APP "PIXPRO 360 VR Remote Viewer" in Google Play and install it by following the instructions on your smart device's interface.



For iOS devices, search and download the APP "PIXPRO 360 VR Remote Viewer" in APP Store and install it by following the instructions on your smart device's interface.



● Personal Computers:

Download the "PIXPRO 360 VR Suite" (for Mac or Windows) installation package  from the official KODAK PIXPRO website and install it on your computer by following the prompts on the interface.

Americas



<http://kodakpixpro.com/Americas/support/downloads.php>

Europe



<http://kodakpixpro.com/Europe/support/downloads.php>



Please review the following items before your first time connecting:

1. Do not use in places with high intensity magnetic fields, electrostatic and electric wave interference (for example near a microwave oven), which may or may not cause failure in receiving proper signals.
2. Do not use the Wi-Fi or NFC connection or functions on an airplane.
3. To maintain your connection, please keep the ORBIT360 4K/4KVR360 within 32.8 feet (10 meters) without signal shielding interference.
4. The ORBIT360 4K/4KVR360 and the smart device can only be connected one to one.
5. The ORBIT360 4K/4KVR360 and personal computer can only be connected one to one.
6. Your smart device operating system version needs to be iOS 9 or higher on Mac or ANDROID 5.0 or higher. iPad mini1 / iPad 4 / iPad Air 1 / iPhone 5s and earlier models (any system versions) will not support this APP.
7. Your computer operating system version needs to be OS X10.9 on Mac and Windows 7 and above.

Connecting your Camera to Smart Device (or Personal Computer) with Wi-Fi:

Operation Method:

1. Camera:

Check SSID (Service Set Identifier) (PIXPRO-ORBIT360_XXXX / PIXPRO-4KVR360_KXXXX) and password (initial password: 12345678) indicated on the label in the battery compartment of the camera. Press the  button to enable Wi-Fi mode. The camera will enter the pending connection mode interface two seconds later:



3. Camera:

When the Wi-Fi connection is successful, enter the Wi-Fi connection interface.



5. Camera:

When the APP is connected to the camera, the APP connection interface will appear.



When recording has started via the APP, the recording interface will appear on the camera's LCD.





2. Smart Device or Personal Computer:

When you enable Wi-Fi mode, the camera will automatically search nearby Wi-Fi hotspots. Select the one with the same SSID (PIXPRO-ORBIT360_XXXX / PIXPRO-4KVR360_KXXXX) and input the camera's password. (Default Password: 12345678)



4. Smart Device or Personal Computer:

When connected via Wi-Fi, you can tap the APP icon  on the smart device to start it; or double-click the APP icon  on the desktop of your computer to start it.

④ If the Wi-Fi connection is dropped while recording, the camera will continue to record and will enter the connection free recording mode.



④ When  displays in the interface, press the  button and press the  (up) or  (down) button to select **YES**. Then press the  button to exit the Wi-Fi connection mode.

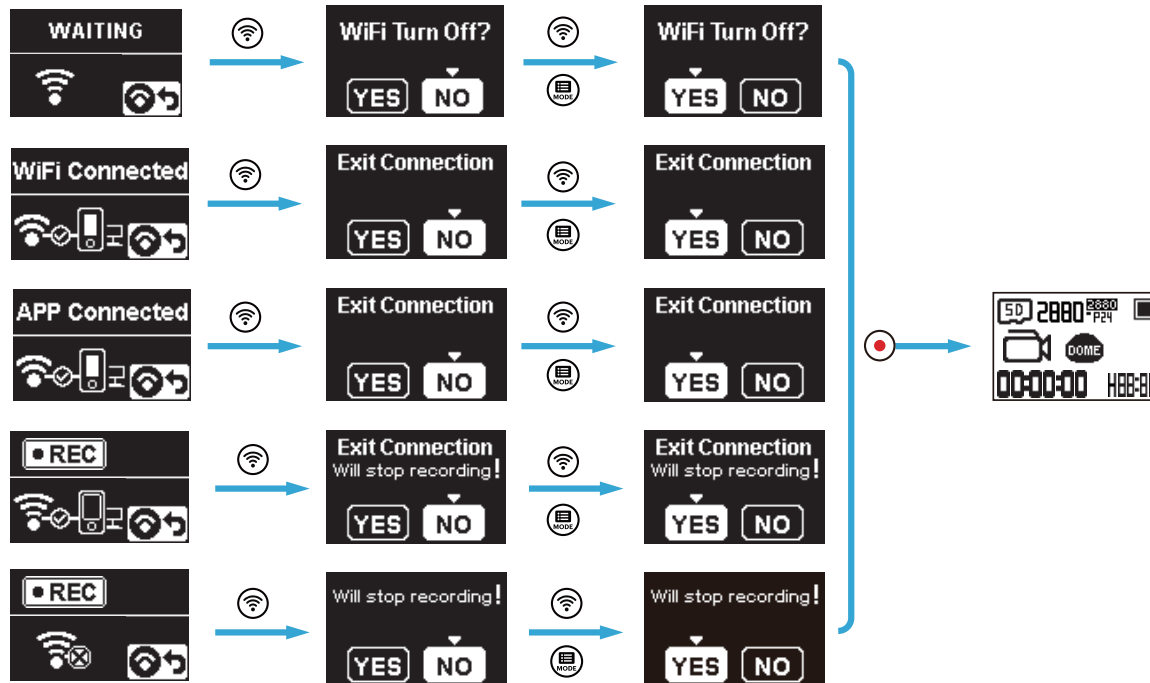

Connecting Camera to Smart Device with NFC

1. These instructions are to enable NFC connection on your smart device.
2. Use your smart device to lightly touch the NFC mark on the ORBIT360 4K/4KVR360 camera. If the smart device has a prompt tone or vibration that means the connection is successful.

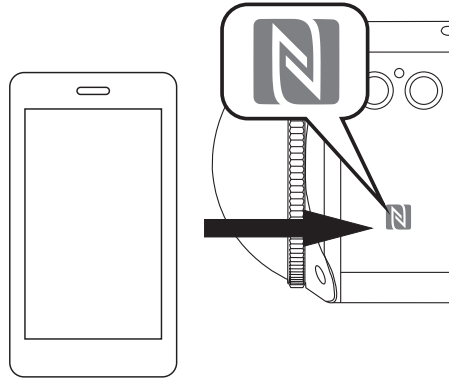

3. The APP will automatically open on your smart device.

 The NFC feature is only available when your smart device's screen is unlocked.

Appendices

Specifications:









 Design and specifications are subject to change without notice.





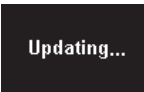

Image Sensor A	Type	1/2.3" BIS CMOS
	Effective Pixels	20.68 Megapixels
	Total Pixels	21.14 Megapixels
Lens A	Focal Length	1.633mm
	Equivalent to 35mm film	9.18mm
	F Number	F2.4
	Lens Construction	7 groups 8 elements
	Focus	Fix Focus
	Field of View	Max. 197 Degrees (For Front Mode [16:9])
		Max. 155 Degrees (For VR Mode [2:1])
Focusing Range	30cm~∞	
Image Sensor B	Type	1/2.3" BIS CMOS
	Effective Pixels	20.68 Megapixels
	Total Pixels	21.14 Megapixels
Lens B	Focal Length	1.257mm
	Equivalent to 35mm film	7.08mm
	F Number	F2.4
	Lens Construction	7 groups 8 elements
	Focus	Fix Focus
	Field of View	Max. 235 Degrees
	Focusing Range	30cm~∞
Anti-Handshake	Electronic Image Stabilization (EIS)	

Number of Recording Pixels	Still Image	27MP: 7360x3680 (2:1)	Stitched	VR Mode / 360° Spherical	
		15MP: 5520x2760 (2:1)			
		27MP: 7360x3680 (2:1)	Global		
		15MP: 5520x2760 (2:1)			
		13MP: 3680x3680 (1:1)	Round (Dome) Mode / 235° Dome		
		8MP: 3840x2160 (16:9)	Front Mode / 197° 4K Ultra Wide		
		9MP: 3526x2644 (4:3)			
	Movie	(2:1)	VR Mode / 360° Spherical		
		3840x1920/24fps			Global
		3840x1920/15fps			Stitched
		1920x960/30fps			
		(1:1)	Round (Dome) Mode / 235° Dome		
		2880x2880/24fps			
		1920x1920/30fps			
		(16:9)	Front Mode / 197° 4K Ultra Wide		
		3840x2160/30fps			
		1920x1080/60fps			Ultra
		1920x1080/60fps			Middle
		1920x1080/60fps			Narrow
		1280x720/60fps			
High-speed Movie :					
1280x640/120fps(2:1)	VR Mode / 360° Spherical				
1280x720/120fps(16:9)	Front Mode / 197° 4K Ultra Wide				
File Format	Still Image	Exif 2.3 (JPEG)			
	Movie	MP4 [Image: H.264; Audio: AAC(Stereo)]			
Camera Modes	VR Mode (Lens A and Lens B), Round (Dome) Mode (Lens B), Front Mode (Lens A)				
Shooting Modes	Photo, Hi-Speed Movie, Movie, Burst				
Splash proof	Equivalent to JIS/IEC IPX5 (Body)				
Shockproof	Up to 2m (with lens cover)				
Dustproof	Equivalent to JIS/IEC (IP6X)				

Freeze-proofing	-10°C	
LCD	1.0 inch TN LCD (With Backlight)	
Level Gauge	3 Axis	
ISO Sensitivity	Auto (100-1600) (Photo)	Auto (100-800) (Movie)
Exposure Metering Method	Artificial Intelligence AE (AiAE)	
Exposure Control Method	Program AE	
Burst	Supported	
White balance	Auto White Balance, Daylight, Cloudy, Fluorescent, Incandescent, Underwater	
Recording Media	Internal Memory: No	
	microSD / microSDHC / microSDXC Card (Up to 256GB Support)	
Language	English	
Interface	USB 2.0 (Micro 5 pin USB) , HDMI (Type D), Stereo Microphone Input (Diameter of 2.5mm)	
Wi-Fi	Supported (802.11b/g/n)	
NFC	Supported	
BLUETOOTH	Supported (BLE4.1)	
BLUETOOTH Remote Control-D	Supported	
BLUETOOTH Remote Control-C	Supported (Option)	
Power	Rechargeable Li-ion Battery LB-080, 3.6V 1250mAh, In-Camera Charging	
Shooting Capability (Battery Performance)	Approx. 150 shots (Based on CIPA Standards) (Wi-Fi on) Approx. 80 minutes for Video (@3525x2644 /15fps) (Wi-Fi on)	
Operation Environment	Temperature: -10 ~ 40°C, Humidity: 0 ~ 90%	
Dimensions (W×H×D)	Approx.55.0×55.0×66.9 mm (without lens cover) (Based on CIPA Standards)	
Weight	Approx. 130g (only body) Approx. 156g (with battery and memory Card)	

Prompts and Warning Messages:

Message	Description	Recommended Action
	<ul style="list-style-type: none"> ■ There are too many files, which may cause a delay in powering on. ■ When pressing the  button for recording, the memory card cannot be accessed because there are too many folders/files. 	<ul style="list-style-type: none"> ■ After copying the files to your computer, choose to delete or reformat Micro SD Card.
No Card	<ul style="list-style-type: none"> ■ No memory card is detected in the camera. 	<ul style="list-style-type: none"> ■ Insert your memory card.
	<ul style="list-style-type: none"> ■ When turning on the product or pressing the  button, the product detects that the memory card is out of capacity. 	<ul style="list-style-type: none"> ■ After copying the files to your computer, choose to delete or reformat Micro SD Card.
	<ul style="list-style-type: none"> ■ The memory card still cannot be recognized after formatting. ■ An error occurs when reading the memory card. ■ An interruption has been encountered during shooting or recording so the camera cannot shoot or record any further. 	<ul style="list-style-type: none"> ■ Reformat the memory card.
	<ul style="list-style-type: none"> ■ When the writing speed is too slow, recording cannot continue. 	<ul style="list-style-type: none"> ■ Please select a Class 10 memory card or higher for optimum performance.
	<ul style="list-style-type: none"> ■ It will be displayed while the camera is being processed. 	<ul style="list-style-type: none"> ■ No action required.
	<ul style="list-style-type: none"> ■ Connecting to your computer or TV. 	<ul style="list-style-type: none"> ■ The display will disappear after a successful connection.





Message	Description	Recommended Action
	<ul style="list-style-type: none"> ■ The camera is set to "Mass Storage" device and is connecting to the computer via USB. 	<ul style="list-style-type: none"> ■ No action required.
	<ul style="list-style-type: none"> ■ The camera is set to "Webcam" and is connecting to the computer via USB. 	<ul style="list-style-type: none"> ■ No action required.
	<ul style="list-style-type: none"> ■ Connecting to a HDMI device. 	<ul style="list-style-type: none"> ■ No action required.
	<ul style="list-style-type: none"> ■ A warning for low battery before the camera will shut down automatically. ■ The firmware cannot be updated with insufficient battery power. 	<ul style="list-style-type: none"> ■ Charge or replace with a new battery.
	<ul style="list-style-type: none"> ■ Updating firmware. 	<ul style="list-style-type: none"> ■ No action required. The camera will turn off automatically after the update is complete.
	<ul style="list-style-type: none"> ■ Battery temperature is too high. The product will automatically shut down. 	<ul style="list-style-type: none"> ■ Remove the battery carefully when the product is shut down. The battery can be used again after cooling down.

Trouble Shooting:

Problem	Possible Causes	Recommended Action
Camera does not turn on	<ul style="list-style-type: none">■ The battery has been depleted.■ The battery is installed incorrectly.	<ul style="list-style-type: none">■ Charge the battery.■ Follow the charging instructions in the manual to properly install the battery.
Blurred Images	<ul style="list-style-type: none">■ There could be smudges or dirt on the camera's lenses or the lens covers.	<ul style="list-style-type: none">■ Clean carefully with a clean, lint-free, dry cloth.
Failed to Connect to Wi-Fi	<ul style="list-style-type: none">■ Wrong password entered.	<ul style="list-style-type: none">■ Re-enter the password. If you have forgotten the password after changing it from the default factory password, you can use the reset function to restore the initial factory default password: 12345678
Slow Wi-Fi Connection	<ul style="list-style-type: none">■ There are too many programs running simultaneously on your smart device.	<ul style="list-style-type: none">■ Close other unnecessary programs and APPs connecting or running on your smart device.
Micro USB Connection Failure	<ul style="list-style-type: none">■ The wrong USB connection mode has been selected.	<ul style="list-style-type: none">■ Confirm the USB connection mode in the camera menu. If there is a need to read, save videos or photos, please select "Mass Storage". If there is a need to serve as a video chat (SKYPE) camera, please select "Webcam".

Special Accessories

There are different accessory options available for the ORBIT360 4K/4KVR360 cameras. Accessory bundle packs will vary by retailer and international regions. To purchase additional optional PIXPRO accessories separately, please contact your local retailer or visit kodakpixpro.com for a complete list of available accessories.

-  Before using your camera (especially in water or rigorous activity), please pay close attention to make sure the camera is tightly secured or housed to prevent possible damage or loss of the product.
-  Please ensure that the bonding, adhesive surface is clean and free of debris or unwanted particles before using double-sided adhesive accessories. Dirt, grease or other foreign matter will reduce the effectiveness of the double-sided adhesive. The double-sided adhesive is not easily removed after adhering.
-  Please take care to properly position and orient the accessory before sticking it to the desired surface.
-  After fully assembling and mounting the optional accessories, please make sure any screw or mount is in the proper position and fully secured.

Standard Housing-C: For use with other accessories when waterproofing is not required



 In order to prevent deformation or damage of the Standard Housing accessory, please refer to the diagram to the left for your reference and do not overtighten screws.

Installation Method:

1. Hold the bottom of the locking arm and flip up to open it.



2. Open the locking arm of the standard housing and place the camera inside housing as shown in diagram below. Press the top cover of the fixed mount around camera to close it. Press the bottom of the lock as shown in diagram below until locked into place.



3. Install the housing mount on the desired accessory and use the setscrew to tighten.



4. Use the included accessories tool to fully tighten the setscrew. Be careful not to over tighten screw and risk stripping.



Accessories Tool

Flat Adhesive Mount-A: For sticking onto a skateboard or other flat objects



Curved Adhesive Mount-A: For sticking onto a helmet or other curved objects

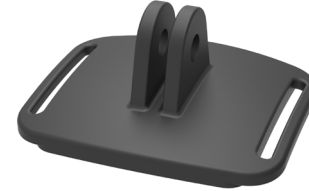

Installation Method:

There are two types of adhesive mounts: flat and curved. You should select your desired adhesive mount based on the shape of the object you intend to mount your camera to.

Both types can be installed in the same way:

1. Assemble the standard housing (📖 58).
2. Fasten the standard housing and install adhesive mounts according to the diagrams below and use the setscrew to tighten.



3. Stick the double-sided adhesive at the bottom of the adhesive mount to the object of your choice.

📄 The double-sided adhesive is disposable. It should always be replaced with a new one after being peeled off.



Double-Sided Adhesive

Bar Mount-A: For mounting on bicycle handlebars, posts, rods and other tube-like objects



Installation Method:

1. Align the bar clamp to the handlebar or tube shaped post and rotate the screws clockwise to tighten.



2. Assemble and install the standard housing (📖 58).

3. Connect and install the standard housing and bar clamp in accordance with the directions illustrated in the diagram below and use the setscrew to fully tighten.



Suction Cup Mount-A: For attachment to smooth surfaces, such as glass



Installation Method:

1. Assemble and install the standard housing ( 58).
2. Attach the standard housing to the adapter, pre-tightening the nut and suction mount in accordance with the illustration below and fully tighten the large nut.
3. Carefully clean the suction mount bottom and the smooth mounting surface before attaching the suction cup. Press the handle down to suction to your desired surface.



Vented Helmet Strap Mount-A: For mounting on objects like bicycle helmets



Installation Method:

1. Align the locator pole on the mount to the locator hole on the camera and align the screw on the mount to the camera's screw socket. Turn the screw clockwise with a coin or similar shaped object to tighten.
2. Lay out the strap before threading both ends into the helmet. Thread both ends of the band into the buckle, then press down on the buckle clamp to fasten.

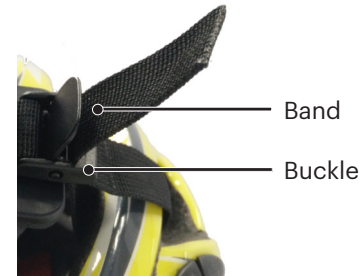
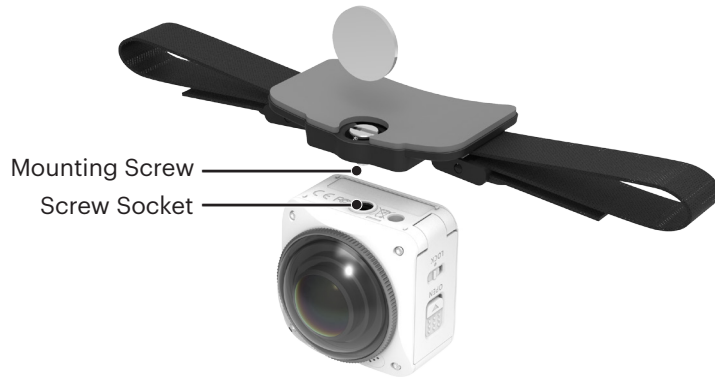

Head Strap Mount: For wearing on one's head



Installation Method:

1. Assemble the standard housing ( 58).
2. Insert the base of the standard housing to the mount before using the setscrew to fully tighten.



3. Place the band around your head and adjust to desired fit.

Selfie Stick-B and Remote Control Mount: For taking selfies or 360° shooting and recording



 Always use caution when using. Do not use the hand-held selfie stick when on a bicycle, motorized vehicle or in other unsafe scenarios.

Installation Method:

1. Assemble and install the standard housing (or the waterproof housing) ( 58/66).
2. Attach the standard housing (or the waterproof housing) to the selfie stick-B in accordance with the diagram below, then tighten the thumbscrew.

3. Twist the knob counterclockwise selfie stick sections in accordance with the directions below to extend. Twist clockwise knob to lock in place.



4. To install the remote control and clip mount to the handle, snap and lock the remote control in to the clip and attach to the selfie stick pole as shown in diagram below:



5. Attach the included wrist strap to the handle of the selfie stick. Wrap wrist strap around your wrist when in use.



Waterproof Housing-C: For use with the ORBIT360 4K/4KVR360 underwater, in wet conditions or in other circumstances where waterproofing is recommended.

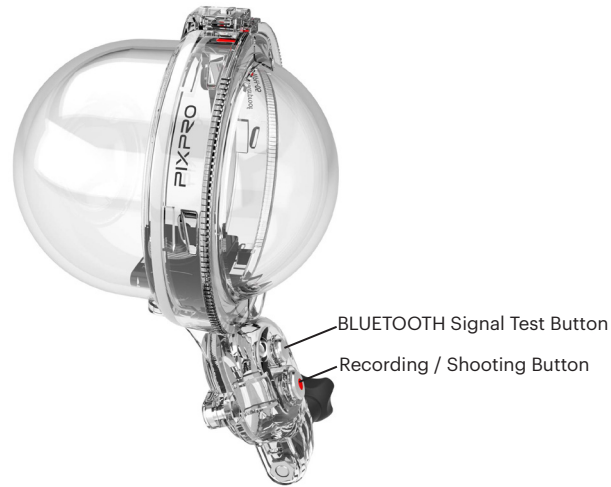

Installation Method:

1. Place the base of the Waterproof Housing near the 1/4" Screw Socket on the bottom of the camera and align the screw to the 1/4" Screw Socket then tighten screw.

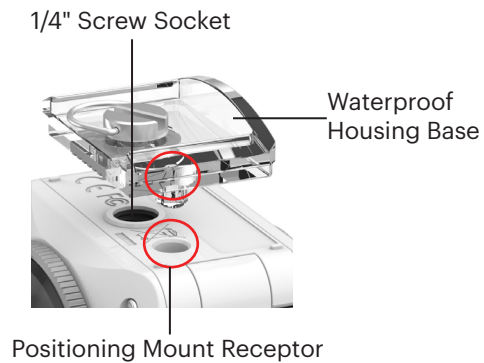

2. Remove the protective lens caps from the camera and install the Anti-Fog Insert. For more details for the installation and removal of the protective lens caps, please refer to the ORBIT360 4K/4KVR360 User Manual (📖 11).



3. Place the camera in the fixed half of the Waterproof Housing, align the red mounting marks on the front and back cover of the Waterproof Housing and turn the front cover in the arrow direction. When you hear a "click" sound, the front and back cover of the waterproof housing has fully closed and sealed.



4. Use the supplied Hex Wrench tool to loosen the Remote Control box screw on the waterproof remote enclosure. Open the cover and insert the Mini Remote Control then use the hex wrench tool to tighten the screw.



5. To install the Waterproof Housing Mount with camera enclosed on other PIXPRO accessories, use the included accessories tool to fully tighten the set screw.

 **Set the camera to  VR mode with resolution file size of 3840x2160/15M, pair the camera and the Mini Remote Control. When pairing is successful, put the camera into the Waterproof Housing.**

 **In order to prevent deformation or damage of the Waterproof Housing accessory, please refer to the diagram to the left for your reference and do not overtighten screws.**

 Before using your camera in water, please make sure you place it inside the Waterproof Housing first. It can be submerged up to 30 meters (98 feet) with the water temperature between 21°C ±10°C . The product can maintain in its waterproof performance for up to 2 hours at a depth of up to 30 meters (98 feet) while submerged.

 Anti-Fog Inserts are intended to absorb moisture. Please make sure they are dry before use (heat it in a 100°C oven for around 10 minutes). Each Anti-Fog Insert can be reused between 3-4 times.

 To open the Waterproof Housing, slide the lock in the indicated direction on the Waterproof Housing and turn the front cover counterclockwise.



 Do not open the waterproof housing when submerged in water.

Quick Clip: suitable to be clipped on a belt



Installation Method:

1. Insert the positioning poles into the camera positioning holes and screw down with a Hex Wrench.

There are three methods of quick clip installation:

- ① Place the positioning pole in the middle:



ORBIT360 4K/4KVR360 VR Mode

② Place the positioning pole on the left:



ORBIT360 4K/4KVR360
155° Front Mode

③ Place the positioning pole on the right:



ORBIT360 4K/4KVR360
235° Round (Dome) Mode



SP360 4K



SP360

2. Clip the clip onto a belt.

© 2017 JK Imaging Ltd. All Rights Reserved.

The Kodak trademark, logo and trade dress are used under license from Eastman Kodak Company.

All other logos, products or company names that are referred to in this document are trade names, trademarks or registered trademarks of their holders. The holders are not affiliated with JK Imaging Ltd., our products or our website.

JK Imaging Ltd. 17239 So. Main Street, Gardena, CA 90248 USA

JK Imaging Europe, 71 Clarendon Road, Watford, WD17 1DS, UK

kodakpixpro.com

Made in Myanmar

