



Content

1	Introduction	7
1.1	Update X1D Camera Firmware	8
1.2	X1D Features	8
	X1D Camera and Lenses Features	8
1.3	Delivery Check	9
1.4	X1D Technical Specifications	10
1.5	System Requirements	11
1.6	New in this version 1.9	11
1.7	About this User Guide	11
	Interactive PDF	11
	Search Tools	11
	Format and Printing the X1D User Guide	11
2	Safety	12
2.1	Safety and Warnings	13
2.2	Cautions	13
2.3	Disposal	14
2.4	FCC	15
2.5	ISED	15
2.6	Certification Information	15
3	Functions	16
3.1	The X1D Interaction Displays	17
3.2	Touch Display Navigation	18
	Zoom in and out on the Touch Display	19
3.3	Navigating the Menu	20
	Description of the Touch Display Menu Items	20
	Overview of Menus and Settings on Touch Display	21
3.4	Touch Display Main Menu	22
	Main Menu	22
	Add shortcuts to Main Menu Favourites	22
	How to Add shortcuts to Main Menu	23
	How to Remove shortcuts on the Main Menu	23
	Control Screen	24
	Locked Programs on the Control Screen	24
	Settings on the Control Screen	25
3.5	Parts, Components, Buttons and Controls	28
3.6	Grip Buttons and Controls	31
3.7	Camera Body Buttons and Controls	32
3.8	Mode Dial	33

3.9	Exposure Program Modes	34
	Manual Exposure Mode	35
	Manual Quick Exposure Mode	36
	Mq Mode Features	36
	Automatic Exposure Modes	37
	Custom Modes	38
	How to set a Custom Mode	38
	AE-L Button	39
	Fixed Exposure Compensation Setting	40
	Exposure Compensation / Quick Adjust	41
3.10	Light Meter Exposure Mode	42
3.11	Video Recording	43
	How To Record Video	43
	How to View Recorded Video	44
3.12	Connector Ports	45
3.13	Memory Cards	46
	Insert a Memory Card	47
	Remove SD Memory Cards	48
	Format SD Cards	49
	Format Memory Cards on the Touch Display	49
3.14	XCD Lenses	50
	Hasselblad XCD 3,5/30 mm	50
	Hasselblad XCD 3,5/45 mm	50
	Hasselblad XCD 3,2/90 mm	50
	Hasselblad XCD 3,5/120 mm Macro	50
3.15	Remove and Attach a Lens	51
	Remove the Lens	51
	Attach the Lens	52
	Remove the Lens Cap	53
	Attach the Lens Cap	53
	Remove the Lens Shade	54
	Attach the Lens Shade	54
	Filters	55
3.16	Display Information	56
3.17	Touch Display and Controls	57
3.18	Electronic Viewfinder Display EVF	58
	Typical Viewfinder Display	58
	Viewfinder Display Settings	59
	Camera Live View	60
	Live View	61
	Zooming in Live View	61
	Focus in Live View	61
	Live View with HDMI External Screen	62

3.19	Focus	63
	Focus Assist	63
	Manual Focus	64
	Manual Override in Autofocus Mode	64
	Auto / Manual Focus Setting	64
	Autofocus	65
	Single Shot Focus	66
	Focus Peaking	67
3.20	Move Autofocus Point	68
3.21	Resize Autofocus Point	69
3.22	Move Autofocus Point using Touchpad	70
3.23	Stop Down Button	71
	Stop Down / Depth-of-Field Preview	71
3.24	Change Settings on the Grip	72
	To Adjust Shutter and Aperture on Grip	73
	ISO and White Balance	74
3.25	Browsing, Preview and Histogram	75
	Browse Captures	75
	Select Card to Browse	76
	Create New Folder	77
	Standard Preview	78
	9 View Mode	78
	Histogram Types	79
	Histogram Mode	79
	Capture Details Mode	79
	How to change Histogram Overlay	79
	Luminance Histogram Mode	79
	Separate Histogram RBG Mode	79
	Histogram Exposure Mode	80
3.26	GPS Module	81
	How to mount the GPS module	81
	GPS Icon Status	82
	Technical specification for the GPS	82
3.27	Phocus Overview	83
3.28	Phocus	84
	Features in Phocus	84
3.29	Connect to a Computer	85
	Phocus and Hasselblad Capture Files	86
3.30	Battery	87
	Battery Charger	88
	Charge the Battery	88
	Rechargeable Battery Specification	89
	Battery Life and Battery Warning	90

3.31	Temperature Warning	90
3.32	Store the Camera	90

4 Settings 91

4.1	Camera Settings Menu	92
	Increment Step Size Settings	93
	Shutter Function Settings	94
	Flash Settings	96
	Flash and Strobe Settings	97
	Exposure Lock	98
	AE-L (AE-Lock) / Quick Adjust	99
	Image Format	100
	Image Orientation	101
4.2	Image Quality Settings	102
4.3	Camera AutoFocus Settings	103
4.4	Camera Manual Focus Settings	105
4.5	White Balance Tool	106
4.6	Camera Self Timer Settings	107
4.7	Camera Interval Settings	108
4.8	Camera Bracketing Settings	110
4.9	Camera Custom Buttons Settings	112
4.10	Camera Configuration Settings	113
4.11	Video Settings Menu	115
	Quality	115
	Live View	115
4.12	General Settings Menu	116
4.13	General Settings Wi-Fi	116
4.14	General Settings Display	117
4.15	General Settings Touch	119
4.16	General Settings Custom Modes	120
4.17	General Settings Storage	121
	How to format a Memory Card	121
	Image and Video Destination	122
4.18	General Settings Sound	123
4.19	General Settings Date and Time	124
4.20	General Settings Power and Timeouts	125
4.21	General Settings Spirit Level	126
	Calibrate Spirit Level	127
4.22	General Settings Language	128
4.23	General Settings Service	129
4.24	Update X1D Camera Firmware	130
	Update X1D Firmware Procedure	130
4.25	Update X1D Lens Firmware	131
	Update Lens Firmware Procedure	131

4.26	General Settings Save Log Data	132
4.27	General Settings Default Settings	133
4.28	General Settings File Counter	134
4.29	General Settings About	135
4.30	General Settings About Certification	136

5 Accessories 137

5.1	XCD Lens Range	138
	XCD 30 Lens	138
	XCD 90 Lens	138
	XCD 45 Lens	138
	XCD 120 Macro Lens	138
	XH Lens Adapter	139
	XPan Lens Adapter	139
5.2	Optional HC Lens Accessories	140
	H 13, 26 and 52 Extension Tubes	140
	Macro Converter H	140
	Converter H 1.7x	140
5.3	Optional Accessories	140
	Pro Shade V/H 60 – 95	140
	Pro Shade Adapters	140
	XCD Lens Filter Dimensions	141
	UV Sky Filters	141
	Pola Filters	141
	X1D Camera Shoulder Strap	141

6 Troubleshooting 142

6.1	Error Messages	144
6.2	Change from Unknown Language	145
6.3	Clean the Lens Glass	146
	Remove Dust	146
	Remove Smear	146
6.4	Clean the Sensor Filter	147
6.5	Information about the Hasselblad X1D User Guide	148
	3D Product Images	148
	Trademarks	148
	Copyright	148



Introduction

1.1 UPDATE X1D CAMERA FIRMWARE

The X1D Camera system can be updated with improvements and new functions.

Before you start to use your new X1D Camera, please visit www.hasselblad.com and download the latest X1D Camera firmware and update the Camera system to make sure you get the latest functionality.

See specific section in this User Guide for an in depth description on how to download the X1D Camera firmware and update your X1D Camera.

This User Guide describes the feature set of Camera Firmware 1.21.0 or later.

1.2 X1D FEATURES

Medium format advantages

Shallow depth of field.
Large sensor for unbeatable image resolution.
Super smooth colour and tone rendition.
Enlargements in breathtaking quality.

HNCS Hasselblad Natural Colour Solution

HNCS saves time and enables high Colour Quality in skin tones and specific product tones that are going to be rendered automatically and accurate.

JPEG & RAW files

The JPEG files are HNC profiled so you can print straight from a folder for amazing quality. RAW files are retained for your final masterpieces.

H.264 Video

The X1D can record HD video in H.264 format in 25 fps.

Digital Lens Correction

The Digital Lens Correction is applied at the file editing stage, takes a discerning look at any colour aberration, distortion and light fall-off however minor (which is inherent in any lens, anywhere) and resolves the situation automatically.

Hasselblad Phocus Digital Imaging Software

The Hasselblad Phocus Digital Imaging Software is a Capture Processing and File Management Application aimed primarily at Hasselblad 3F file handling. Phocus Mobile offers remote viewing and control when shooting tethered. Phocus mobile is free to download at Apple's App Store for both iPhone and iPad.



XCD 30mm



XCD 45mm



XCD 90mm



XCD 120mm Macro

X1D CAMERA AND LENSES FEATURES

Stainless steel/aluminium camera body. Access to 12 H system lenses.

XCD System lenses and accessories

XCD 30.
XCD 45.
XCD 90.
XCD 120 Macro.

XPan Lens Adapter. See page 139.

H System Lenses and Accessories

XH Lens Adapter for H system Lenses. See page 139.

Lenses

24, 28, 35, 50, 80, 100, 150, 210, 300, 120 Macro, 50-110 & 35-90 zooms. 1.7x converter & Macro Converter.

Flash

Nikon Flash Product range can be used in TTL-mode. See "Flash and Strobe Settings" on page 97 for details.

1.3 DELIVERY CHECK



Delivery Check

- 1 Unpack all items.
- 2 Verify that all the items listed on the attached package information are supplied.
- 3 Inspect all the items for damage.
- 4 If any items are missing or damaged, write down the product number of that item. If not, proceed to step 6.
- 5 Contact your Hasselblad dealer or distributor and tell them the product number of the item missing or damaged.
- 6 Keep the purchase details and the warranty in a safe place.

In the package

- USB stick with X1D User Guide and Phocus Software.
- Camera Body.
- Camera Front Protective Cover.
- Lens (if included in purchase).
- Lens Hood.
- Lens Protection lid x2.
- Battery.
- Battery Charger.
- 1 SD Card included.
- USB 3 Cable.
- Carrying Strap.



1.4 X1D TECHNICAL SPECIFICATIONS

Camera Type	Medium Format Mirrorless Digital camera with Autofocus, Auto exposure, interchangeable Lenses.
Construction	Machined aluminium. Tripod socket 1/4".
Sensor Type	CMOS, 50 mega pixels (8272 × 6200 pixels, 5.3 × 5.3 µm).
Sensor Dimensions	43.8 × 32.9 mm.
Image Size	Stills: RAW 3FR capture 106 MB on average. TIFF 8 bit: 154 MB; Video: HD (1920 x 1080p, max 5 minutes/clip).
File Format	Stills: Hasselblad 3FR. Video: H.264 Compressed (25 fps).
Shooting Mode	Single shot stills, Video. Interval Timer and Exposure Bracketing.
Colour Definition	16 bit; Dynamic range approximately 14 stops.
ISO Speed Range	ISO Auto, 100, 200, 400, 800, 1600, 3200, 6400, 12800, 25600.
Storage Options	Two SD cards or tethered to Mac or PC. SD Cards can be used in Overflow or Backup mode.
Colour Management	Hasselblad Natural Colour Solution, HNCS.
Storage Capacity	16 GB card holds 120 images on average.
Capture Rate	1.7 frames per second (2.0 in M and MQ Mode).
User Interface	Touch functionality: Yes, full support. Touch interface including swipe, scroll and pinch/spread to zoom. Camera grip with buttons and Scroll Wheels. Many camera functions and settings can be controlled from a tethered computer or iPhone/iPad over Wi-Fi.
Display	3 inch TFT type, 24 bit colour, 920 K pixels.
Live View	On camera, host and iOS device with high frame rate.
Viewfinder (EVF)	2.4 Mega-pixel Electronic Viewfinder (EVF).
Histogram Feedback	Yes, in Browse Mode on rear display and in EVF.
IR Filter	Mounted in front of sensor.
Software	Phocus for Mac and Windows. Compatible with Adobe Camera and Adobe Photoshop Lightroom.
Platform Support	Macintosh: OS X version 10.9. PC: XP/Vista/Windows 7 (32 and 64 bit)/ 8 / 10.
Host Connection Type	USB 3.0 (5 Gbit/s) Type-C connector.
Additional Connections	Mini HDMI, Audio In/Out.
Operating Temperature	-10 to 45 °C. 14 to 113 °F.
Wi-Fi	802.11 b, g, n, a, ac (a and ac depending on region).
Dimensions	Complete camera w/ XCD 45 mm lens: 148 x 97 x 125 mm [W x H x D].
Weight	1170 g (Complete camera with XCD 45 mm lens, Li-Ion battery and card).
Lenses	Hasselblad XCD lenses with built in electronically controlled shutter and aperture. Automatic or manual focusing with instant manual focus override. All HC/HCD lenses can be used with an adapter (optional). Lens shades can be mounted in reverse for transport.
Shutter	Electronically controlled lens shutter with speeds up to 1/2000. Flash sync at all speeds. Optional Electronic shutter
Shutter Speed Range	68 minutes to 1/2000 seconds with XCD lenses. 1/800 or 1/2000 with HC/HCD lenses. Electronic shutter 68 min to 1/10000.
Flash Sync Speed	Flash can be used at all shutter speeds.
Flash Control	TTL centre weighted system. Compatible with Nikon™ System flashes. ISO range 100 to 6400. Flash output can be adjusted (-3 to +3 EV) for fill-in purposes independent of ambient light. Sync at all shutter speeds.
Flash Compatibility	In TTL-mode, the following Nikon Flash products can be used: SB-300, SB-500, SB-700, SB-900, SB-910.
Focusing	Automatic and manual focusing. Instant manual focus override. Automatic focusing using contrast detection. 100% zoom possible in manual focus.
Exposure Metering	Spot, centre weighted and centre spot. Metering range. Spot: EV 2 to EV 21. Centre weighted: EV 1 to EV 21. Centre spot: EV 1 to EV 21.
Power Supply	Rechargeable Li-ion battery (7.2 VDC/3200 mAh).
GPS External Module	72-channel u-blox M8 engine supporting GPS L1C/A, SBAS L1C/A, QZSS L1C/A, GLONASS L10F and Galileo E1B/C1.

1.5 SYSTEM REQUIREMENTS

Storage and editing of images requires certain minimum computer capabilities. Large images require a reasonably high performance computer with sufficient memory, advanced graphics capabilities and a recent operating system. It is recommended that the computer has a USB 3 connector, which will allow you to load images more quickly from the camera. A USB SD card reader is also required for image transfer from the SD cards.

1.6 NEW IN THIS VERSION 1.9

- **Interval Timer**
Automatically capture images at pre-set interval. See page 108.
- **Exposure Bracketing**
Automatically capture a pre-set number of shots with different exposure between each shot. See page 110.
- **White Balance Tool**
Set White Balance by using an eyedropper tool to pick a neutral area from any captured image. See page 106.
- **Audio Notifications**
Audible signals for different events. See page 123.
- **Tethered image import**
Import images to Phocus from the memory cards of a camera connected with USB.
- **Shut-down message**
A message will be shown on the display, when the camera is shutting down.
- **Reset Settings**
This function now includes an option to exclude C1 to C3 Custom Modes. See page 133.
- **Shutter Speed Limit**
It is now possible to set the limit for Shutter Speed in Auto ISO and P modes. See page 113.
- **Custom Buttons**
Crop Mode Cycle replaced with Crop Mode Next and Crop Mode Previous. New options: White Balance Tool, Interval and Bracketing. See page 101 and page 112.
- **Browse Zoom**
Long-press on AF-D/AE-L zooms in to 100% or out to full image. For the last image, zoom is performed around the AF point that was used. See page 75.
- **EVF Browse**
Now possible to use rear display as touch pad for swiping and panning images in a zoomed-in image. See page 75.
- **EVF Live View**
While in Browse Mode on the rear display, Live View now starts immediately when activating the EVF.
- **AF support for all HC/HCD lenses** (except the HC120 Macro) when using the XH Lens Adapter. See page 139.



1.7 ABOUT THIS USER GUIDE

The X1D User Guide is designed for on-screen PDF reading to take advantage of the interactivity functions and search tools.

INTERACTIVE PDF

You can navigate the User Guide by selecting a chapter in the Table of Contents. This interactive feature is available on nearly all PDF readers, computer platforms and web browsers. All pages contain a link to the Table of Content and most page references also work as a clickable link.

SEARCH TOOLS

On most PDF readers you can use the Search Tool to find a specific subject, function or setting.

FORMAT AND PRINTING THE X1D USER GUIDE

Please note that the format is A4 to conform with the most common standard. Therefore if printing to US Letter format or similar please ensure you select “Fit to Printable Area” in the page scaling dialogue.

Photo Credits

- Page 11, 19, 56, 76, 77, 78, 81, 86, 87, 107, 110 Ian Lawson.
- Page 84 and 85, Dmitry Ageev.
- Page 84, Sails Chong.
- Page 76 Jens Karlsson.
- Page 68, 69 and 70, Damien Demolder.
- Page 115, Philip Liljenberg.



2.1 SAFETY AND WARNINGS

Warning!

Do not place cables between camera and computer so that there is a risk for people to trip and fall. This can cause personal injury and/or damage to the equipment.

Warning!

If you use spare battery packs, make sure to use protective caps on the contacts. The contacts can short circuit and catch fire, if not protected. This can cause personal injury and/or damage to the equipment.

Warning!

Do not expose batteries (battery pack and batteries installed) to excessive heat such as sunshine, fire or similar. If exposed, the batteries can catch fire. This can cause personal injury, damage to the equipment and the surrounding environment.

Warning!

Be careful when working with strobe and flash units. This will prevent personal injury and/or damage to the equipment.

Warning!

Operation of this equipment in a residential area could cause radio interference.

2.2 CAUTIONS

Caution!

Be careful when you use the camera. The camera is a precision instrument. This will help prevent damage to the camera.

Caution!

Danger of explosion if battery is incorrectly replaced. Replace only with the same or equivalent type.

Caution!

Do not use batteries other than specified. This can cause damage to the batteries.

Caution!

Use protective covers as much as possible. The protective covers will help prevent damage to the equipment.

Caution!

Use a protective case or camera bag when you transport the equipment. This will help prevent damage to the equipment.

Caution!

Protect the equipment from oil fumes, steam, humid conditions and dust. This will help prevent damage to the equipment.

Caution!

Seal all equipment in a plastic bag or similar if you enter damp and humid condition from dry and cold condition. Wait until the equipment has acclimatized to the new temperature before you remove the equipment from bag. This will help prevent damage to the equipment.

Caution!

Avoid frequent and high temperature changes. This can cause damage to the equipment.

Caution!

Keep camera and equipment away from moisture. If your camera becomes wet, disconnect from electric power and let camera dry before further use. This will help prevent damage to the equipment.

Caution!

Store the equipment in a dry environment. This will help prevent damage to the equipment.

Caution!

Be careful when you attach/detach the components to/from the camera. This will help prevent damage to the data bus connections.

Caution!

Use the grip or strap when you lift and handle to camera. This will help prevent damage to the camera.

Caution!

Do not insert fingers into the camera body. This can cause damage to the equipment.

Caution!

Do not touch the lens glass surfaces with your fingers. This can cause damage to the equipment.

Caution!

Do not touch the CMOS Sensor with your fingers. This can cause damage to the equipment.

Caution!

Keep all equipment out of reach of small children. This will prevent damage to the equipment.

Caution!

When cleaning the camera, remove the batteries. This will prevent damage to the camera.

Caution!

If you leave the camera unused for a long period, remove the batteries. This will prevent damage to the equipment.

Caution!

Do not try to remove the glass IR filter from the front of the CMOS (due to dust or similar). This can cause damage to the equipment. Always contact your local Hasselblad Authorized Service Centre.

Caution!

If you use canned compressed air to clean the glass of IR filter, read the instructions very carefully before use. This will help prevent damage to the filter.

2.3 DISPOSAL



This product must be put in municipal waste.
Check local regulations for disposal.

2.4 FCC

Federal Communication Commission Interference Statement:

This equipment has been tested and found to comply with the limits for a Class B digital device, pursuant to Part 15 of the FCC Rules. These limits are designed to provide reasonable protection against harmful interference in a residential installation.

This equipment generates, uses and can radiate radio frequency energy and, if not installed and used in accordance with the instructions, may cause harmful interference to radio communications. However, there is no guarantee that interference will not occur in a particular installation. If this equipment does cause harmful interference to radio or television reception, which can be determined by turning the equipment off and on, the user is encouraged to try to correct the interference by one of the following measures:

- Reorient or relocate the receiving antenna.
- Increase the separation between the equipment and receiver.
- Connect the equipment into an outlet on a circuit different from that to which the receiver is connected.
- Consult the dealer or an experienced radio/TV technician for help.

FCC Caution

Any changes or modifications not expressly approved by the party responsible for compliance could void the user's authority to operate this equipment.

This device complies with Part 15 of the FCC Rules. Operation is subject to the following two conditions:

- 1 This device may not cause harmful interference, and
- 2 This device must accept any interference received, including interference that may cause undesired operation.

FCC Radiation Exposure Statement:

This equipment complies with FCC radiation exposure limits set forth for an uncontrolled environment. The highest SAR value as reported to the authorities for the X1D-50c when tested for use by the Body is 0.10 W/kg and Extremity is 0.33W/kg against a limit of 1.6W/kg.

2.5 ISED

RSS-Gen Information for the Certification of Radio Apparatus
This device complies with ISED licence-exempt RSS standard(s).
Operation is subject to the following two conditions:

- 1 This device may not cause interference, and
- 2 This device must accept any interference, including interference that may cause undesired operation of the device.

Cet appareil est conforme au(x) standard(s) RSS exempt(s) de licence de ISED. Son fonctionnement est sujet aux deux conditions suivantes:

- 1 cet appareil ne doit pas occasionner d'interférence
- 2 cet appareil doit supporter toutes les interférences, y compris celles qui pourraient provoquer un mauvais fonctionnement de cet appareil.

RSS-102 RF Exposure Compliance of Radiocommunication

Apparatus

The X1D-50c has been designed to comply with safety requirements for exposure to radio waves. SAR testing has been performed in accordance with RSS-102, with the X1D-50c transmitting at its highest certified power level in all used frequency bands. The highest Body SAR value for the X1D-50c when tested was 0.10 W/kg against a limit of 1.6 W/kg. Extremity SAR was measured to 0.33 W/kg.

Please follow the instructions included in the user guide for product installation and use.

Le X1D-50c a été conçu pour se conformer aux exigences de sécurité en matière d'exposition aux ondes radio. Des tests SAR ont été effectués conformément à la RSS-102 avec le X1D-50c transmettant à son plus haut niveau de puissance certifié dans toutes les bandes de fréquences utilisées.

La valeur SAR la plus élevée pour la X1D-50c lors des tests était de 0,10 W/Kg contre une limite de 1.6 W/kg. On a mesuré l'extrémité SAR à 0,33 W/kg.

Merci de suivre les instructions fournies dans le mode d'emploi pour l'installation et l'utilisation du produit.

2.6 CERTIFICATION INFORMATION

Depending on region certification information in addition to what is engraved on the camera bottom can be found on an e-label. From the Main Menu this label is reached by pressing General Settings > About > Certification.



3.1 THE X1D INTERACTION DISPLAYS



Electronic Viewfinder Display, EVF

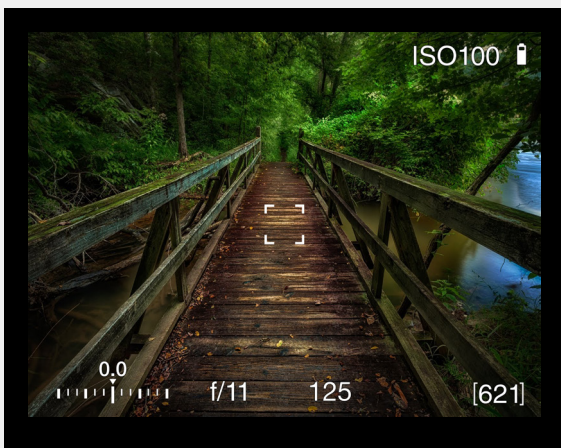

Electronic Viewfinder Display, EVF

The EVF on the Camera displays ISO, Focus action, Exposure compensation, Aperture, Shutter and Captures remaining. Press the MF/AF and the ISO/WB buttons to change settings. Use the Front Scroll Wheel or the Rear Scroll Wheel to select desired settings. Press the same button again to Exit and Save.

Touch Display

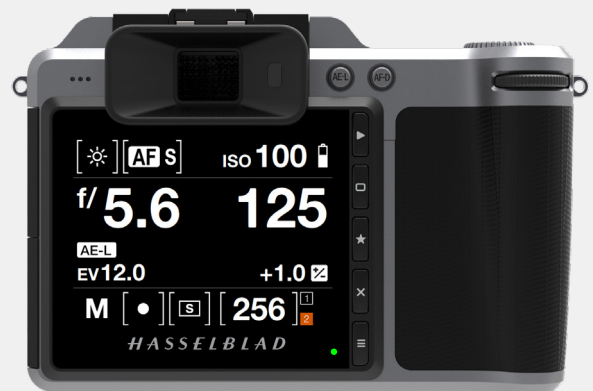

Touch Display

The X1D display is touch sensitive and you can use it in the same way you navigate on a smartphone. For example Swipe, Select, Pinch and Spread to Zoom. You can also navigate by using the 5 soft buttons to the right of the Touch Display and Scroll Wheels on the Camera.

3.2 TOUCH DISPLAY NAVIGATION

The Touch Display on the X1D Camera is similar to a Phone or Tablet with touch sensitivity. The following gestures can be used to navigate and control the camera:

Action	Function
Swipe Right	Move back / Move image right.
Swipe Left	Move image left. Only in Browse mode.
Swipe Down	Display Control Screen.
Swipe Up	Hide Control Screen.
Tap / Press	Select action / button / setting.
Double Tap	Zoom in to 100%. Double Tap again to Zoom out to full View.



Function	Action
Select	Tap / Press with one finger.
Display Control Screen	Swipe down from the top of the screen.
Hide Control Screen	Swipe up.
Move back	Swipe right.
Zoom in	Spread (move two fingers apart).
Zoom out	Pinch (move two fingers together).

Swipe Right

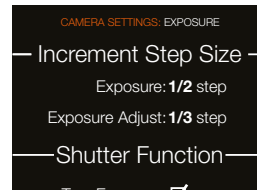

Swipe Left

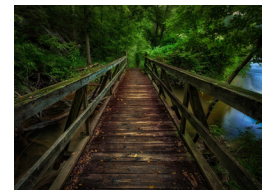

Swipe Down

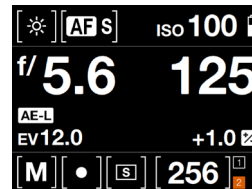

Swipe Up

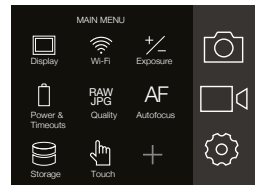
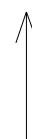

Display Control Screen from Main Menu

- 1 Swipe down over Main Menu to display the Control Screen.
- 2 The Control Screen displays the Camera Settings.
- 3 Select any of the settings to make a quick adjustment within the Control Screen Interface.
- 4 Swipe Up to hide the Control Screen and display the Main Menu.

1 Swipe Down

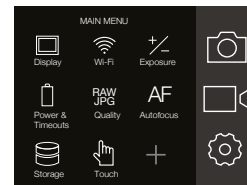

Main Menu

2

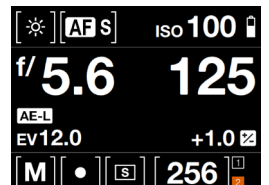

Control Screen

3 Adjust settings

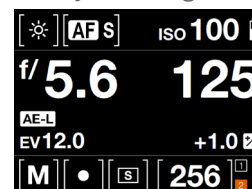

Control Screen

4 Swipe up

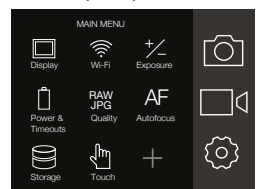
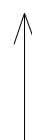

Main Menu

Note!

The Control Screen is interactive and you can change most settings. Settings that can be changed, depends on the active Shooting Mode.

ZOOM IN AND OUT ON THE TOUCH DISPLAY

The following gestures can be used to Zoom in and out on the Touch Display:

Function

Zoom in
Zoom out

Action

Spread (move two fingers apart).
Pinch (move two fingers together).

Action

Double Tap

Function

Zoom in to 100%. Double Tap again to Zoom out to full View.

Zoomed View



Standard Preview



9 View Mode

9 View Mode displays an overview of up to 9 captures. Scroll down to display all Captures in the Folder.

Enter 9 View Mode by pressing the AE-L button, or zoom out with a two finger “pinch”.

9 View Mode



3.3 NAVIGATING THE MENUS

DESCRIPTION OF THE TOUCH DISPLAY MENU ITEMS

The X1D Display Screen is Touch Sensitive. You can tap with one finger to select and swipe in different directions to move up, down, forward and backward through the user interface.

Button	Screen function
1 Browse Button	Go to image browse
2 Rectangle Button	Up
3 Star Button	Select
4 Cross Button	Down
5 Menu / (EXIT) Button	Back to Main Menu

1 Browse Button

Activates the display and shows the last image. The user can review images, browse and zoom. Preview images and zoom in to view close-ups of previews for focus checking. Zoom out to view several at once and finally to view and select folders and media.

2 Rectangle Button

Function depends on screen information. The button changes the overlay in Live View Mode. The button moves the selector up when scrolling in menus. When the Control Screen is active, the button selects parameter that can be changed with the Scroll Wheels.

3 Star Button

The Star Button zooms out to 9-view when pressed in Browse Mode.

4 Cross Button

Function depends on screen information. The button acts as Delete Image button in Browse Mode. The button moves the selector down in menus. In Control Screen it selects parameter that can be changed with the Scroll Wheels.

5 MENU / (EXIT) Button

This button opens the Main Menu. If the Main Menu is already active, the Control Screen is shown. It is also used for other tasks (for example EXIT button) as you issue commands navigating the menu system.

Using the buttons on the control panel and the scroll wheels on the grip, you can navigate through the various levels in the menu. Here is an overview of the setting options available.

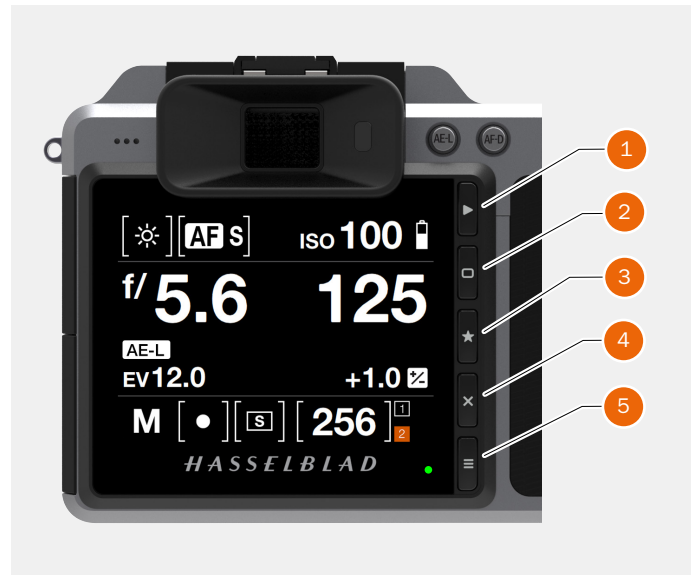

Control Screen

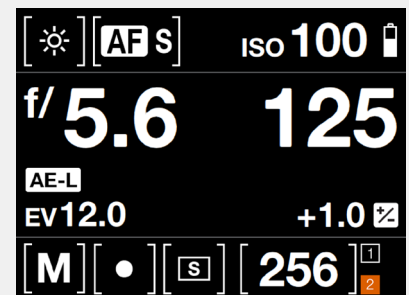

Main Menu

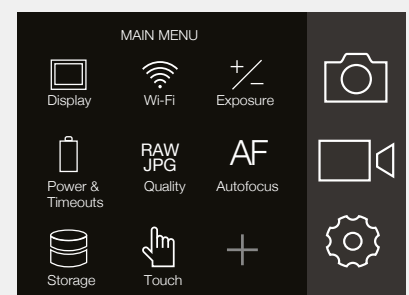

OVERVIEW OF MENUS AND SETTINGS ON TOUCH DISPLAY

The Touch Display can be controlled directly on the touch sensitive screen by pressing the menus and icons. You can scroll up, down and from left to right as described in previous chapters. You can also navigate the on screen menus by using the following buttons and scroll wheels:

- 1 Control buttons next to the Touch Display for example Menu / Exit button.
- 2 Front Scroll Wheel.
- 3 Shutter Release.
- 4 Mode Dial.
- 5 Rear Scroll Wheel.

The Main Menu on the Touch Display

On the right side of the Display there are three Main Function Settings: Camera Settings, Video Settings and General Settings. To the left of them, the Favourite Settings Short Cuts are displayed. You can add or delete these Short Cuts to access your most used functions directly from the Main Menu.

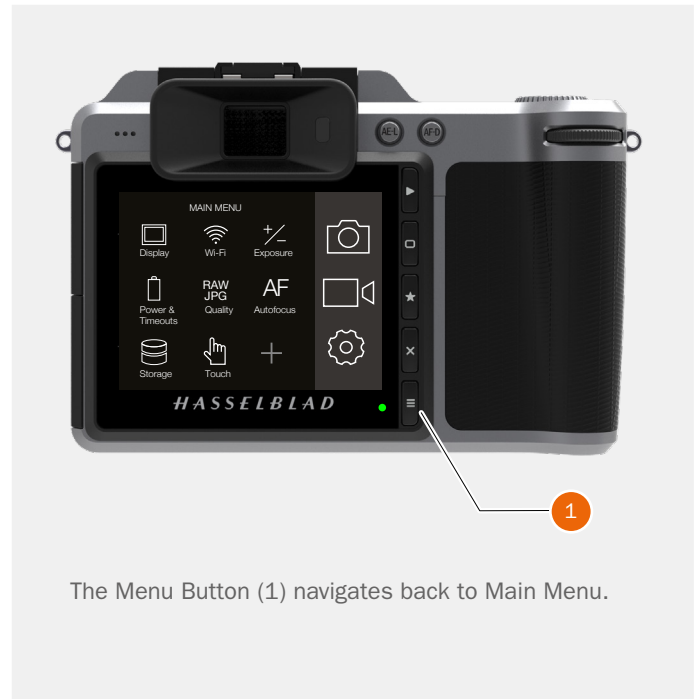

The Menu Button (1) navigates back to Main Menu.



3.4 TOUCH DISPLAY MAIN MENU

MAIN MENU

In the Main Menu there are 3 different Main Settings. Camera Settings (1), Video Settings (2) and General Settings (3). The placement of these 3 Settings are fixed and cannot be changed.

The icons on the left part of the Main Menu are Favourite Shortcuts to Functions. In this example, they are:

- Display.
- Wi-Fi.
- Exposure (+/-).
- Power & Timeouts.
- Quality (RAW/JPG).
- Autofocus.
- Storage.
- Service.

ADD SHORTCUTS TO MAIN MENU FAVOURITES

To create and speed up your own workflow you can add in the settings you use more frequently in the Favourite settings. These functions will then be displayed on the Main Menu until you remove them and replace them with other Favourite settings. To add or remove a shortcut, see the instructions on the following page.

The available functions to add are:

- | | |
|--------------------|------------------|
| Exposure | Wi-Fi |
| Image | Display |
| Quality | Touch |
| Autofocus | Custom Modes |
| Manual Focus | Storage |
| White Balance Tool | Sound |
| Self Timer | Date & Time |
| Interval | Power & Timeouts |
| Bracketing | Spirit Level |
| Custom Buttons | Language |
| Configuration | Service |
| Video Quality | About |
| Video Live View | |

See detailed description on how to add and remove functions to your Favourite list on the following page.

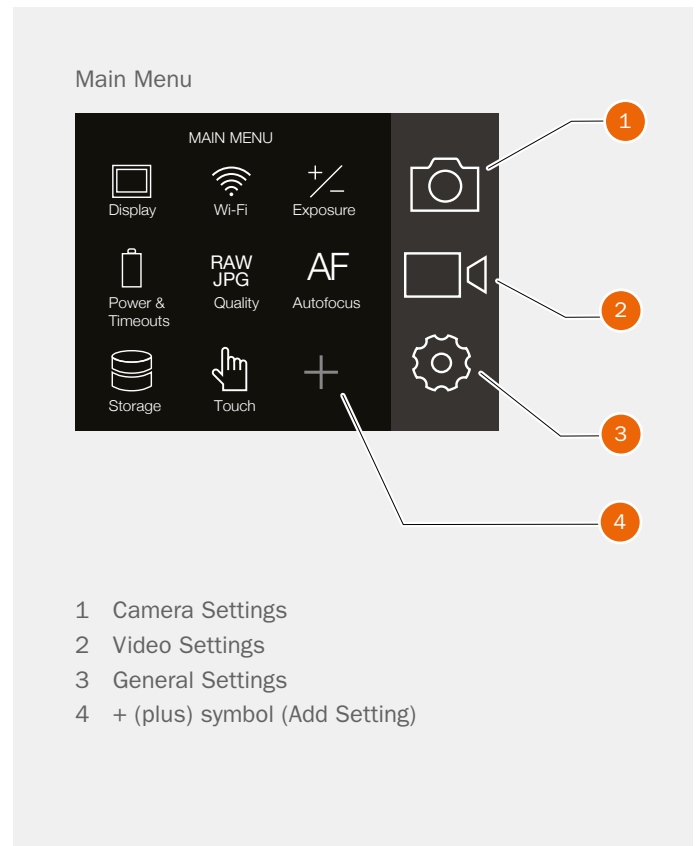

HOW TO ADD SHORTCUTS TO MAIN MENU

- 1 Select the + icon (A) on the Main Menu.
- 2 The Add Favourite Pop up screen displays the available options to add in a scroll list.
- 3 Select for example Self Timer (B).
- 4 The Self Timer icon is displayed on the Main Menu and the action is saved in the Camera Memory.

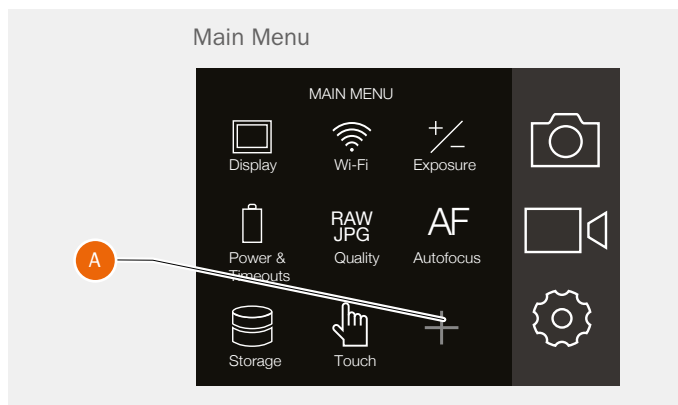

HOW TO REMOVE SHORTCUTS ON THE MAIN MENU

- 1 Press and Hold on the icon you would like to remove from the Main Menu Favourites. Self Timer (C) in this example.
- 2 The close symbol, X, is displayed on the upper right corner of the selected shortcut (D).
- 3 Select / Press the X in the orange circle to delete the icon and remove the function from the Main Menu Favourites.
- 4 The Self Timer icon is no longer displayed in the Main Menu Favourites list. You can add the same function later at any time.

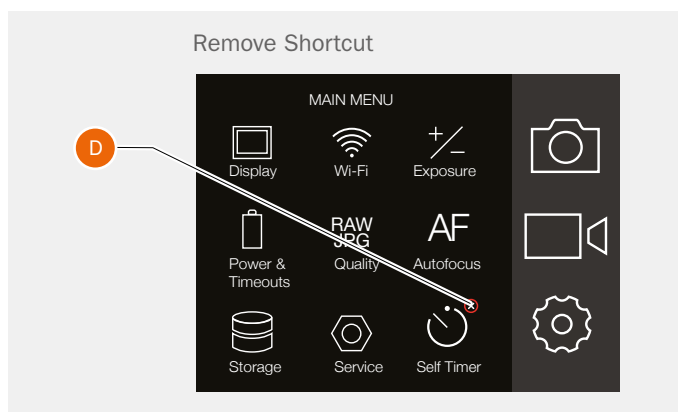
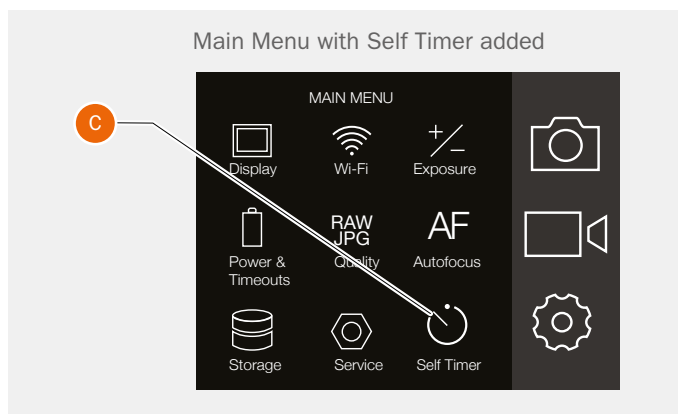
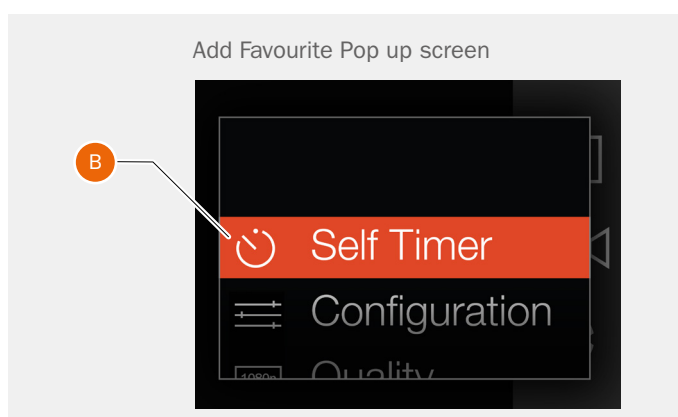

CONTROL SCREEN

You can access the most common settings using the Control Screen. You can easily change these settings by tapping on any function and adjust directly.

Display Control Screen

Swipe down from the top of the display on the Touch Display or press the soft button to the right of the display you can always display the Control Screen.

Close the Control Screen

Swipe up from the top of the display on the Touch Display or press the soft button again the display you can always display the Control Screen.

Note!

When Control Screen is displayed, there is no light metering ongoing. The sensor is inactive to save battery power.

LOCKED PROGRAMS ON THE CONTROL SCREEN

P Mode

When you select P Mode the Aperture (5.6) and Shutter (125) are automatic and displayed in grey colour that indicates that you cannot change these settings.

A Mode

For Aperture priority (A) you can change the Aperture value and the Shutter value will be automatic and displayed in grey.

S Mode

For Shutter priority (S) you can change the Shutter value and the Aperture value will be automatic and displayed in grey.

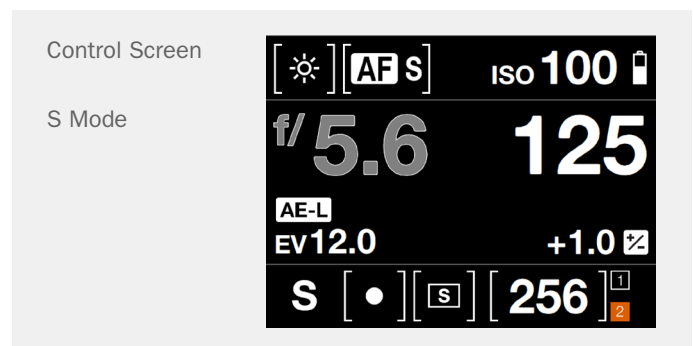
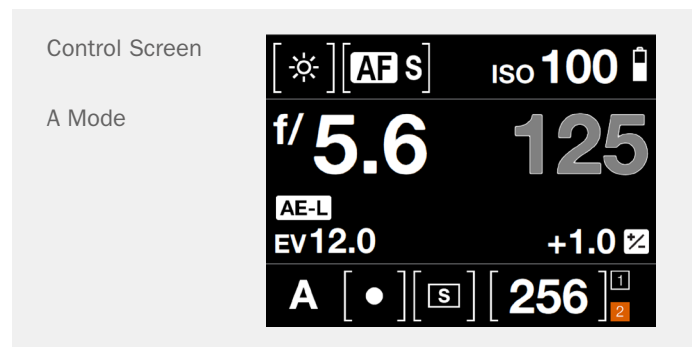
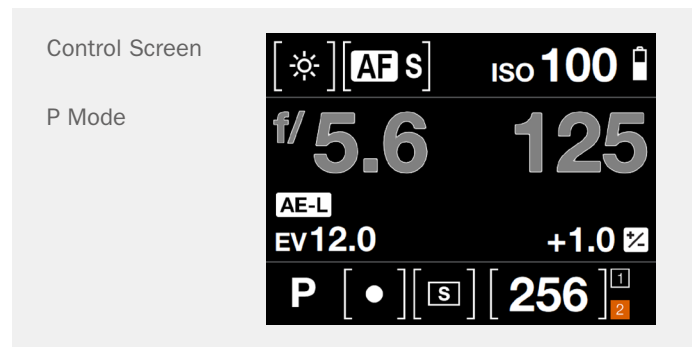
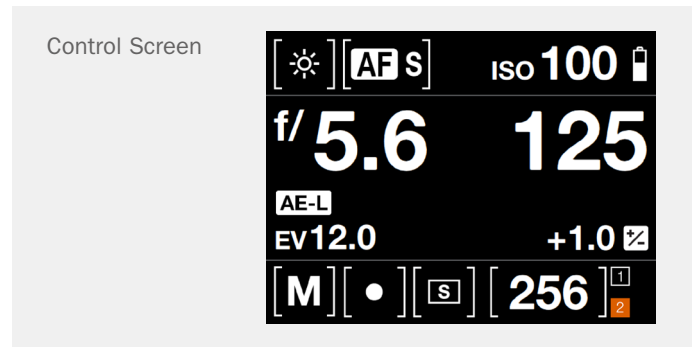

SETTINGS ON THE CONTROL SCREEN

White Balance

- Auto White Balance AWB.
- Cloudy.
- Shade.
- Daylight.
- Tungsten.
- Fluorescent.
- Flash.
- Manual WB.

	Temp [°K]	Tint
Cloudy	6500	10
Shade	7500	10
Daylight	5500	10
Tungsten	2850	0
Fluorescent	3800	21
Flash	5500	0
Manual	Variable	0

Focusing

- MF Manual Focus.
- AF-S Auto Focus Single.

ISO

- Select ISO value.

Aperture

- Select Aperture value.

Note!

You can also use the White balance Tool to set white balance from an image. See page 106.

White Balance

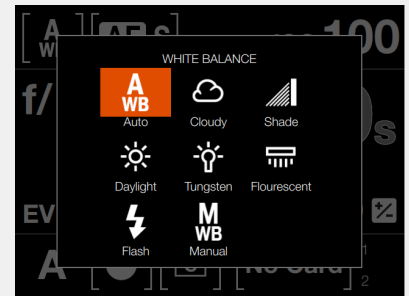

Focusing

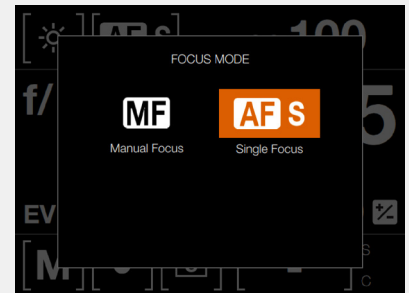

ISO

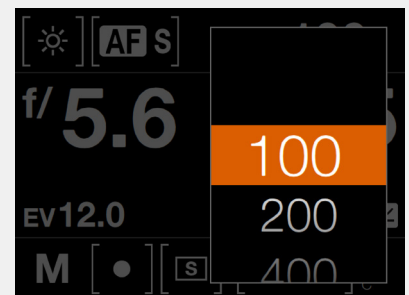

Aperture

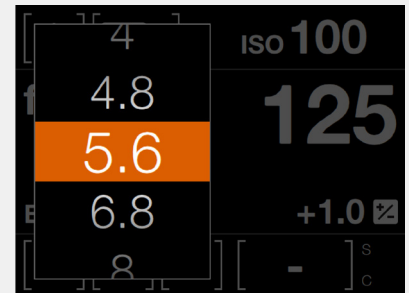

This Chapter continues on the next page.

Settings on the Control Screen

Shutter

- Select Shutter value.

Exposure Adjust

- Adjust Flash Exposure by sliding right (+) or left (-).
- Adjust Exposure by sliding right (+) or left (-).

Exposure Mode

- M Manual Mode.
- Mq Manual Quick Mode.
- A Aperture Priority Mode.
- S Shutter Priority Mode.
- P Program Mode.
- C1 Custom Program 1.
- C2 Custom Program 2.
- C3 Custom Program 3.
- Video Video Mode.
- Rectangle Automatic Mode (ISO are also automatically set).

Metering Mode

- Centre Weighted.
- Spot Weighted.
- Centre Spot Weighted.

This Chapter continues on the next page.

Shutter

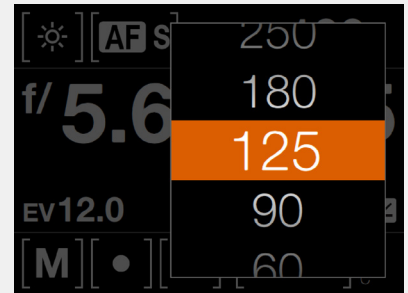

Exposure Adjust

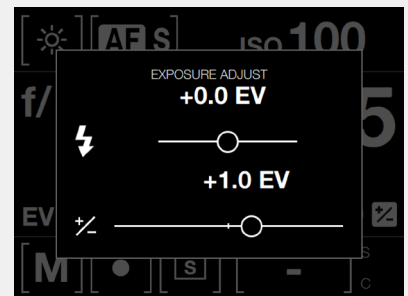

Exposure Mode



Metering Mode

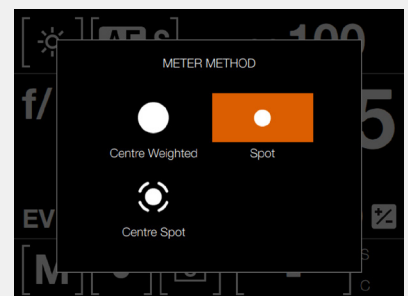

Settings on the Control Screen

Drive Mode

- Single Drive Mode.
- Continuous Drive Mode.

Note!

Continuous drive is not available with electronic shutter activated.

Remaining Captures

- Displays the number of remaining Captures.

Memory Card

- 1 for SD 1 or 2 for SD 2 Card.

Drive Mode

Single Drive Mode selected.

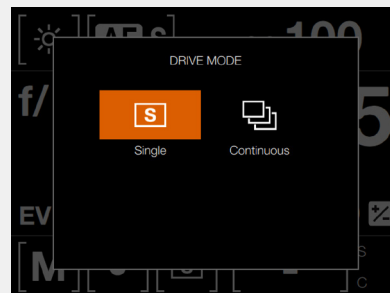

Remaining Captures

256

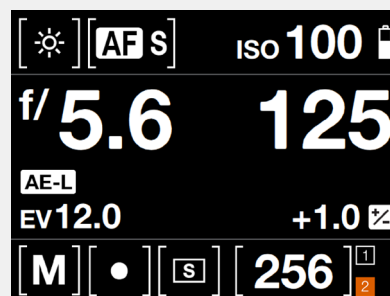

Memory Card

1 - SD 1 Card.

2 - SD 2 Card.

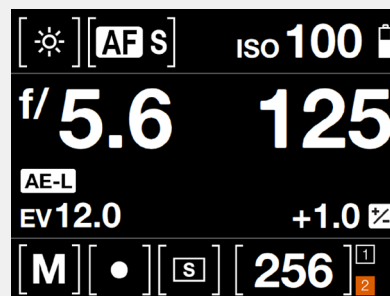

3.5 PARTS, COMPONENTS, BUTTONS AND CONTROLS

All parts listed in this Chapter, are described in detail in other specific sections.

- 1 Mode Dial
- 2 Shutter Release Button
- 3 Front Scroll Wheel
- 4 AF Illuminator LED
- 5 Camera Grip
- 6 Stop Down Button

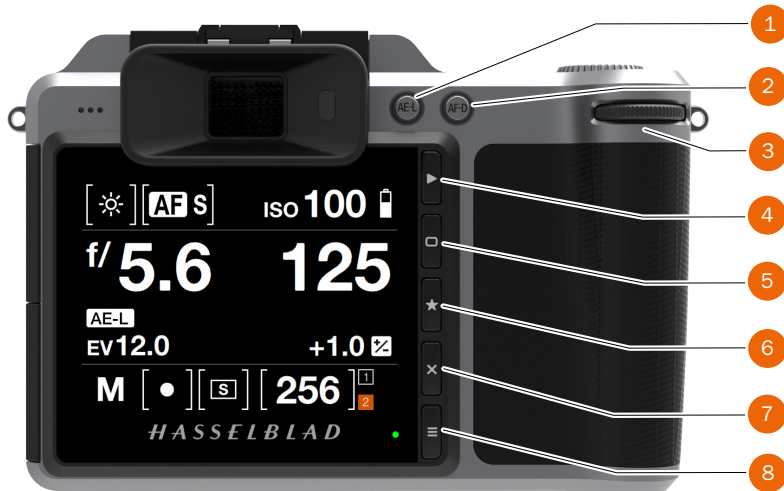

- 1 AE Lock Button
- 2 AF Drive Button
- 3 Rear Scroll Wheel
- 4 Browse Button
- 5 Soft Button
- 6 Select Button
- 7 Delete Image / Soft Button
- 8 Menu Button

- 1 Electronic Viewfinder EVF
- 2 Speaker
- 3 Strap Lug
- 4 Eye Sensor
- 5 Touch Display
- 6 Status LED







ADJUST DIOPTR

- 1 Dioptr Adjustment Wheel.
- 2 Rotate the Dioptr Adjustment Wheel to adjust to desired setting.

- 1 Tripod Thread 1/4"
- 2 Battery Release Lever
- 3 Battery



3.6 GRIP BUTTONS AND CONTROLS

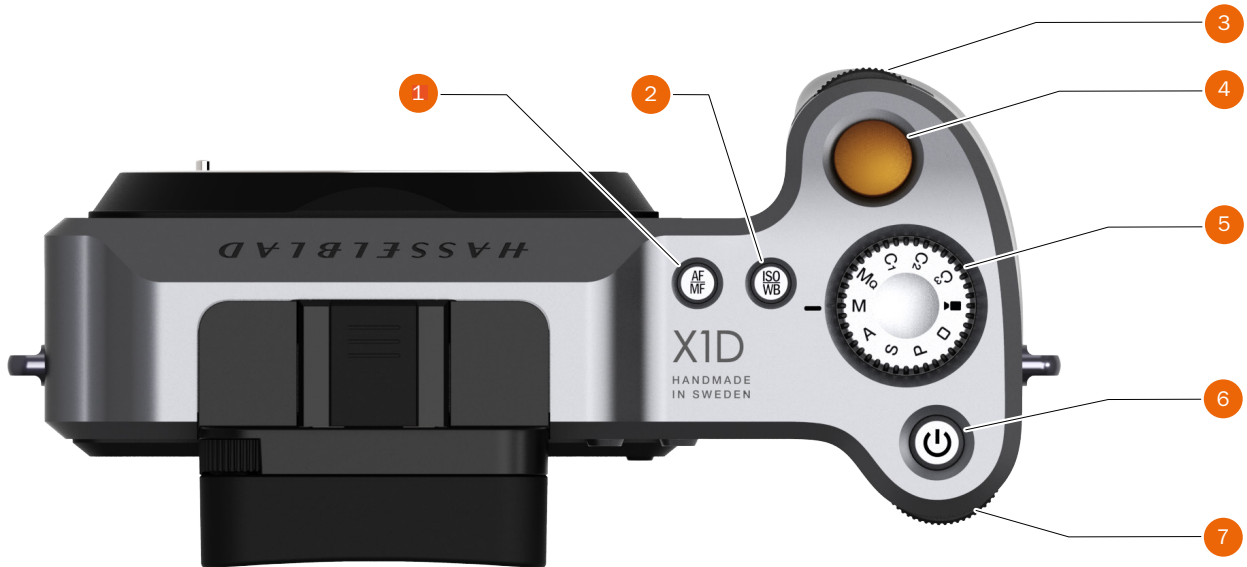

1 AF/MF button

The AF/MF button toggles between Autofocus and Manual Focus.

Can be reprogrammed as described on page 112.

2 ISO/WB button

This button provides direct access to the ISO and WB settings. Press one time to change ISO settings. Press again to change WB settings.

Can be reprogrammed as described on page 112.

3 Front Scroll Wheel

The front and Rear Scroll Wheels are used to make changes in exposure settings, navigate the Touch Display Menu as well as acting as browse controls.

4 Shutter Release Button

This button has two positions. Press half way (or soft) to activate the camera, auto focus function and exposure meter. Press all the way down (or more firm) to release the shutter. The chosen exposure procedure and the self timer are also activated with this button.

5 Mode Dial

Select any of the 10 programs. Mq, M, A, S, P, Full Automatic mode, Video mode and 3 Custom modes C3, C2 and C1.

6 ON / OFF button

Press the button for 1 second to turn on the camera. The X1D start up logo will appear and then the main screen. After a few seconds (customizable) the camera will enter Display Off mode. A long press on the button turns the camera off completely (even from Display Off mode). A short press on the button toggles Touch Display On and Off.

7 Rear Scroll Wheel

The scroll wheel is used to make changes in exposure settings, to navigate the Camera menus as well as acting as browse control.

Note!

Some of the buttons have multiple functions according to the settings made.

Note!

Some of the buttons can be reprogrammed to a different function. See page 112.

3.7 CAMERA BODY BUTTONS AND CONTROLS

1 AE-L Button

This button activates AE-L that locks a light reading made in both automatic and manual exposure modes. It also acts as a Zoom out button when browsing or as Exit button when making a setting change on the Camera, according to mode.

2 AF-D Button

The AF Drive button (AF-D) starts the Autofocus process. Press to start Autofocus and release to stop the Autofocus function. The square symbol in the centre of the Viewfinder changes colour depending on the Autofocus process.

Black - Normal mode. Autofocus is not analysing the subject.
White - Autofocus is ongoing and analysing the subject.
Green - Autofocus performed and focus is set correct.
Red - Autofocus failed to focus and is not set correct.

3 Rear Scroll Wheel

The Rear Scroll Wheel controls different settings according to the selected function.

4 Shutter Release Button

This button has two positions. Press half-way (or soft) to activate the camera, auto focus function and exposure meter. Press all the way down (or firm) to release the shutter. The chosen exposure procedure and the self timer are also activated with this button.

5 Front Scroll Wheel

The Front Scroll Wheel controls different settings according to the selected function.

6 Stop Down Button

Press to make a visual check of the depth-of-field on the viewfinder screen at the chosen aperture. The aperture will close according to the setting and remain closed as long as the pressure is maintained. You can alter the aperture at the same time to see the changes taking place.
Can be reprogrammed as described on page 112.

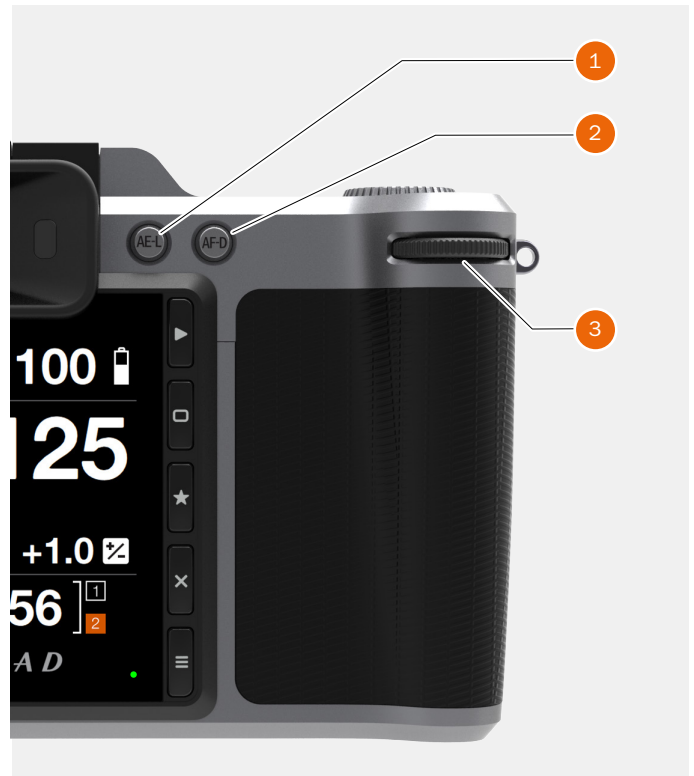

3.8 MODE DIAL

Mode Dial Selector

The Mode Dial Selector (1) displays the Camera Mode in use. There are 10 different programs selectable on the Mode Dial.

The Different Camera Modes

Mq	Manual Quick Mode.
M	Manual Mode.
A	Aperture Priority Mode.
S	Shutter Priority Mode.
P	Program Mode.
Rectangle	Automatic Mode (ISO and WB are also automatically set).
Video	Video Mode.
C3	Custom Program 3.
C2	Custom Program 2.
C1	Custom Program 1.



How to lock the Mode Dial

The Mode Dial Selector can be locked by pushing it down (2).



How to unlock the Mode Dial

When in locked mode, push once to unlock the Mode Dial Selector (3).



3.9 EXPOSURE PROGRAM MODES

There are 7 different fixed programs and 3 Custom Programs, C3, C2 and C1. The Programs can be selected by turning the Mode Dial (1) to M, A, S and P

Programs

Mq	Manual Quick Mode.
M	Manual Mode.
A	Aperture Priority Mode.
S	Shutter Priority Mode.
P	Program Mode.
Rectangle	Full Automatic Mode (ISO and WB are also automatically set).
Video	Video Mode.
C3	Custom Program 3.
C2	Custom Program 2.
C1	Custom Program 1.



In Manual Mode, Aperture is set by the Front Scroll Wheel and the Shutter Speed by the Rear Scroll Wheel.

In the Automatic Modes, the Aperture and Shutter Speed settings are controlled by the Camera, either partially or completely according to setting. Within this mode there are four choices. There are four automatic modes: A, S, P and Full Automatic Mode (Rectangle).

Exposure Modes

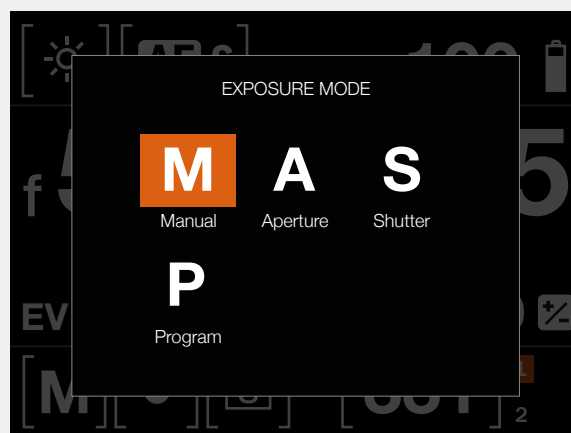

MANUAL EXPOSURE MODE

Manual mode provides total user control of the shutter and aperture settings. In this mode the aperture settings and shutter speed are manually chosen by turning the front and rear scroll wheels.

The standard exposure setting is obtained when the pointer over the exposure scale is positioned above the central index (in the viewfinder display).

Any deviation from this standard setting is displayed by:

- The pointer appearing elsewhere than above the central index
- Figures above the scale representing the amount of adjustment in EV's.

A '+ 0.7' above the scale in the display, would indicate a '0.7 EV overexposure' setting. Conversely, a '-2', for example, would indicate a '2EV underexposure' setting. Note that the appearance of a +/- symbol on the display and in the viewfinder, in manual mode, means that a change has been made to the exposure compensation setting. See later section on Exposure compensation.

The actual aperture settings and shutter speeds are indicated to the right of the exposure scale in the conventional manner.

Note!

Full-stops, half-stops and third-stops are also displayed, according to setting (see increment setting). For example, a setting between f/8 and f/11 will appear as f/9,5 if half-stop is chosen.

Exposure Modes

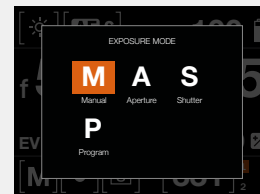

MANUAL QUICK EXPOSURE MODE

Mq mode is a Manual mode where the camera performs as fast and quiet as possible. In this mode, the Shutter is always closed and the Live View is disabled. This mode works best when the X1D Camera is used on a fixed Tripod.

- 1 First set the Focus and Image Composition in another Program mode like Manual mode (M) for example. Mq mode does not support Live View.
- 2 Use the X1D Camera on a fixed stable Tripod.
- 3 Select Mq mode on the Mode Dial.

MQ MODE FEATURES

- Mq mode saves Power because the Live View is Off.
- Mq mode is faster because the Shutter is already closed and ready for exposure.
- Mq mode is more silent due to the fact that the Camera uses less Shutter movements.

Note!

The White Balance mode "Auto", AWB, requires Live View to be active before it can set the correct White Balance. To use AWB in Mq mode (without Live View option), start Live View in (for example) M-mode before changing to Mq mode.



AUTOMATIC EXPOSURE MODES

Select Exposure Mode by turning the Mode Dial (1).

Automatic exposure provides a choice of two ways to control the shutter speed and aperture settings semi automatically and two ways fully automatically.

Aperture priority A

The aperture is manually chosen by turning the Front Scroll Wheel, and the shutter speed is automatically chosen by the camera.

Shutter priority S

The shutter speed is manually chosen by turning the Front Scroll Wheel, and the aperture is automatically chosen by the camera.

Programmed P

In this mode, an aperture/shutter combination is chosen by the camera according to the EV measured (metering method remains as your choice), though only within preset appropriate limitations to suit various requirements and applications.

Full Auto □

In this mode, an aperture and shutter combination is set by the camera. The camera is always in AF Mode and no adjustments can be made. White Balance is set to Auto, Metering Method is Centre Weighted and Drive Mode is set to Single Drive Mode.

Note!

In Automatic mode the Front Scroll Wheel selects alternative aperture/shutter combinations while maintaining the same EV and the Rear Scroll Wheel alters the amount of exposure compensation. The compensation appears as a +/- symbol on the Control Screen and Viewfinder Display.

Note!

Aperture and shutter speed settings can both be changed even while the red “busy light” on the Touch Display is flashing.

Note!

In Camera Settings, the Quick Adjust function can be set to either adjust the following exposure only (default) or on all future exposures.



CUSTOM MODES

The Custom Modes C3, C2 and C1 are three Modes that can be saved with your favourite settings.

HOW TO SET A CUSTOM MODE

- 1 Select a mode on the Mode Dial.
M, A, S or P M is selected in this case (A).
- 2 Make the changes to the Camera Settings.
Set desired ISO, AF/MF and WB for example.
- 3 Press the Menu Button to the right of the Touch Display to display the Main Menu.
- 4 Select General Settings.
- 5 Select Custom Modes.
- 6 Select Save to C1, C2 or C3.
- 7 Select Save to save and Exit or select Exit to exit without saving.
- 8 All the settings you made will now be easily accessed from the Custom Mode C1.
- 9 Turn the Mode Dial to select C1 (B).
- 10 You can now use the Camera with all the specific settings made in stage 2 of this instruction.

Repeat the step 1 to 10 to create and use your 3 different Custom Modes, C1, C2 and C3.

When the Mode Dial is set C1, C2 or C3, it is possible to change exposure mode from the control screen by tapping the Exposure Mode Icon in the lower left corner. This will bring up a screen as shown in (C) where a new exposure mode is selected by tapping the corresponding icon.

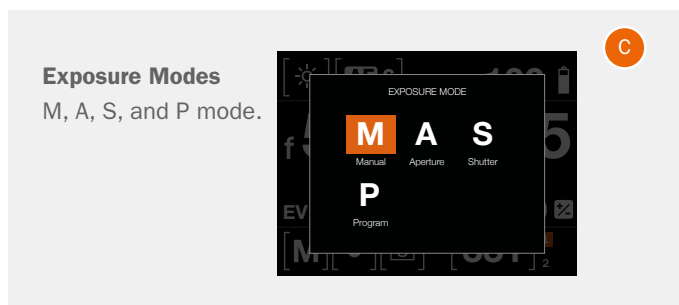

AE-L BUTTON

In Live View mode, this button is used for locking the exposure in the automatic modes (A, S P and ). In Manual mode, this button will lock the aperture and shutter speed combination, allowing you to shift aperture and shutter speed combination without changing the exposure with the scroll wheels.

In Browse mode it is used to zoom out in the image (AF-D zooms in).

In Menu mode it is used to exit one level up in the menu (AF-D enters one level down).

Lock an EV setting in manual and automatic modes

When the button is pressed, the light metering facility is locked to the EV setting at that moment. An L (=locked) symbol appears between the shutter speed and the aperture indication on the Touch Display and Electronic Viewfinder Display to confirm the status. Press the AE-L button again to unlock (a toggle function).

In the locked setting, the aperture and shutter speed become interlocked. In this way, a new aperture/shutter combination that still represents the same EV, can be rapidly chosen. For example, if the shutter is set to 1/125s and the aperture to f/8 and are locked together, you can access new EV-equivalent combinations of, for example, 1/30s at f/16 or 1/500s at f/4 just by moving the front scroll wheel.

In practice this means that you can, for example, in auto mode position the metering area (spot setting) over an area in the subject that you determine to be equivalent to a mid-grey and lock it with the AE-L button. You can then recompose the picture with the metering zone positioned over an area much brighter or darker while still retaining the original exposure setting and choose a new combination of aperture and shutter speed settings.



FIXED EXPOSURE COMPENSATION SETTING

- 1 Select the Exposure Adjust setting on the Control Screen.
- 2 Turn the Front Scroll Wheel (B) to change the Flash compensation and the Rear Scroll Wheel (C) on the grip to increase or decrease the amount of Exposure Compensation in 1/3 EV steps.
- 3 The amount is displayed as both an EV figure complete with a 'minus' or 'plus' prefix, and as a marker above a 'minus' to 'plus' scale,
- 4 Press AE-L Button (A) to reset any compensation back to zero.
- 5 The settings are saved.
- 6 A '±' symbol is then displayed between the aperture and shutter speed setting as confirmation of the setting.



EXPOSURE COMPENSATION / QUICK ADJUST

The exposure compensation function, for both manual and automatic modes can be set from -5 to +5 EV, in 1/3, 1/2 or 1 EV increments and is visible above the scale in the viewfinder and as a \pm symbol on the Touch Display Control Screen.

The quickest way to make an adjustment in auto exposure mode is to use the Rear Scroll Wheel (A).

Temporary compensation setting in an auto-exposure mode using the Quick Adjust function:

- 1 Turn the rear scroll wheel (A) to select the chosen amount of compensation.

The amount is displayed as both an EV figure complete with a 'minus' or 'plus' prefix and as a marker above a 'minus' to 'plus' scale.

Default settings provide 1/3 EV compensation and an immediate clearing of the setting after capture.

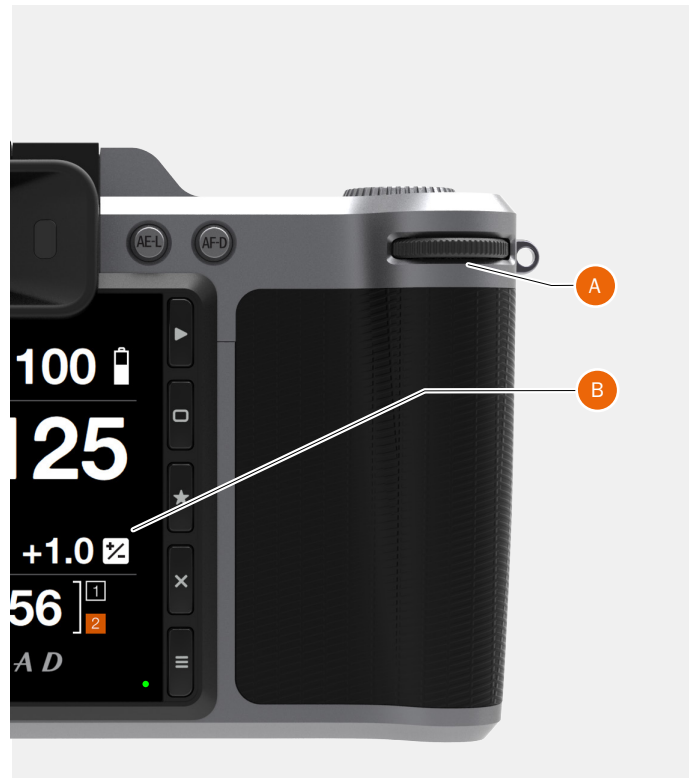

Adjust the Exposure on the Control Screen

- 1 Swipe Down on the Touch Display to access the Control Screen.
- 2 Select Exposure Adjust (B).
- 3 Adjust sliders to the left or right to change values (C).
- 4 Close the Exposure Adjust pop up by clicking outside of it.
- 5 Swipe Up to exit Control Screen and return to Main Menu.

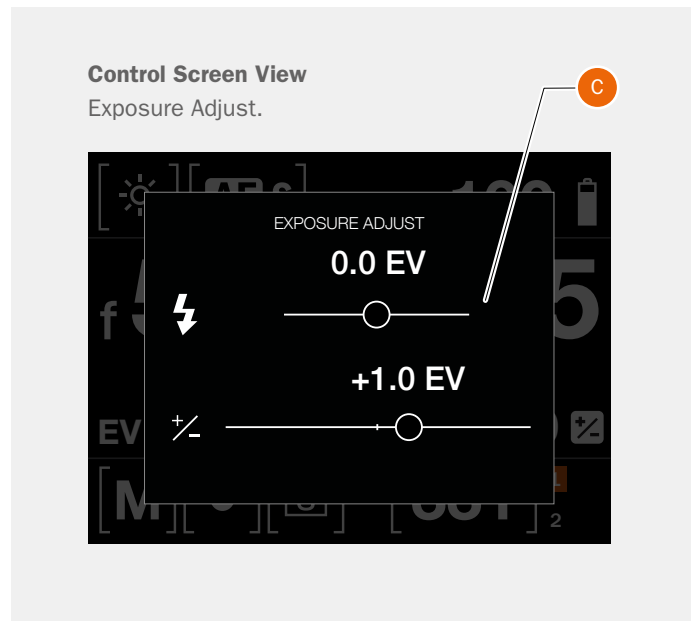

3.10 LIGHT METER EXPOSURE MODE

The Light Meter Mode can be changed on the Control Screen. Use the Rear Wheel to select Mode.

Different Light Metering Modes

There are three reflective metering modes available.

- Centre Weighted.
- Centre Spot.
- Spot Metering.

Metering Modes

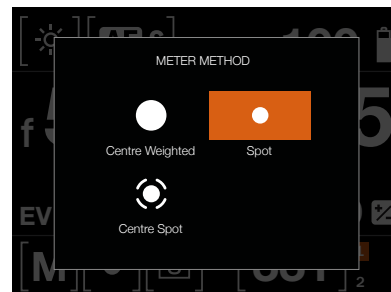

Symbol	Light Metering Modes
	<p>Centre Weighted</p> <p>Used for light situations where there is no particular dominance of light or dark areas across the tonal range. Takes into account approximately 25% of the image seen in the viewfinder.</p>
	<p>Centre Spot</p> <p>Emphasizes the central section of the focusing screen equivalent to approximately 25% of the image. This provides a balanced assessment and is a typical choice where the main subject is in the centre of the image.</p>
	<p>Spot</p> <p>The sensitive area is equivalent to approximately 2.5% of the image area (the central spot on the viewfinder screen). Any parts of the image outside of this area will not affect the exposure reading. This provides a very accurate measurement of specific tones. Also excellent for tonal comparison measurements.</p> <p>Spot area is marked in Live View screen.</p>

Live View with Spot area

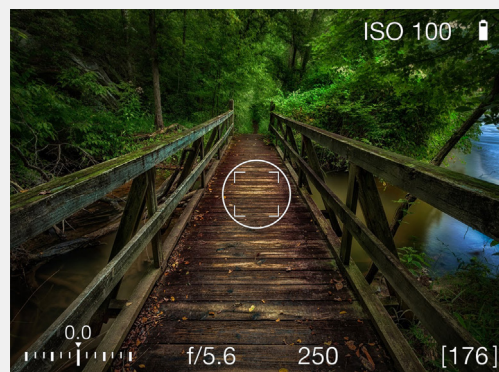

3.11 VIDEO RECORDING

HOW TO RECORD VIDEO

First select Video Settings in the Video Settings Menu.

- 1 Select Video mode on the Mode Dial (B).
- 2 The Video Control Screen is displayed on the Touch Display.
- 3 Start the Video Live View by pressing the Live View Video icon (C).
- 4 The Video is displayed on the Touch Display.
- 5 Start Recording by pressing the Shutter Release Button (A) or by pressing the red recording icon on the Touch Display. The recording icon is grey during recording.
- 6 Stop the Recording by pressing the Shutter Release Button (A) or by pressing the grey stop icon on the Touch Display.



Note!

For best Video result, use a stable tripod with the X1D Camera when recording Video.

Note!

The maximum length of one video clip is 5 minutes. The number of video clips possible to save, depends on the capacity of the inserted SD memory card.

Note!

You can change ISO and White Balance from both Video Control Screen and Video Live View screen by tapping the values.

Video Control Screen

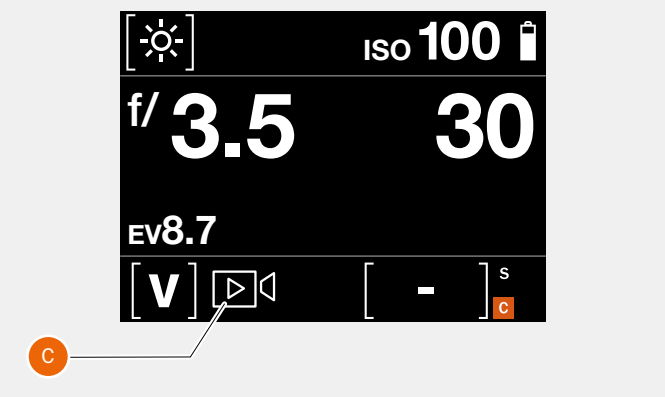

Video Live View Screen

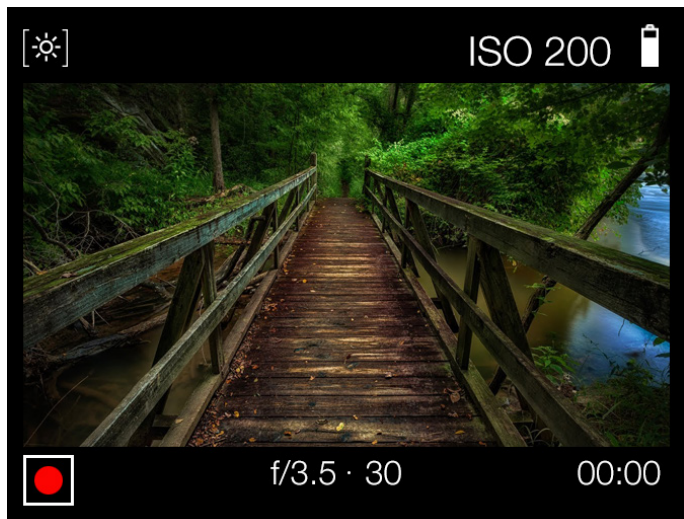

Video Display when capturing video

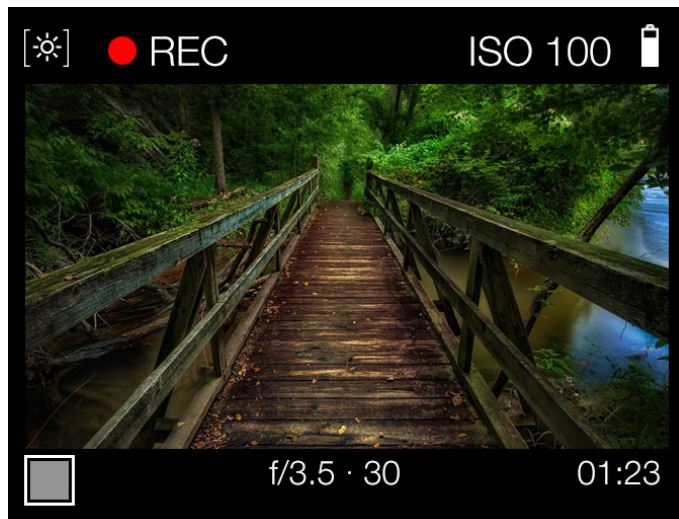



HOW TO VIEW RECORDED VIDEO

- 1 Press the Browse button (A).
- 2 The recorded videos are displayed with a Poster Frame (preview image) and a Play icon.
- 3 Select video to view.
- 4 Press the Play icon on the Touch Display (white triangle) to view the selected Video.
- 5 Press the button (B) to stop video playback.

Note!

Videos can be previewed on the rear screen or in the EVF, depending on which is active when the Browse button (A) is pressed. Video playback in the EVF can only be started by pressing the Browse button again.



Captured Video Display

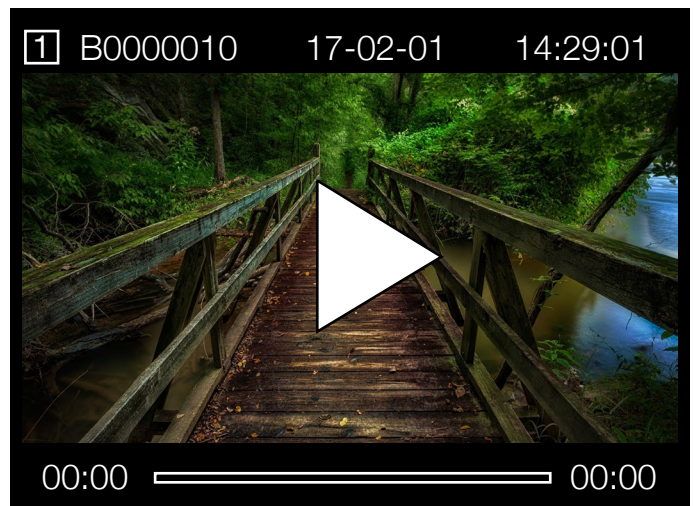

3.12 CONNECTOR PORTS

1 SD Card Port 1

Port for the SD Card no 1.

2 SD Card Port 2

Port for the SD Card no 2.

3 HDMI

Connector for Mini HDMI plug.

4 Audio in

Connector for Audio In Microphone 3.5 mm stereo plug.

5 USB 3 Tethering plug

Connector for USB 3 plug.

6 Audio Out

Connector for external 3.5 mm Stereo Audio Out Plug.



3.13 MEMORY CARDS

The X1D camera uses SD cards only. There are two SD Card slots on the X1D Camera, slot no 1 and slot no 2.

When using a SD card, the X1D is completely self contained. No additional wires or connectors need to be attached.

The recommended minimum write speed is 60 MB/sec (400x) or better.

Note!

All cards must be formatted in the X1D camera before first use.

SD Memory Card Status Display

- 1 Black = Not inserted, not active (3).
- 2 Orange = Inserted, Active (4).
- 1 or 2 [0] = Full.
- 1 or 2 ! = Card Error.
- Lock Symbol = Card Write Protected.

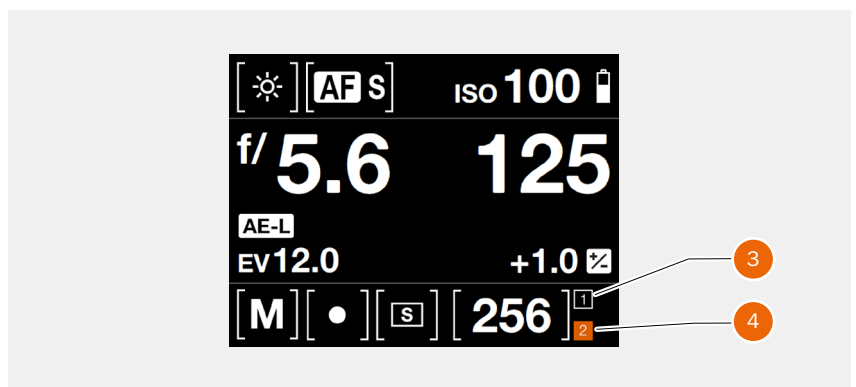

Currently Approved Cards

UHS-I cards:

SDHC-I SanDisk Extreme PRO 95MB/s
Wise SDXC-UHS-I U3

UHS-II cards:

SDXC UHS-II Lexar Professional 2000x
SDHC UHS-II SanDisk Extreme PRO 300MB/s
(UHS-II cards can only achieve UHS-I speed, 80 MB/s)
Delkin SD1900X

INSERT A MEMORY CARD

Insert SD card

- 1 Open the Memory Card Slot Cover by sliding it towards the back of the Camera and then rotate it clockwise.
- 2 When the card slot cover door is opened, mount the SD card in the SD card slot no 1 (A) or no 2 (B).
- 3 Close the slot cover by rotating it counter clockwise and pushing it in place towards the front of the camera (C) to lock it into position.

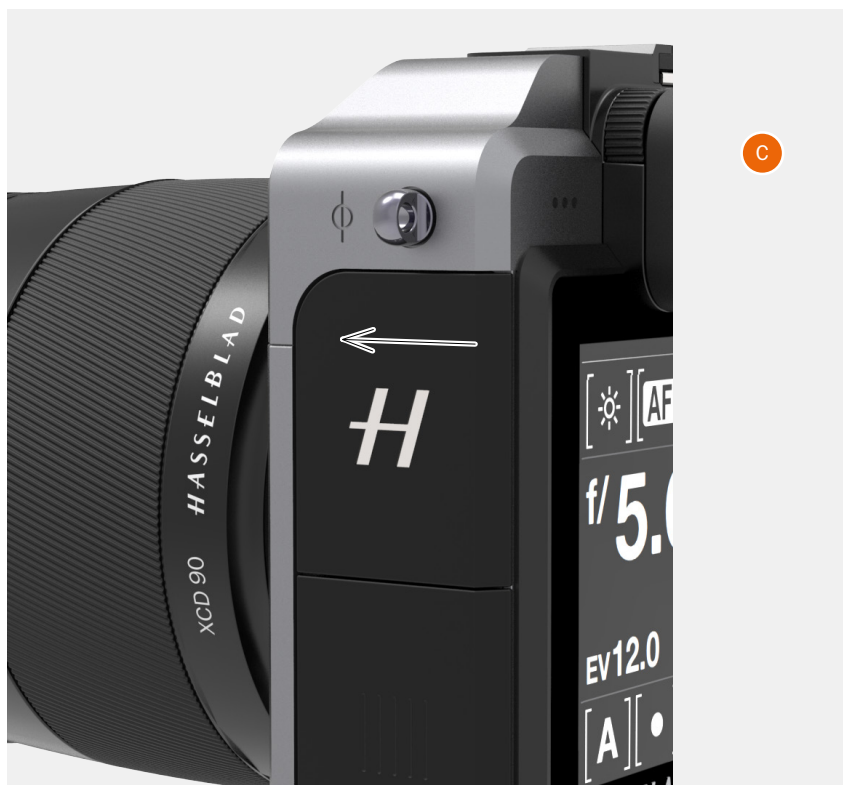

REMOVE SD MEMORY CARDS

Note!

Do not remove a memory card from the Camera if the 'ready' light is blinking (placed in the lower right corner on the Touch Display), as this will corrupt the files on the card and result in data loss. The card will also need to be reformatted.

Remove SD card

- 1 Open the memory card slot cover on the Camera (A).
- 2 Press the SD card no 1 (B) or no 2 (C) a little way in and then release it. The SD card will then move out from the SD card slot.
- 3 Grab the card and pull it away from the Camera.
- 4 Close the slot cover (D) by rotating it counter clockwise and pushing it in place towards the front of the camera to lock it into position.

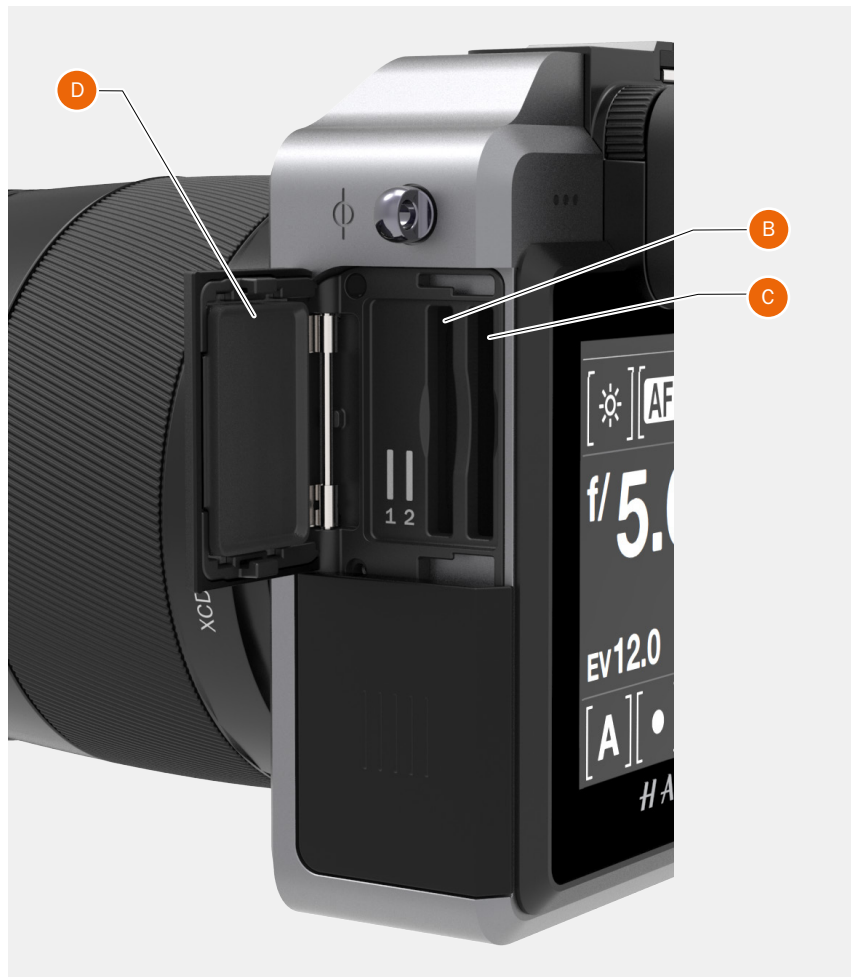

FORMAT SD CARDS

MAIN MENU > GENERAL SETTINGS > STORAGE > FORMAT

The camera is only able to read and write to storage media that have been formatted correctly. New cards sometimes have no formatting, or you might want to convert a card that is currently using a format that the camera cannot read. In either case, you must reformat both SD cards within the X1D Camera to be able to use the SD Cards.

FORMAT MEMORY CARDS ON THE TOUCH DISPLAY

MAIN MENU > GENERAL SETTINGS > STORAGE > FORMAT

- 1 Press MENU.
- 2 Navigate to Storage.
- 3 Navigate to Format.
- 4 Navigate to Format SD card.
- 5 Select "Format SD 1" or "Format SD 2".
- 6 A Format Card Dialogue appears.
- 7 To confirm, select Format by pressing the Soft button marked with a square (A). To exit without formatting, press the Soft button marked with "X" (B).

Note!

The X1D Camera is capable of writing up to 80 MB/s to SD cards.

Note!

All SD Memory Cards should be formatted in the X1D Camera before using them the first time.

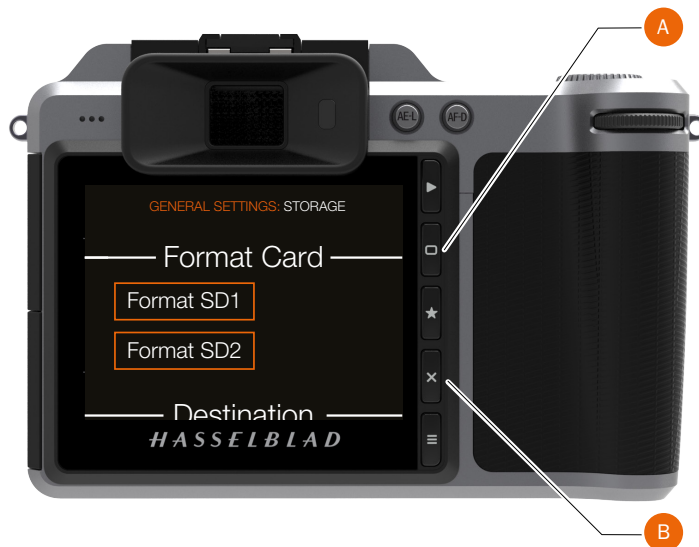

Storage Menu

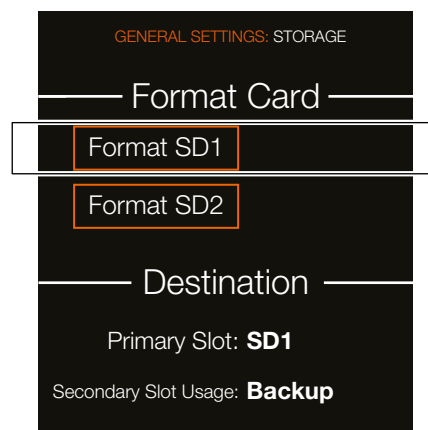

Format Card Dialogue Display

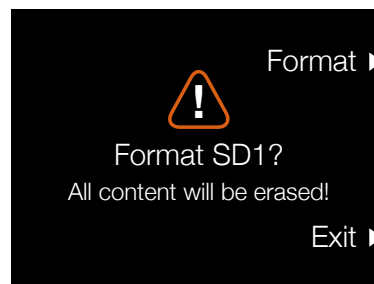

3.14 XCD LENSES

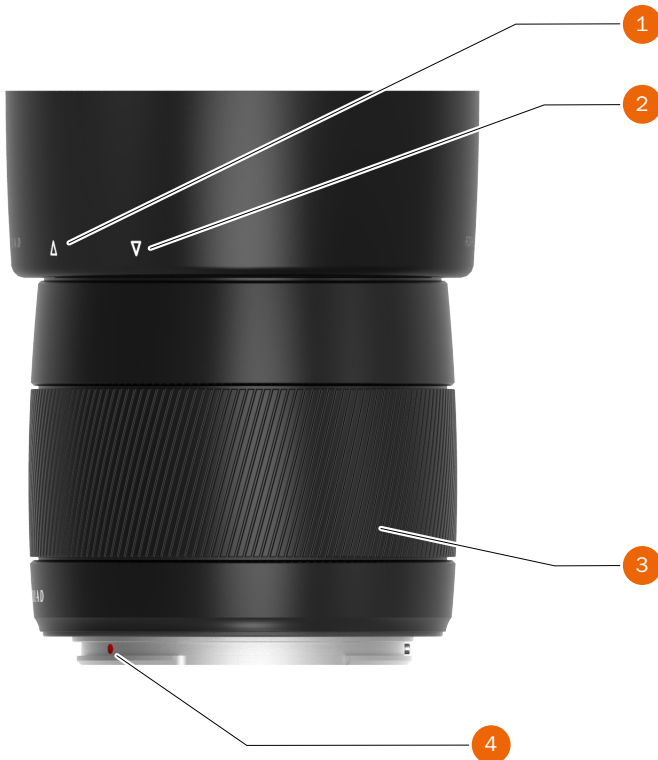

- 1 Lens shade index for reverse mount**
- 2 Lens shade index**
- 3 Focusing ring**
- 4 Lens index**



HASSELBLAD XCD 3,2/90 MM

The XCD 90 mm lens is the ideal portrait lens for the X1D. Its moderate telephoto focal length provides a 71 mm equivalent field of view, making it the perfect portrait lens.

Coupled with its wide aperture, the focal length allows you to isolate small elements in the field of view with a beautiful smooth bokeh.



HASSELBLAD XCD 3,5/30 MM

The XCD 30 mm lens is the widest angle lens for the X1D. Its focal length provides a 24 mm equivalent field of view, making it the perfect landscape, reportage and travel lens.

The lens boasts extremely high performance and a compact build, providing a 71° horizontal angle of view. A unique feature is that the lens will keep its amazing performance even when shooting at close distance.



HASSELBLAD XCD 3,5/45 MM

The XCD 45 mm lens is the ideal standard lens for the X1D. Its moderate wide angle focal length provides a 35 mm equivalent field of view, making it the perfect general purpose and travel lens.

As part of the X System lens range, its lightweight and compact size perfectly complements the compact X1D body.



HASSELBLAD XCD 3,5/120 MM MACRO

The XCD 120 mm Macro is a compact macro lens for the X1D camera featuring close focusing from infinity to an image scale of 1:2.

The optical design and internal focusing system ensures amazing performance at all distance settings.

You can download technical data sheets from the Hasselblad website, www.hasselblad.com.

3.15 REMOVE AND ATTACH A LENS

REMOVE THE LENS

Caution!

Be careful when you attach/remove the components to/from the camera. This will help prevent damage to the data bus connections.

Caution!

Do not insert fingers into the camera body. This can cause damage to the equipment.

- 1 Hold the lens (C) with one hand and hold the camera body (A) still.
- 2 Push the lens removal button (B).
- 3 Rotate the lens counter clockwise.
- 4 Push the lens (C) away from the camera body.
- 5 Attach the protection cover lid (D) on the camera body directly.
- 6 Attach a lens protection lid on the detached lens to prevent damage.
- 7 Store the lens with both lens protection lids on and the lens hood inverted over the lens instead of in front of the lens.



ATTACH THE LENS

Caution!

Be careful when you attach/detach the components to/from the camera. This will help prevent damage to the data bus connections.

Caution!

Do not insert fingers into the camera body. This can cause damage to the equipment.

- 1 Push the lens removal button (A) and remove protection cover lid (B) from the camera body.
- 2 Rotate the lens so that the red mark on the lens (C) lines up with the red mark (D) on the camera body.
- 3 Mount the lens (E) into the camera body (F) and then turn the lens clockwise to lock its position.
- 4 Make sure the lens is locked to the camera body before using or moving the camera.



REMOVE THE LENS CAP

- 1 Insert thumb and index finger into the recesses (A).
- 2 Pinch the recesses (A) together.
- 3 Remove the front lens cap.

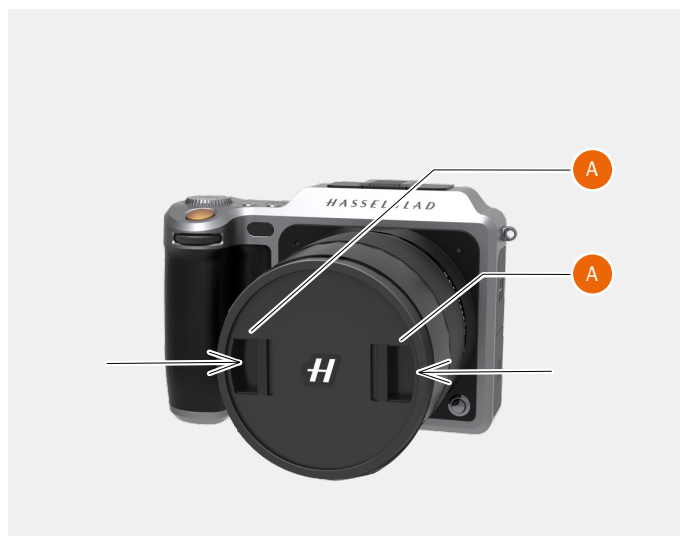

ATTACH THE LENS CAP

- 1 Insert thumb and index finger into the recesses (A).
- 2 Pinch the recesses (A) together.
- 3 Attach the front lens cap on the lens until it snaps into place.

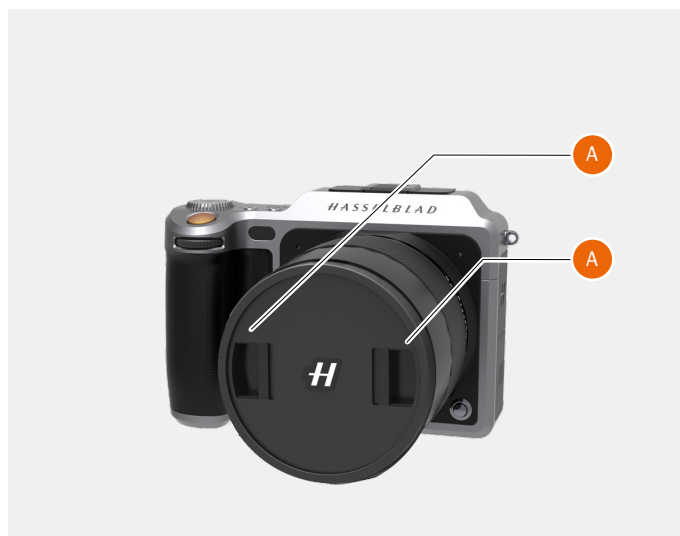

REMOVE THE LENS SHADE

All lenses are supplied with lens shades that additionally provides extra protection for transport and storage when mounted in reverse.

- 1 Turn the lens shade (A) counter-clockwise.
- 2 Remove the lens shade (A).



ATTACH THE LENS SHADE

All lenses are supplied with lens shades that additionally provides extra protection for transport and storage when mounted in reverse.

- 1 Place the lens shade on the lens.
- 2 Make sure that the index on the lens shade (A) aligns with the index on the front of the lens (B).
- 3 Turn the lens cap clockwise until it snaps into place.



FILTERS

The filters have a threaded fitting of 67 mm for both the XCD 45 mm and the XCD 90 mm lens, and are rotated clockwise into place. The XCD 30 mm and XCD 120 Macro lenses use a 77 mm filter.

As there is no rotation of the front section of the lens when the focus is changed, the filter do not rotate either. This is particularly useful when using polarizing or graduated filters where the orientation is critical.



Hasselblad XCD 30 Lens, 77 mm filter



Hasselblad XCD 45 Lens, 67 mm filter



Hasselblad XCD 90 Lens, 67 mm filter



Hasselblad XCD 120 Macro Lens, 77 mm filter

3.16 DISPLAY INFORMATION

Viewfinder information

ISO (100).
Battery Status.
Exposure Adjust (0.0).
Aperture setting (f/11).
Shutter speed (1/125).
Remaining Capture Counter (621).

See details on page 58.



PHOCUS / PHOCUS MOBILE INFORMATION

Metering method.
Aperture setting.
Shutter speed.
Exposure method.
ISO.
White Balance.
Flash indication.
Focus.
Drive.
EV.

Touch Display information Control Screen

White Balance (Daylight).
Focus Mode (AF-S).
ISO (100).
Aperture (f/5.6).
Shutter (1/125).
EV (12.0).
Exposure Adjust (+1.0).
Exposure Mode, Manual (M).
Meter Method (Spot).
Drive Mode (Single).
Remaining Capture Counter (256).
Storage medium (SD2).

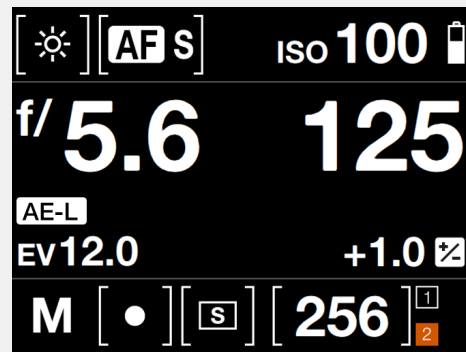

3.17 TOUCH DISPLAY AND CONTROLS

When shooting, the X1D Touch Display with Live View displays the information most often required for a quick settings check. The Front and Rear Scroll Wheels and Camera Buttons together with the Touch Display are used to navigate the Main Menu and change settings.

The Touch Display can show all saved captures on SD card 1 and 2. You can Browse and Zoom in the Captures for detailed inspection.

When shooting, you can control the amount of information visible together with the current preview by choosing various modes. See options on page 61.



Buttons and Scroll Wheels

In Browse mode, the Scroll Wheels and AE-L buttons are used for navigation.

Activate Browse mode by a single Press on the top button to the right of the Touch Display.

Here you see the Main Menu on the Touch Display. Swipe Down to display the Control Screen.



Control Screen with Settings and Information

The Control Screen is interactive. Swipe down to display the Control Screen. Select any of the settings to change the value. Aperture setting, shutter speed, focus setting, drive, EV, battery status, exposure method, capture counter, ISO and white balance can simultaneously be displayed and changed in the Control Screen on the Touch Display. Swipe Up to close the Control Screen and return to Main Menu.



3.18 ELECTRONIC VIEWFINDER DISPLAY EVF

TYPICAL VIEWFINDER DISPLAY

Touch Display



Electronic Viewfinder Display EVF visual user interface

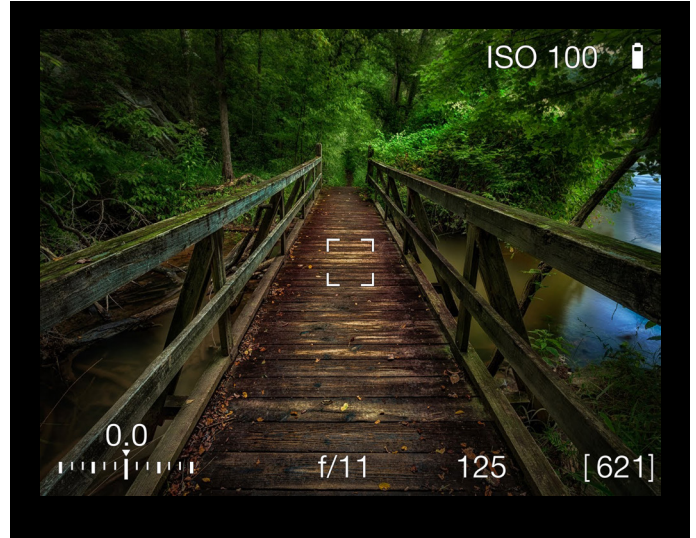

A detailed diagram of the EVF visual user interface with callouts for various elements:

- Wi-Fi:** Callout to the Wi-Fi icon in the top left.
- Flash Status:** Callout to the flash icon in the top left.
- GPS Status:** Callout to the GPS icon in the top left.
- Self Timer:** Callout to the '10' timer icon in the top left.
- Focus Area Indicator:** Callout to the green square focus area in the center.
- ISO Setting:** Callout to 'ISO 100' in the top right.
- Battery Indicator:** Callout to the battery icon in the top right.
- Manual Focus:** Callout to the 'MF' indicator in the top right.
- Spot metering area:** Callout to the small square in the bottom right.
- Exposure Compensation Setting (0.0 EV):** Callout to the '0.0' exposure compensation value at the bottom left.
- AE Lock:** Callout to the 'AE-L' indicator at the bottom center.
- Aperture (f/11):** Callout to the 'f/11' aperture value at the bottom center.
- Exposure adjustment:** Callout to the exposure adjustment icon at the bottom center.
- Electronic shutter:** Callout to the 'E' indicator at the bottom center.
- Shutter Speed (1/125 sec):** Callout to the '125' shutter speed value at the bottom center.
- Remaining Frames Counter (621 left):** Callout to the '[621]' remaining frames counter at the bottom right.

VIEWFINDER DISPLAY SETTINGS

AF indicator

The square AF indicator in the middle of the Electronic Viewfinder displays if the Autofocus is set properly or not. Start the Autofocus function by a soft half-press on the Shutter Release Button or by pressing the AF Drive button (AF-D).

- Black - Normal mode. Autofocus is not analysing the subject.
- White - Autofocus is ongoing and analysing the subject.
- Green - Autofocus performed and focus is set correct.
- Red - Autofocus failed to focus and is not set correct.

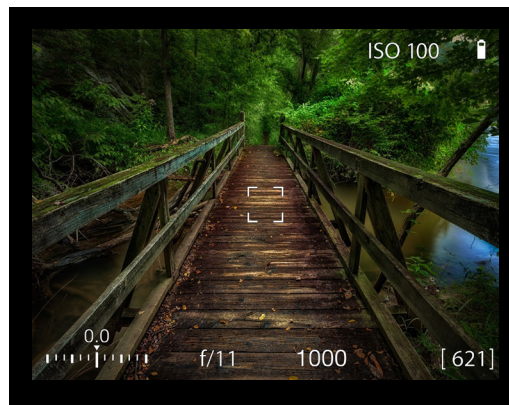

White AF indicator. Normal mode.

ISO Indicator

Displays the selected ISO setting (ISO 100).

Battery Indicator

Displays the Battery level.

Exposure Compensation Setting

Displays the EV compensation setting (0.0).

Aperture Setting

Displays the selected Aperture Setting (f/11).

Shutter Speed Setting

Displays the selected Shutter Speed setting (1/1000 sec).

Remaining Frames Counter

Displays remaining Frames (621 left).



Green AF indicator. AF set correct.

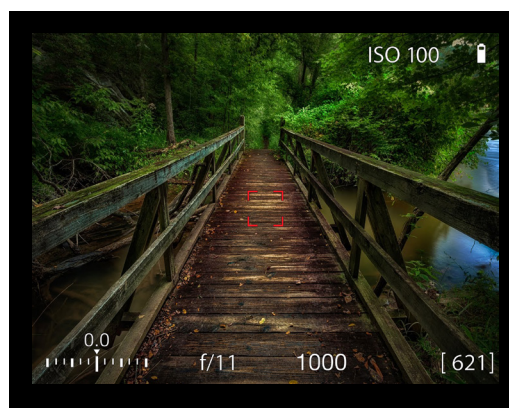

Red AF indicator. AF analysis failed to focus.

CAMERA LIVE VIEW

The Camera features Live View on the Touch Display by default.

In Camera Mode

Press once on the soft button marked with a star to the right of the Touch Display to Zoom in to 100%. This gives you a detailed view of the focus in the focus area. Rotate the Focus Ring on the Lens to adjust Focus.

In Zoom-in mode, you can pan the image shown in the EVF with the Touchpad function. See Touchpad settings on page 119.

Press the star button again to exit Zoom.

In full image view, you can select from four overlays with different information. This is described on the next page.

In Video Mode

Press once on the soft button marked with a star to the right of the Touch Display to Zoom in to 100%. This gives you a detailed view of the focus in the focus area. Rotate the Focus Ring on the Lens to adjust Focus.

Press the star button again to exit Zoom.

Exposure, ISO, Battery and Time information is displayed during Video Recording.

Note!

You can add a grid overlay to the Video Live View. See page 115.

This Chapter continuous on the next page.

Touch Display, Live View example with grid overlay



Touch Display, Video Display when capturing video

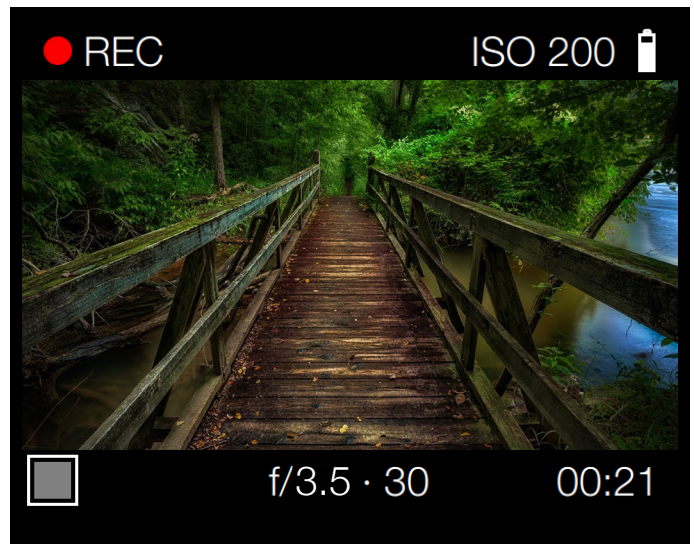

LIVE VIEW

This feature is useful for accurate focusing, composition and depth of field preview.

- 1 The Camera displays Live View when you half-press Shutter Release Button.
- 2 Press button B to step to next overlay.
- 3 Button A, or E, to Exit Live View.

Note!

If you activate the EVF (Electronic Viewfinder) by approaching the EVF with your eye and start looking into it, the Live View function for the Touch Display will turn off the Touch Display (to save battery) with the help of a proximity sensor to the right of the EVF display. If you switch back again and look at the Touch Display, the EVF is turned off and the Touch Display is activated.

Live View Settings

Overlay

Select Overlay displayed during Live View. Scroll between options with button (B).

- Exposure information (F).
- Exposure information + Grid (G).
- Exposure information + Spirit Level (H).
See chapter Spirit Level on page 126 for details.
- None (I).

ZOOMING IN LIVE VIEW

- 1 Double tap on Touch Display, or press the soft button marked with a star (C) to the right of the Touch Display, to Zoom in to Actual Pixel Size (100%) to that specific area.
- 2 Double tap again to Zoom out to display the entire Capture.
- 3 You can move around the image when zoomed in by swiping.

FOCUS IN LIVE VIEW

- 1 Double tap on Touch Display, or press the soft button (C) marked with a star to the right of the Touch Display, to Zoom in to selected Focus Area.
- 2 Adjust Focal Point manually on the Lens.
- 3 Double tap or press on the soft button again to Zoom out to Display the entire Capture.

Note!

Live View demands higher power consumption than normal operation. Working with Live View will shorten the usage time of the Camera when on battery only power supply.

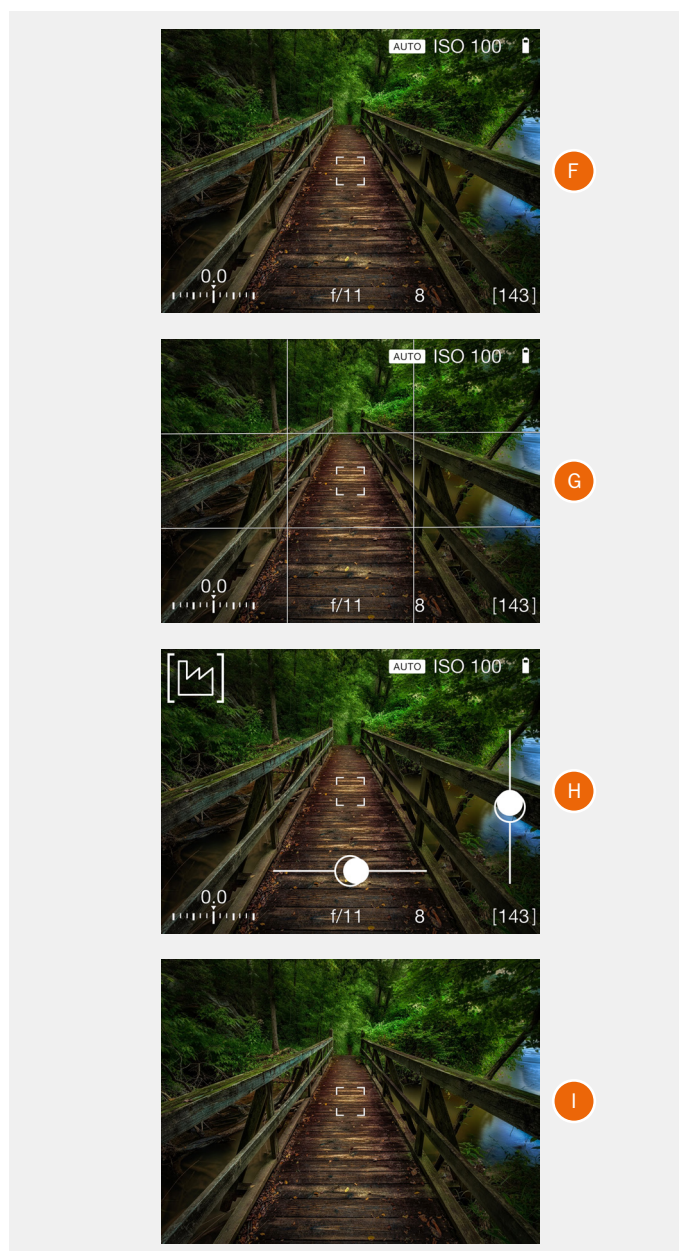

LIVE VIEW WITH HDMI EXTERNAL SCREEN



Connect an external Video Screen to the HDMI connector socket (1). On the Main Menu select LV Live View.

Touchpad (described on page 119) can be used with an external screen connected to HDMI, in two ways:

1. In Zoomed in mode, touchpad can be used to pan the image.
2. In normal mode, the AF point can be moved using the touchpad function

Note!

Live View demands higher power consumption than normal operation. Working with Live View will shorten the usage time of the Camera when on battery only power supply.



3.19 FOCUS

FOCUS ASSIST

The X1D camera features automatic focus assist. A white rectangle marked green in the middle of the view provides confirmation of a precision focus setting and are a useful aid when making a setting with Auto Focus.

Manual focus setting

Manual focus can be used at any time even in Auto Focus Mode. You can also switch to Manual Focus Mode and only use the Focus Ring manually on the lens.

- 1 Press once on the soft button marked with a star to the right of the Touch Display to Zoom in to 100%. This gives you a detailed view of the focus in the focus area.
- 2 Rotate the Focus Ring on the Lens to adjust Focus.
- 3 Press the star button again to exit Zoom.

For users who prefer manual focus control but would like the benefits of autofocus, one method is to set the AF-D button to AF (Single) drive. The main subject can then be centred and the AF-D pressed, to ensure correct focus. The camera reverts immediately to manual focus control when the button is released. Therefore, you can recompose the picture without having to maintain pressure on the release button in order to retain the newly automatically made focus setting.

Note!

The Camera will only display a green or red AF Focus Assist indication when in AF mode. In Manual Focus mode the Camera will not display any Focus Assist feedback.

Note!

Lens corrections can be applied when captures are imported into Phocus. Guided by the information in the meta data included with each individual capture, the DAC (digital lens correction) tool uses lens-model specific calculations to adjust for chromatic aberration, distortion and vignetting. Not only model specifications but also capture parameters are taken into consideration for analysis. This extremely capable refinement of captures should not be overlooked when processing files! See Phocus User Manual for details.

Note!

The autofocus function is not possible with certain combinations of lenses and accessories. However, a warning is displayed which disappears after confirmation.



White AF indicator.

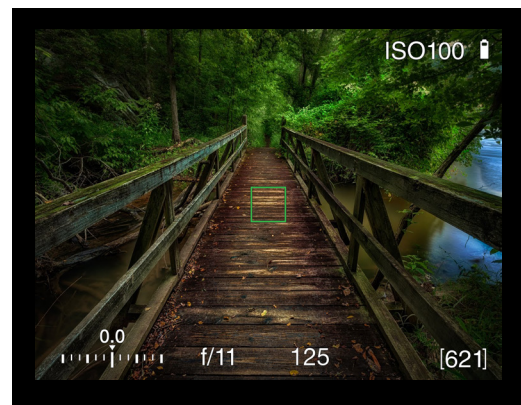

Green AF indicator. AF set correct.

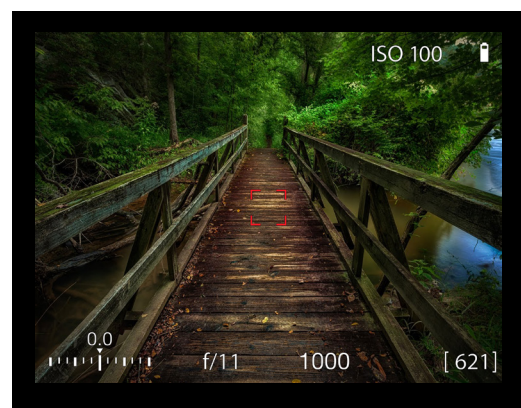

Red AF indicator. AF analysis failed to focus.

MANUAL FOCUS

There is both a Manual focus mode setting and a manual override capability.

In Manual focus mode, focusing is carried out by rotating the focus ring on the lens. The focus setting remains until changed as with a conventional non-autofocus lens. This means that pressing the shutter release button will not activate a focus setting change as it does in autofocus. To change back to autofocus, press the AF / MF button (B).

MANUAL OVERRIDE IN AUTOFOCUS MODE

Manual override is always possible in automatic focus mode without any need to make a new setting. Just rotate the focusing ring in the conventional manner. As the lens barrel does not rotate in autofocus mode, you can hold the focusing ring for instant manual adjustments. However, to retain the new manual focus adjustments, you must maintain the pressure on the shutter release button. You can instantly return to the automatic focusing mode by releasing the pressure on the shutter release button first and then pressing the release button halfway again. The instant manual override function produces a convenient way of working. You can take advantage of autofocus while retaining an instantly adjustable manual focus check if preferred for pin-point accuracy without making any changes in the settings.

With manual override in autofocus mode you can manually alter a focus setting that has been made, by rotating the lens barrel and without having to change modes. As long as the shutter release button is kept at the half-press position, the new focus setting is maintained.

To reactivate the autofocus function, release the shutter release button and press again.

AUTO / MANUAL FOCUS SETTING

- 1 Press AF Button (B).
- 2 Turn the Front Scroll Wheel (A) to select Manual or AF S Single Shot.
- 3 Press AF Button (B) or Shutter Release to Save.

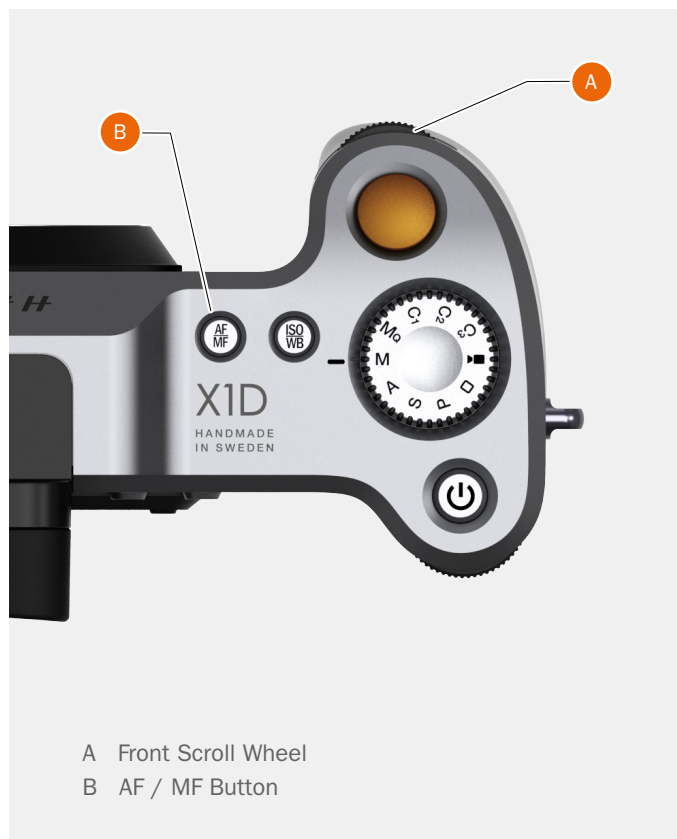

AUTOFOCUS

Autofocus is activated by pressing the shutter release to the half-press position or by pressing the AF-D button.

The operative range is from EV 1 to EV 19 at ISO 100.

Focus is determined by maximizing the contrast within the central marked area.

Alternatively, an attached flash unit that has a similar facility (a Nikon SB 600, for example) can also be used. This feature can be altered in settings.



AF Assist Light

AF Assist Light (A) is automatically activated if selected. The operative distance is approximately up to 4 metres from the camera.

Note!

You can select position of the AF point. See page 68.

It is also possible to choose from three different sizes. See page 69.

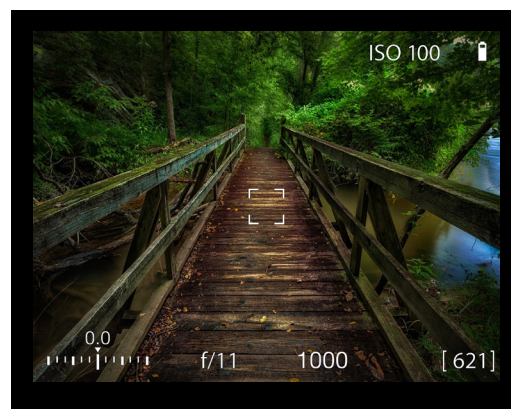

White AF indicator.

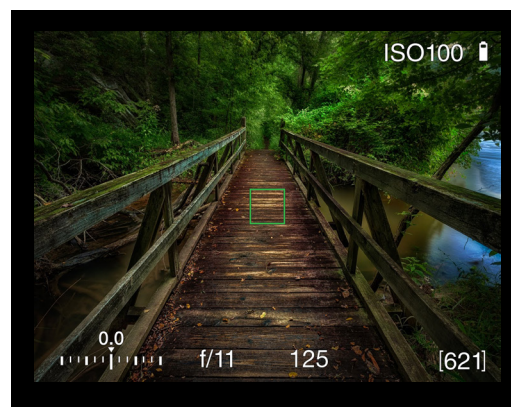

Green AF indicator. AF set correct.

SINGLE SHOT FOCUS

At Single Shot setting (AF S), the shutter release will be blocked until the camera finds the optimum focus setting. This ensures that no captures are made that are not finely focused. However, this delay is normally only a fraction of a second in good lighting conditions with a clear focusing pattern.

Note!

In this mode the lens will focus at one distance and will remain focused at that distance while pressure remains on the Shutter Release button (A).

In this way, you can focus on a nearby object, temporarily positioned within the focusing zone on the viewing screen and then without releasing pressure on the Shutter Release button (A), recompose knowing that the focus remains on the object chosen even though it is now outside the focusing zone.

Releasing the pressure on the Shutter Release button (A) and pressing again (half-press) would now change the focus setting to the distance of the object within the focusing zone.

See Manual override in autofocus mode for a useful way of working with manual and autofocus settings combined.

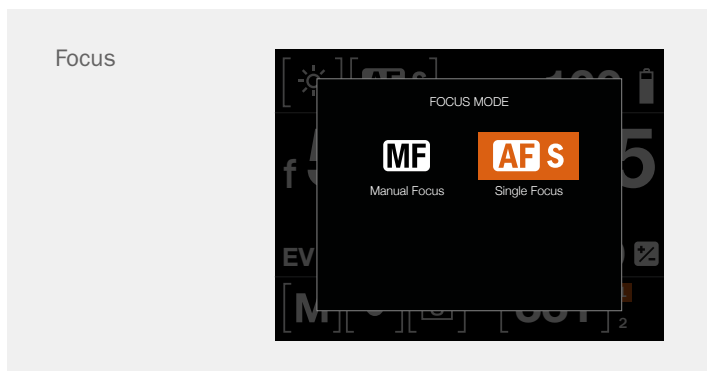

FOCUS PEAKING

Subject not in focus when Focus Peaking is active



Focus Peaking display when subject parts are in focus



How to use Focus Peaking

The Focus Peaking function is a Manual Focus tool to help you identify what areas of the subject are in focus. Focus Peaking is not active in Auto Focus mode.

When the Focus Peaking is active and you adjust the focus manually, the focused area of the subject (magenta in this case) moves in depth as you move the focus.

Manual Focus Settings Menu

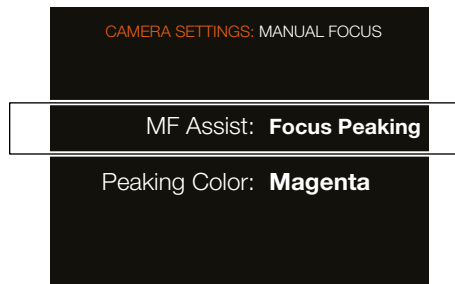

MF Assist dialogue

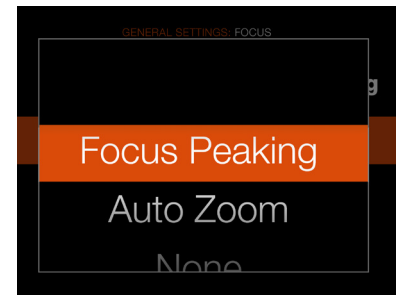

Manual Focus Settings Menu Contents

MF Assist

Manual Focus Assist. Choose between:

- Focus Peaking.
- Auto Zoom.
- None.

Peaking Colour

Select Focus Peaking Colour.

- Orange.
- Yellow.
- Cyan.
- Magenta.

Manual Focus Settings Menu

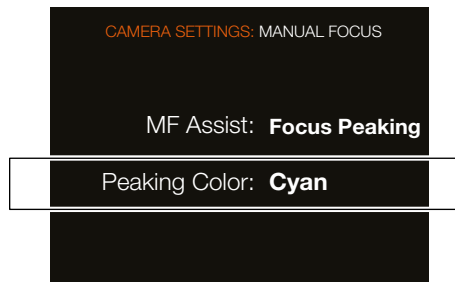

Peaking Colour dialogue

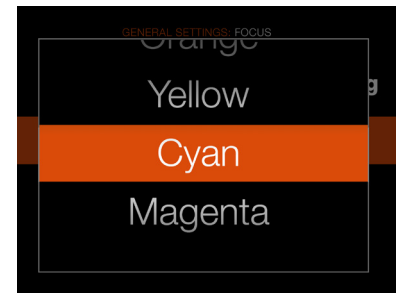

3.20 MOVE AUTOFOCUS POINT

The Autofocus point (A) can be moved, and selected manually, to any one of the 35 AF points (B). The AF point is a rectangle that measures 4 x 4, 2.8 x 2.8 or 2 x 2 mm. See page 69 for details on how to resize. Also see page 70 on how to move point while looking through the EVF.

How to move the Autofocus point on the Touch Display in Live View Mode or in the Electronic Viewfinder EVF

- 1 Start Live View Mode or use the EVF.
- 2 The single AF point is displayed in the centre position (A).
- 3 Press and hold the AF/MF button (E) for 1 second.
- 4 All 35 focus points are now displayed as an overlay (B).
- 5 Select one of the 35 AF points by tapping on the Touch Display or Rotate the Rear Scroll Wheel (M) one step left to move the AF point one step up (C).
- 6 Save and exit by a half-press on the Shutter Release button (F). The AF point is now in the new selected location (D).

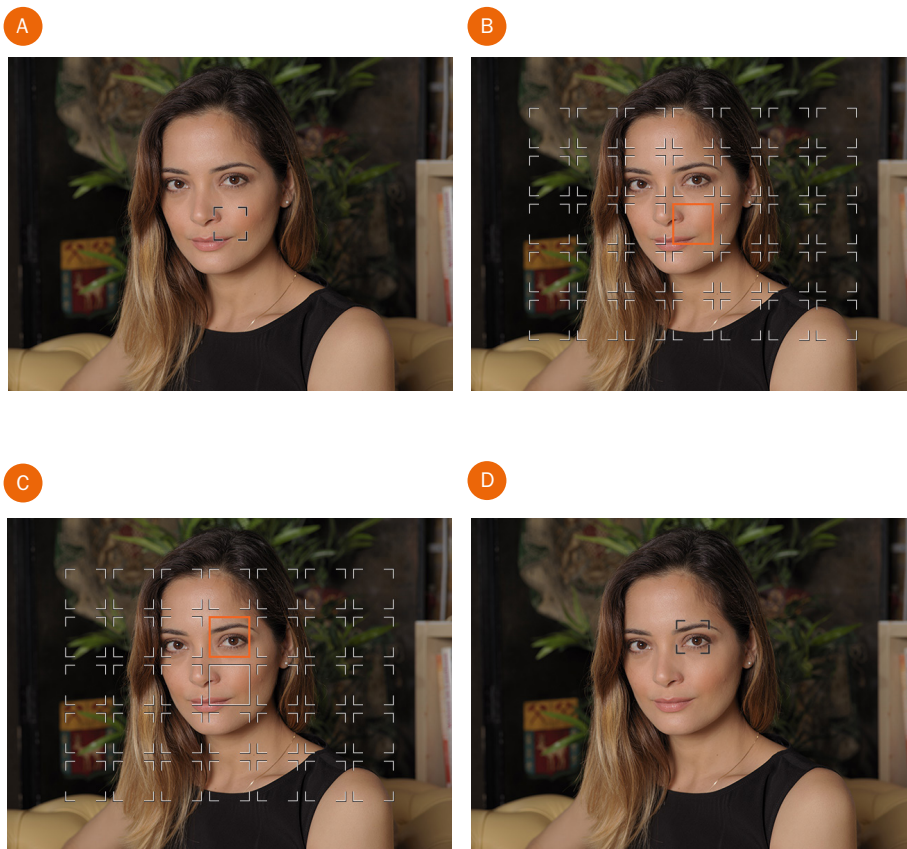

How to use the Scroll Wheels to move the AF point

AF point	Rear Scroll Wheel (M)
Move up	Rotate left
Move down	Rotate right

AF point	Front Scroll Wheel (G)
Move left	Rotate left
Move right	Rotate right

How to select AF point, save and exit

Press any of these 3 buttons:

- Half-press Shutter Release button (F).
- AF-D button (I).
- Star button (K).
- The AE-L button (H) exits without saving.

Note!

To reset the AF point back to the centre position, press the soft button (L) marked with an x.



Note!

You can set the camera to automatically reset the Focus point to the centre position after a capture, or maintain the selected position, in Main Menu > Camera Settings > Focus > Reset Focus Point.

3.21 RESIZE AUTOFOCUS POINT

The Autofocus point can be resized in the AF menu as described on page 103. It can also be resized when the AF point grid is shown by pressing the soft button (B).

How to resize the Autofocus point in Live View Mode

Start Live View Mode or use the EVF.

- 1 The single AF point is displayed in the centre position.
- 2 Press and hold the AF/MF button (A) for 1 second.
- 3 A grid with possible AF points is now shown.
- 4 Press the Soft Button (B) to cycle through the different sizes.
- 5 If required, you can select an AF point by touch or by using the scroll wheels.
- 6 Save and exit by a half-press on the Shutter Release button.

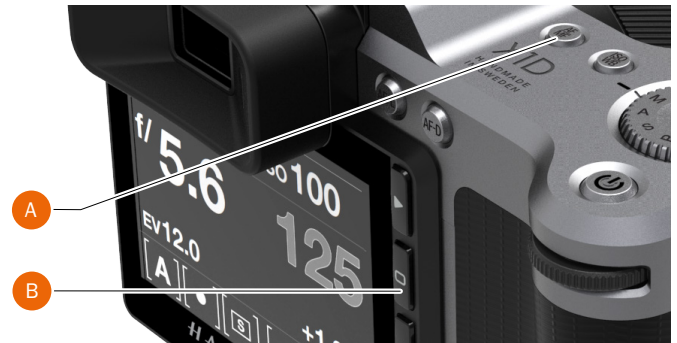

4 mm



2.8 mm



2 mm

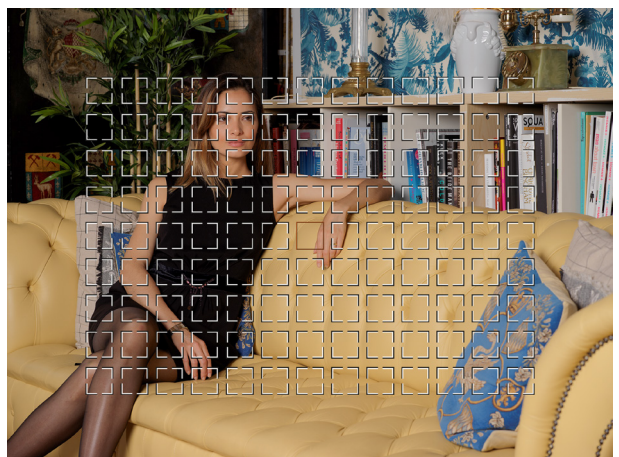

Functions

3.22 MOVE AUTOFOCUS POINT USING TOUCHPAD

The position of the Autofocus point can be changed while viewing through the EVF by sliding a finger on the rear display.

Make sure that the setting “Touchpad for EVF” in the Autofocus menu is set to the desired option. See details on page 119.

Possible settings are:

- Right
- Left
- Top-Right
- Top-Left
- Bottom-Left
- Bottom-Right

Which setting you should use, mainly depends on which eye you use when looking through the EVF. If the right eye is used, a good starting point is to set “Right”. This will use the right half of the screen as a touchpad for moving the AF point.

Moving the AF point

In this example, the “Touchpad for EVF” is set to “Right”.

While looking through the EVF, place your finger on the right part of the rear display and slide upwards and slightly to the left. In the EVF you will see the AF point moving, and when you have the desired position, you can release the finger from the rear display. However, it is not necessary to release the finger before the exposure. The AF point will stay in its position until changed. If the option “Reset Focus Point” is set to “After Exposure” (See page 103), the Focus Point will return to center after the exposure.

Note!

The movement of the AF point is relative, similar to a touchpad on a laptop computer. This means that if you cannot move the AF point far enough in one movement, lift the finger and return to the starting point and repeat the movement.

AF Point in the center



Slide the finger on the rear display to move AF point



AF Point moved



3.23 STOP DOWN BUTTON

STOP DOWN / DEPTH-OF-FIELD PREVIEW

Stop Down functionality

The Aperture normally stops down only during the exposure. In all other situations the Aperture is completely open.

The Viewfinder and the Touch Display will, as a result, show a narrow depth-of-field regardless of the current Aperture setting.

How to preview the depth-of-field

A visual depth-of-field preview check can be made by following these instructions.

- 1 Press the STOP DOWN button (A).
- 2 Hold the button (A) pressed down.
- 3 The lens is stopped down to the current Aperture setting.
- 4 A depth-of-field preview is displayed in the Viewfinder and on the Touch Display screen, as long as the STOP DOWN button (A) is completely pressed down.
- 5 Verify the depth-of-field optically in the Viewfinder or on the Touch Display screen.
- 6 Release the STOP DOWN button (A) to open up the Aperture fully again.

Note!

Depth-of-field is not absolute. Perception of it depends on several factors and so it should be seen only as a rough guide.



3.24 CHANGE SETTINGS ON THE GRIP

How to change AF/MF and ISO/WB settings

AF / MF modes

- 1 Select AF/MF (D) on top of the Camera Grip.
- 2 Press the AF/MF button to toggle between AF and MF.

ISO / WB modes

- 1 Select ISO/WB (C) on top of the Camera Grip.
- 2 Press once on the ISO/WB button to select ISO.
- 3 Press twice to select WB.
- 4 Press a third time to exit.

ISO Change ISO mode (C) by scrolling the Rear or Front Scroll Wheel (A) left or right.

WB Mode Change WB mode (C) by scrolling the Rear or Front Scroll Wheel (B) left or right. When in WB M Manual Mode, use Rear Scroll Wheel (B) to select setting.

Mode Dial

Mq	Manual Quick Mode.
M	Manual Mode.
A	Aperture Priority Mode.
S	Shutter Priority Mode.
P	Program Mode.
Rectangle	Automatic Mode. ISO are also automatically set. Several functions are limited or locked.
Video	Video Mode.
C3	Custom Program 3.
C2	Custom Program 2.
C1	Custom Program 1.

Manual Quick Mode, Mq

When selecting the Manual Quick Mode (Mq) the Shutter is closed and the Aperture is set to selected value. The Live View is turned off. This results in the shortest possible reaction time as well as saving battery time.

Custom Modes

C3, C2, and C1 are Custom Modes that can save the complete Camera settings in the Camera Memory for quick access to favourite settings.

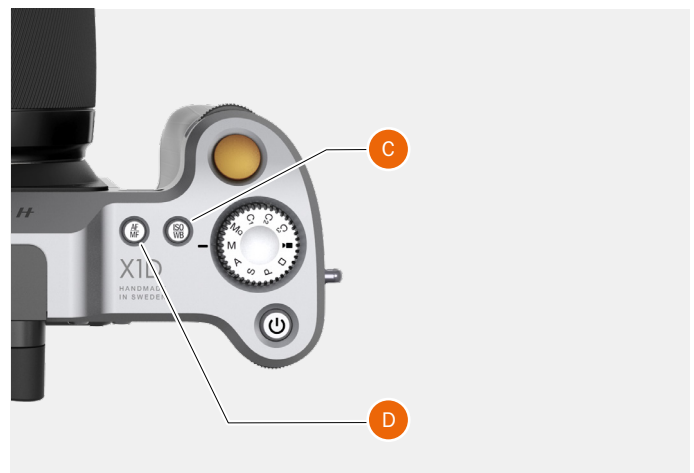

TO ADJUST SHUTTER AND APERTURE ON GRIP

Note!

In manual mode both the shutter and aperture are electronically controlled and are adjusted by the Scroll Wheels on the grip.

Note!

There are no separate manual setting rings on the lenses or camera body. The settings are displayed in the viewfinder display.

How to adjust shutter and aperture

Turn the Front Scroll wheel (A) to adjust shutter and aperture.
Turn the Rear Scroll wheel (B) to adjust shutter and aperture.

In Manual mode (M):

- Front wheel = Aperture.
- Rear wheel = Shutter speed.

In Aperture priority (A) mode:

- Front wheel = Aperture.
- Rear wheel = Quick exposure adjustment of Shutter speed.

In Shutter priority (S) mode:

- Front wheel = Shutter Speed.
- Rear wheel = Quick exposure adjustment of Aperture.

In P mode:

- Front wheel = Aperture/shutter speed combination.
- Rear wheel = Quick exposure adjustment.



ISO AND WHITE BALANCE

ISO and White Balance are set either on the Camera Grip, the Touch Display or, when tethered, in Phocus.

- On the Camera Grip, the ISO / WB Button (A) provides immediate access to ISO and White Balance settings. The front scroll wheel (B) and Rear Scroll Wheel (C) are used to make the desired changes. These appear on the Touch Display and in the Electronic Viewfinder (EVF).
- For the Touch Display, settings are changed on the Touch Display or by using the soft buttons next to the display.

The settings are automatically and simultaneously adjusted within the Camera and changes display on both the Touch Display and in the Electronic Viewfinder.

Note!

The changes are only displayed on the Touch Display after the settings have been saved. See more information about making manual White Balance settings in the 'Touch Display Settings' section.

ISO

- 1 Press ISO / WB button (A).
- 2 Turn the Front Scroll Wheel (B) to select ISO setting.

White Balance WB

- 1 Press ISO / WB button (A).
- 2 Turn the Front Scroll Wheel (B) to select WB (Auto AWB, Daylight, Shade, Cloudy, Flash, Fluorescent, Tungsten or Manual WB).
- 3 To set the Colour Temperature manually, turn the Front Scroll Wheel (B) until "M/WB" is displayed. Then the Colour Temperature value is displayed at the bottom of the screen.
- 4 Use the Rear Scroll Wheel (C) to set the Manual WB.

Note!

White Balance settings are technically not necessary for 3F/3FR files. The raw format files contain all the information required for correction in Phocus and/or other software, regardless of the original colour temperature of the light source or colour temperature setting of the camera at the time of exposure. If you intend to shoot RAW & JPEG or use Phocus for JPEG production and plan to deliver or print the JPEG files directly, then you should make a White Balance setting.

Note!

ISO and White Balance settings are made either on the Camera Grip or the Touch Display. The settings are automatically updated on both the Touch Display and the Electronic Viewfinder.

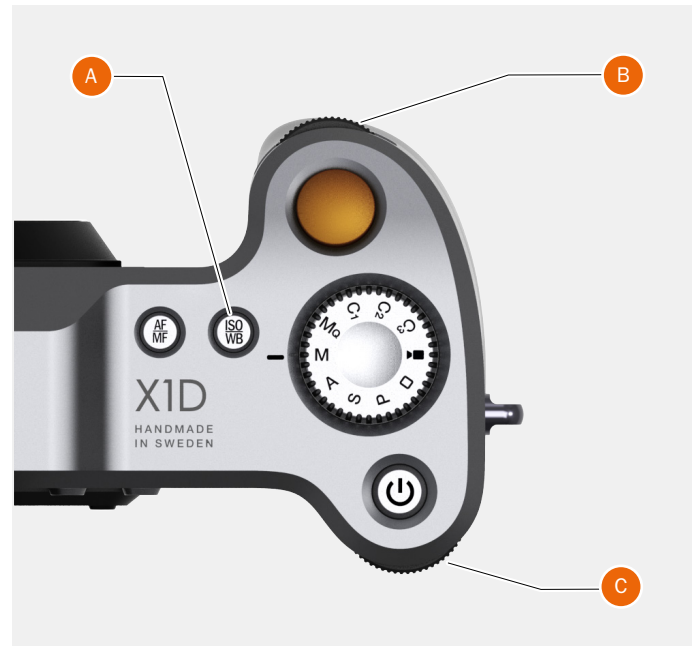

3.25 BROWSING, PREVIEW AND HISTOGRAM

BROWSE CAPTURES

Captures on the cards can be browsed on the rear display or in the EVF. Where the captures are shown, depends on which display is active when the Play / Browse Button (C) is pressed.

Browsing captures on the rear display

To enter Browse mode, press the Play / Browse Button (C) next to the Touch Display.

In Browse mode, swipe right or left or use the Front Scroll Wheel (A) on the Camera Grip to Browse captures in a folder.

In Browse mode on the rear display, swipe right or left to Browse captures.

Delete Capture with the Soft Button (D).

Zoom out to Folder View to select another folder to Browse as described on page 76.

Press Shutter Release Button (B) to exit Browse mode or press the Menu Button (E).

Browsing captures in the EVF

With the EVF active, press the Play / Browse Button (C). The last capture will be shown.

To view another image, use the front scroll wheel or swipe the rear display.

To select another overlay, use the rear scroll wheel.

You can zoom in using the AF-D button. To zoom out, use the AE-L button. A long-press (1 sec), will auto-zoom in or out. Zooming in the last image will be done around the focus point used.

When zoomed-in, you can pan the images by swiping the rear display. Which area of the rear screen that is used, can be set as shown on page 119.

Access the Delete Image Dialogue by pressing the Soft Button (D).

You can zoom out to 9-view by pressing the AE-L button in full image view. You can zoom out further to view Folders and finally select card as described on page 76 (Using buttons).

The Image Preview setting in the Camera Settings - Display menu, includes a setting where you can choose to automatically see a preview in the EVF after each capture. See more on page 117.

Video files can also be previewed in the EVF. To start video playback, press the Play / Browse Button (C).



SELECT CARD TO BROWSE

You can select SD 1 Card or SD 2 Card to Browse Captures.

To select which card to review, navigate up in the folder structure until you reach the “Select Card to Browse” dialog.

The folder structure is the following:

- Memory Cards
- Folders
- 9 images
- 1 image

It is possible to navigate to the card selection dialog either using touch or buttons and scroll-wheels.

By touch:

- 1 When viewing one image (1) Pinch inwards to go to the 9 images view (2).
- 2 In the 9 images view - Press the “Folder Up” button (A) in the top left corner to go to folders.
- 3 In the folders view - Press the “Folder Up” button in the top left corner to go to folder level above.
- 4 Select Card to Browse.
- 5 Select folder by clicking the folder name (332HASBL).
- 6 Select the image you want to view from the 9 images view.
- 7 The selected image is shown.

Or using buttons:

- 8 When viewing one image (1) - Press the AE-L button to go to the 9 images view (2).
- 9 Continue to press the AE-L button repeatedly to go up in folder structure.
- 10 Select Card to Browse using any of the scroll-wheels
- 11 Use the AF-D button to select card.
- 12 Repeatedly use scroll-wheels and AF-D button to select folder to review.

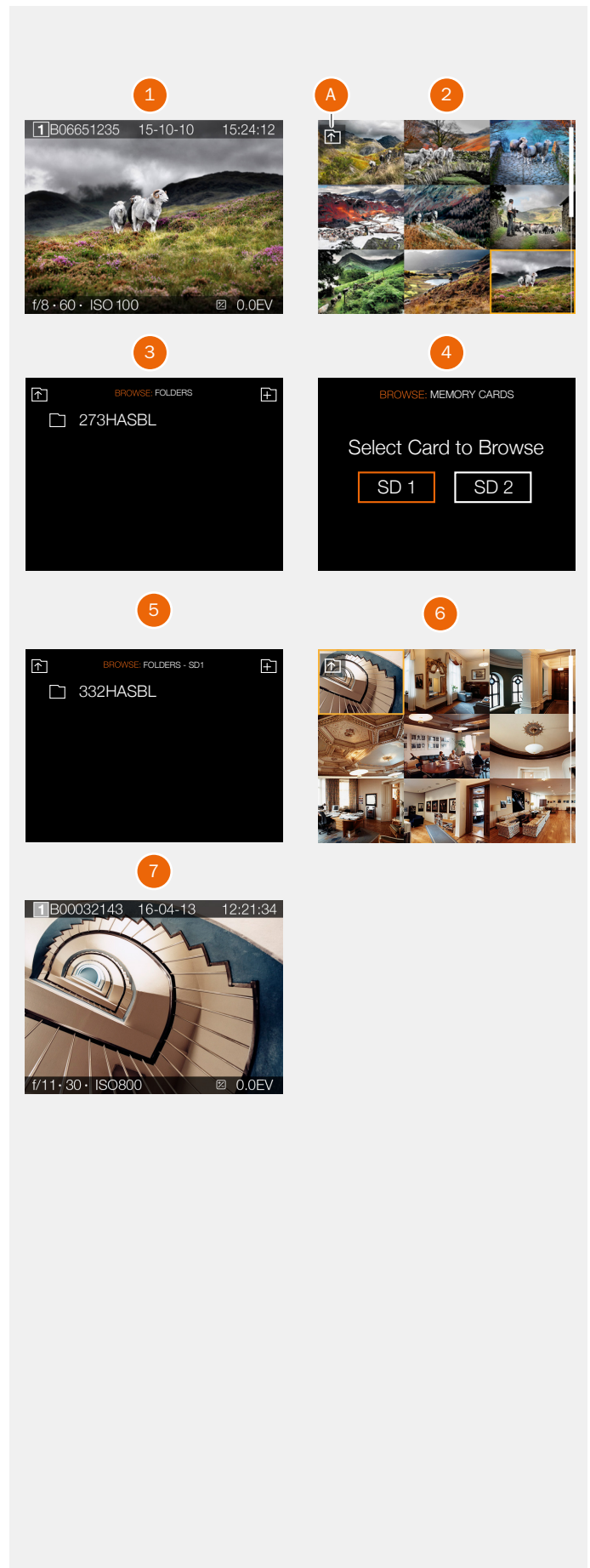

CREATE NEW FOLDER

It is possible to create a new folder on the currently active SD card. When a new folder is created, all new images will be stored in that folder. The folder name is auto-generated and cannot be changed.

It is not possible to store images in previous folder.

By touch:

- 1 When viewing one image (A), pinch inwards to go to the 9 images view (C).
- 2 In the 9 images view - Press the “Folder Up” button (B) in the top left corner to go to folders.
- 3 In the folders view - Press the “Add folder” button (D) in the top right corner to create a new folder.
- 4 In the Create Folder dialogue (E), choose **Create** to create a new folder or **Exit** to skip.

Or using buttons:

- 1 When viewing one image (A) - press the AE-L button to go to the 9 images view (C).
- 2 Press the AE-L button again to view the folder structure.
- 3 Select the “Add folder” icon (D) in the top right corner using any of the scroll-wheels
- 4 Use the AF-D button to show the Create Folder dialogue (E).
- 5 In the dialogue, choose **Create** to create a new folder or **Exit** to skip.

When the new folder is created, the folder view (F) will show the new folder. To view images in the previous folder (332HASBL), proceed as described on the previous page. New images will automatically be stored in the new folder.

Note!

It is only possible to create a new folder on the currently active card. When browsing the other card, the “Add Folder” icon will not be available.

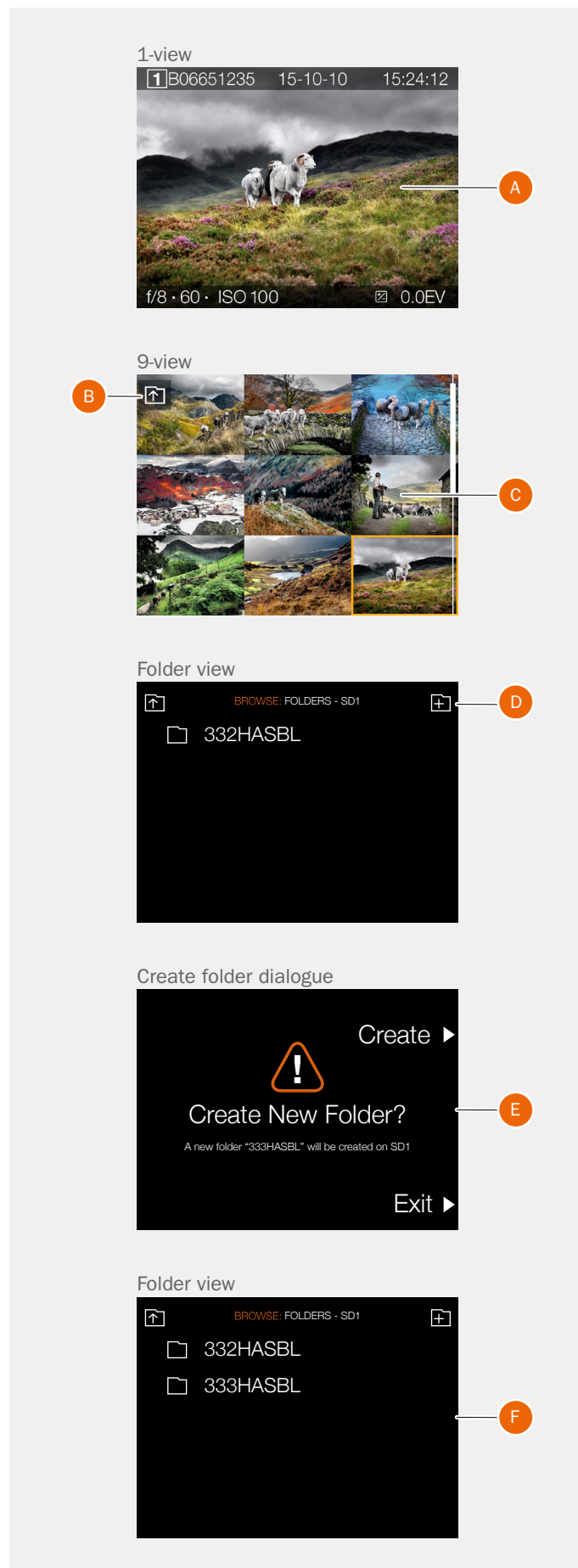

STANDARD PREVIEW

The Standard Preview is displayed when you first turn on the camera and is probably the view you will use most often.

It displays a preview of your most recent capture and basic information about the settings.

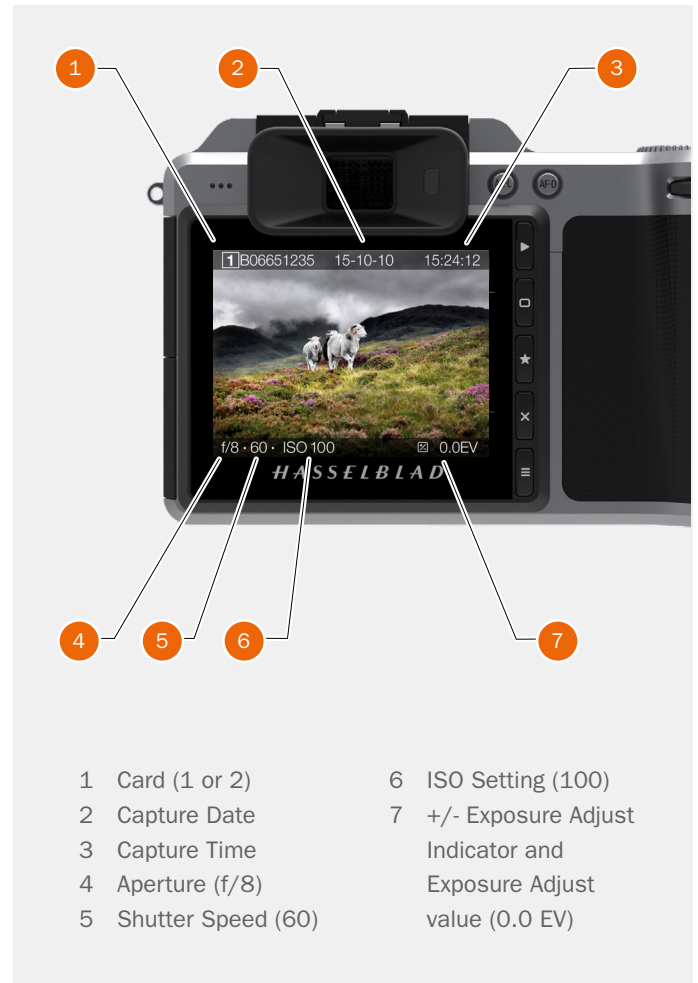

9 VIEW MODE

To display 9 View Mode, press the AE-L button when in Browse Mode. In this Mode you can see an overview of up to 9 captures. If you have more than 9 captures, swipe down to scroll through the captures.

Tap on one of the small images to view in full screen.

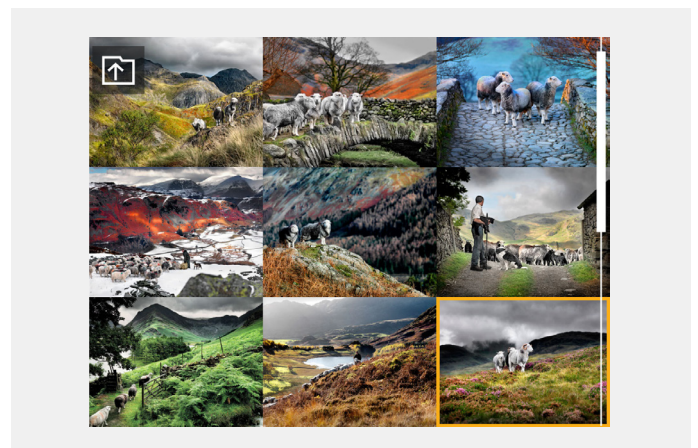

HISTOGRAM TYPES

The available Histograms are: Histogram Mode, Capture Details Mode, Luminance Histogram Mode and Separate Histogram RGB Mode.

HISTOGRAM MODE

Histogram mode displays RGB Histogram with separate RGB channels visible. The RGB details are stored with the capture file, and can be referred to in Phocus and other applications.

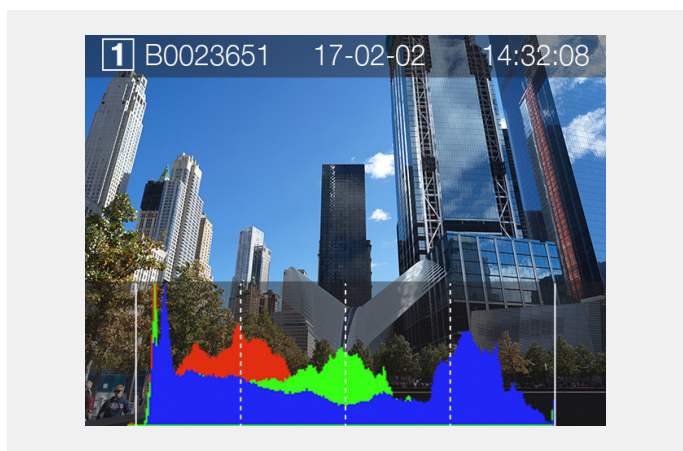

HOW TO CHANGE HISTOGRAM OVERLAY

Touch the lower part of the image or use the rear scroll wheel to alter between the available Histogram representations.

LUMINANCE HISTOGRAM MODE

The Luminance Histogram mode displays the luminosity. The luminance is represented by a White Graph.

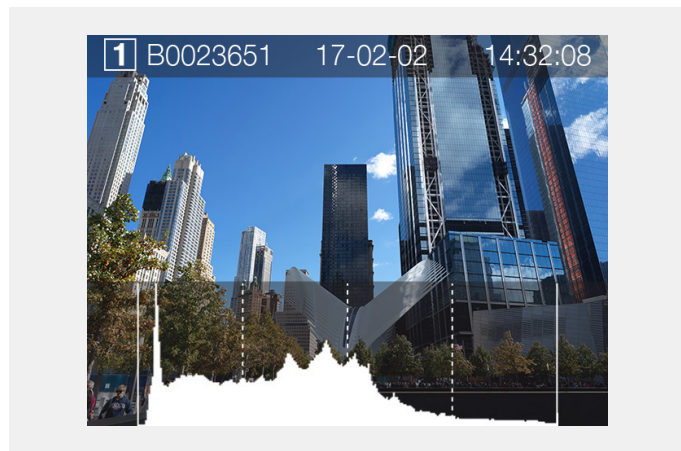

CAPTURE DETAILS MODE

The Capture Details Mode displays SD Card (1), Date (17-02-02), Time (14:32:08), selected Aperture (f/11), Shutter Speed (250), ISO (100), EV Settings (+/- 0.0), Mode (A), Light Meter Mode (Center Weighted), White Balance (Daylight) and Lens info (45mm).

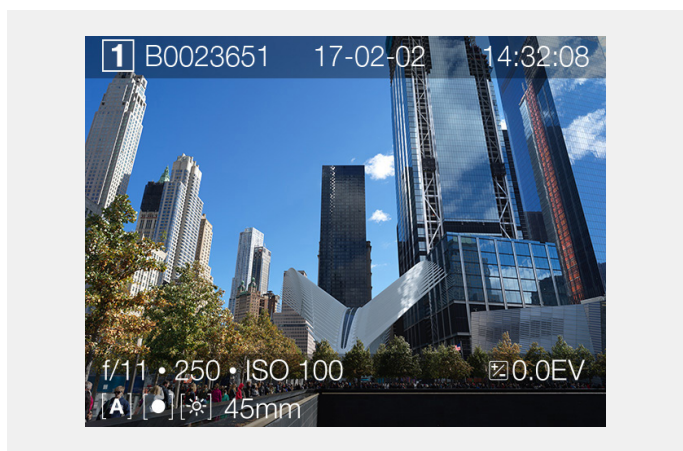

SEPARATE HISTOGRAM RGB MODE

In Separate Histogram RGB Mode, the individual RGB channels are displayed. The Red R channel first, the Green G channel in the middle and the Blue B channel below the Red and Green channels.

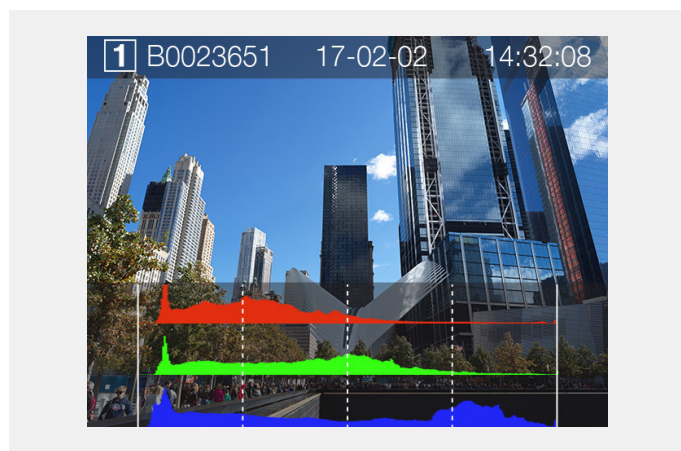

HISTOGRAM EXPOSURE MODE

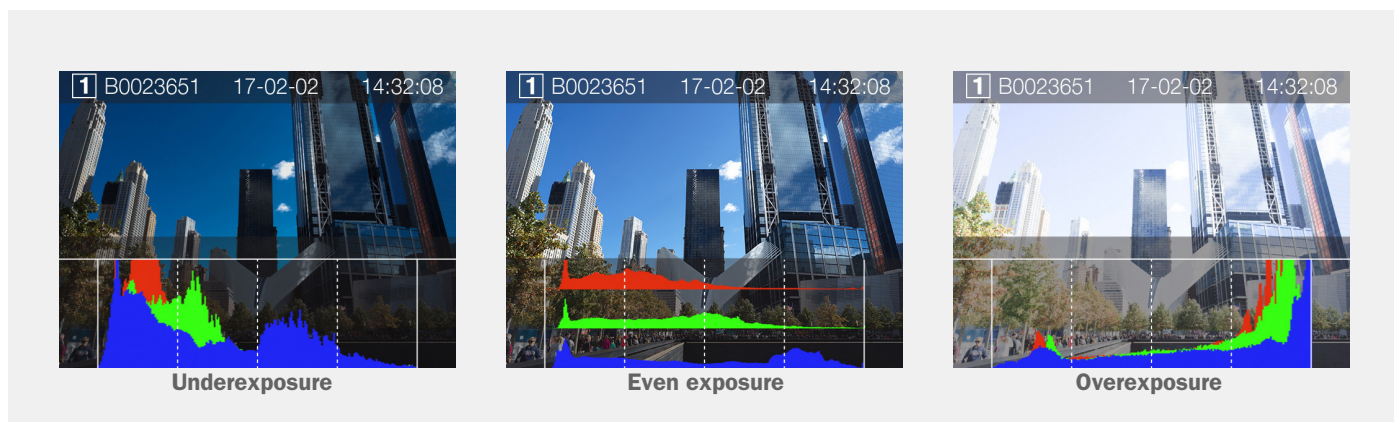

Histogram Exposure

The Histogram provides a graph that indicates the total number of pixels at each brightness level, with brightness in range from black on the left to white on the right. It is a valuable tool for evaluating captures.

A well exposed shot usually has a full range of levels, while underexposed and overexposed Captures tend to show levels concentrated at the left or right part of the scale.

The histogram is only an indicator that should be interpreted. There are several situations in which a 'bad' histogram will match an exposure that could be perfect for the intended effect.

Study the Histogram examples and the explanations below.

Underexposure

Histogram display concentrated on the left with few pixels elsewhere indicates a likely underexposure. Many details will be lost in the shadows.

Even exposure

Histogram display spread across the full range indicates a likely good exposure. There may still be a few pixels at the extremes, indicating a few spectral highlights and saturated shadows, but this is often normal in a good exposure.

Overexposure

Histogram display concentrated on the right with few pixels elsewhere indicates a likely overexposure. Many details will be lost in the highlights.

3.26 GPS MODULE

X1D has an external GPS that can be mounted in the Flash Hot Shoe. The GPS turns on automatically when it is mounted in the Flash Hot Shoe. No settings are required on the camera. The position data is tagged to each individual image file and can be read directly by Phocus. The GPS unit requires no extra external battery or power source. It works seamlessly in the background for ease of use. The position is updated once per second.

HOW TO MOUNT THE GPS MODULE

- 1 Hold the external GPS module (A) with the metallic contacts facing down.
- 2 Remove the Camera Hot Shoe protective cover from the Hot Shoe connector (B).
- 3 Insert the external GPS module in the Camera Hot Shoe connector (C).
- 4 Make sure the GPS module is inserted all the way in the Camera Hot Shoe connector.

Warning!

The external GPS module is made for the X1D Camera only. Do not attach it to any other Camera. If you attach the X1D external GPS module to any other Camera, it can result in damage to the GPS module and/or the Camera.

Note!

If the external GPS module was not included in the delivery, Hasselblad will send it free of charge, upon written request. See information in the package.



GPS ICON STATUS

The GPS icon, when active, is displayed in the top left corner in the Viewfinder and when using the Settings Menus. When the Control Screen is active, the GPS icon is displayed near the centre of the display.

The GPS state is displayed in 3 different ways:

Steady icon

GPS has obtained the position.

Blinking icon

GPS has not yet obtained the position.

No icon visible

The GPS is not yet detected by the camera or the GPS is not mounted on the camera.

Note!

There are situations where the external X1D GPS module can receive less, or no position information. These are for example when the X1D camera and GPS module are indoors, in tunnels and even in forests with large trees.

TECHNICAL SPECIFICATION FOR THE GPS

Receiver type

The GPS is a 72-channel u-blox M8 engine and it is supporting:

- GPS L1C/A.
- SBAS L1C/A.
- QZSS L1C/A.
- GLONASS L10F.
- Galileo E1B/C1.

Horizontal position accuracy

2.0 m. This includes SBAS and QZSS.

GPS icon on Control Screen

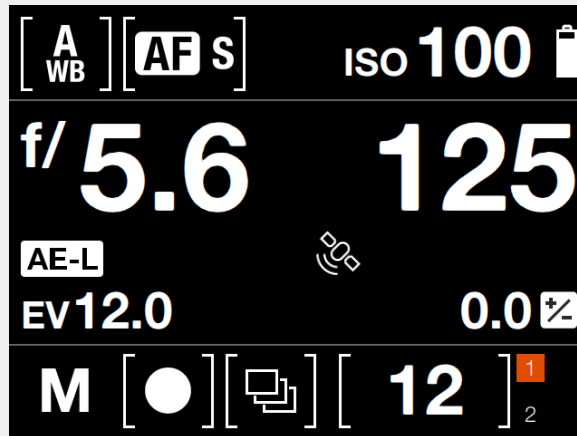

GPS icon when in Settings Menus

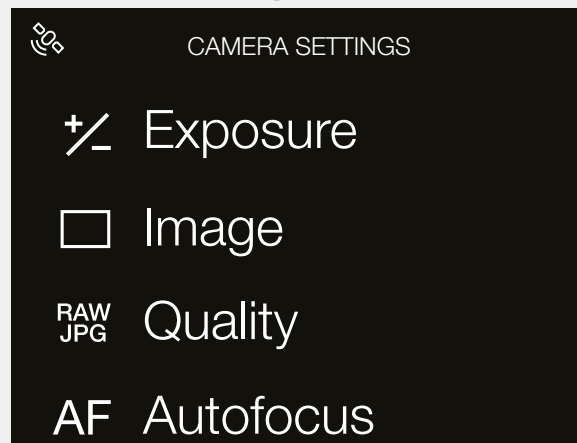

GPS icon in Viewfinder

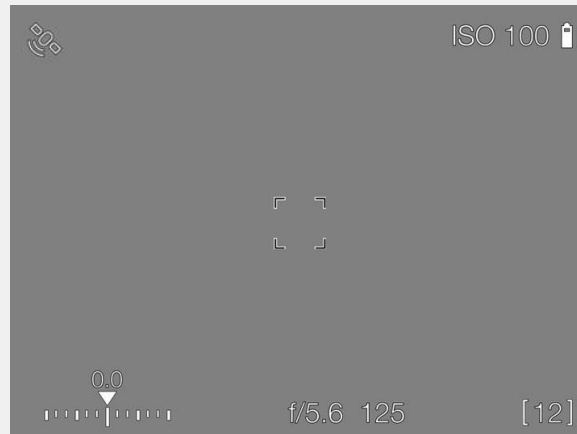

3.27 PHOCUS OVERVIEW

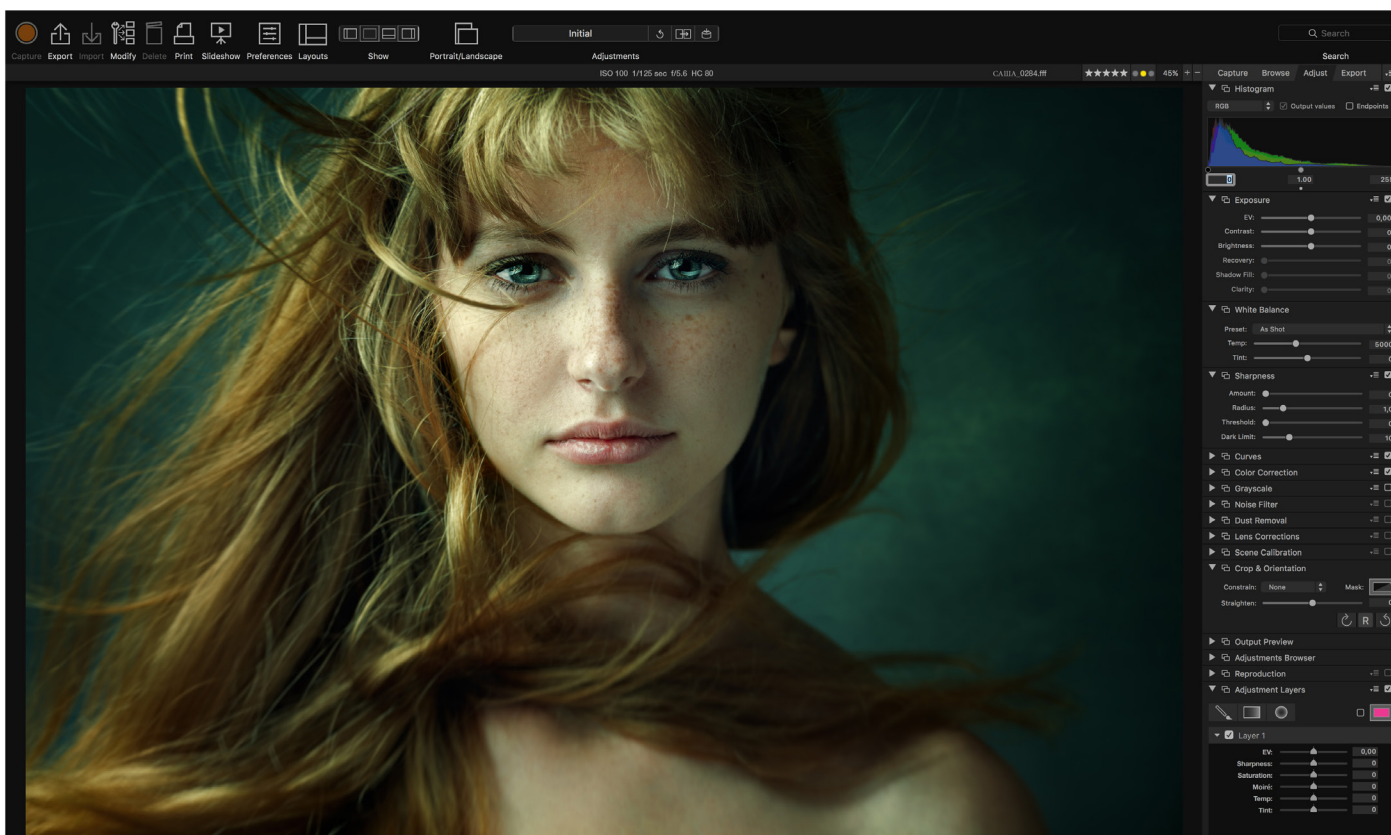

Phocus

Phocus is a Capture Processing and File Management application aimed primarily at Hasselblad 3F file handling. Phocus is available for both Mac and Windows.

Professional Image Quality

Phocus combines Hasselblad Natural Colour Solution (HNCS) with Digital Auto Correction (DAC) to provide high digital image quality in the images you create. With Phocus, the moiré effect that can occur on even extremely high resolution images is effectively removed automatically and directly on the raw data, leaving the image quality intact and saves time in post production work. Tethered shooting is efficient with Phocus Remote camera controls providing a number of remote functions. For example remote focusing, live view, aperture and exposure time controls.



Phocus Mobile

Phocus Mobile is available for iPhone®, iPad® and iPod Touch®. It enables you to connect wireless to a computer running Phocus and to remotely browse your high-resolution RAW, JPEG and TIFF images. This provides a solution for working with clients in the studio, enabling each person to view images on an individual iOS device, rather than all gathering around a single computer. Phocus Mobile also allows users to remotely operate and trigger a tethered camera, giving control of many

parameters, all neatly presented in a virtual camera display. This feature is very convenient for remote control of the camera when it's located in a difficult to access position.

Phocus Mobile is available for free. Download Phocus Mobile in the Apple App Store. www.apple.com.

3.28 PHOCUS

FEATURES IN PHOCUS

Professional Image Quality

- Hasselblad Natural Colour Solution (HNCS).
- Lens corrections for X, H and V system lenses (DAC). The X1D Camera only supports X and H Lens systems.

Specialized Tools

- Advanced Tethered Camera Controls.
- Phocus Mobile*.
- Scene calibration & reproduction tools.
- Leading edge Moiré removal.
- Highlight recovery, shadow fill, clarity and dust spot removal tools.
- Selective Adjustments.
- Easy-to-use interface.
- Extensive customization options for individual workflow scenarios.
- Import/Export of image adjustments, keywords, workflow settings.
- High quality printing.
- Slide show.
- RAW file support from more than 150 DSLR cameras.
- A tethered camera can be used as a card reader for importing images into Phocus.

Any File from Anywhere

Phocus allows you to import image files and work in the same intuitive processing environment, no matter where your files are coming from. You can browse, handle, adjust, and process all kinds of RAW and non-Raw formats.

Phocus supports RAW files from more than 150 cameras, including Canon, Nikon, Leica, Sony, Fuji, Olympus **. The most common file formats can be processed for example TIFF, JPEG, DNG, and PNG. "Not all adjustments are available for 3rd party files".

Ultimate Image Quality

Phocus combines Hasselblad Natural Colour Solution (HNCS) with Digital Auto Correction (DAC) to provide high digital image quality in the images you create. With Phocus, the moiré effect that can occur on even extremely high resolution



images is effectively removed automatically and directly on the raw data, leaving the image quality intact and saves time in post production work. Tethered shooting is efficient with Phocus Remote camera controls providing a number of remote functions. For example remote focusing, live view, aperture and exposure time controls.

* Phocus Mobile is available for free download in the Apple App Store.

** Full list available at <http://www.apple.com/aperture/specs/raw.html>

Note!

Phocus is a license free software with unlimited installations and there is no registration needed.

3.29 CONNECT TO A COMPUTER

- 1 Connect a USB 3 cable to the USB port on the computer.
- 2 Open the hinged cover on the camera.
- 3 Connect the USB 3 cable to the USB port on the camera.

When initiating a shot from Phocus, the Computer sends a signal to the X1D Camera, which triggers the shutter (and strobe/flash, if any). The Camera then sends the capture over the USB connection to the Computer, where it is displayed on the Computer Screen and saved as a 16-bit 3F file in the currently selected folder on the Computer hard disk.

Note!

When connected to a computer, the following applies:

- The destination medium and location are controlled from Phocus.
- All exposure settings, including ISO, aperture and exposure time, are controlled from Phocus if you choose to expose from Phocus. In addition extra tools such as Live Video, remote focus control are available. See Phocus user manual for full description.

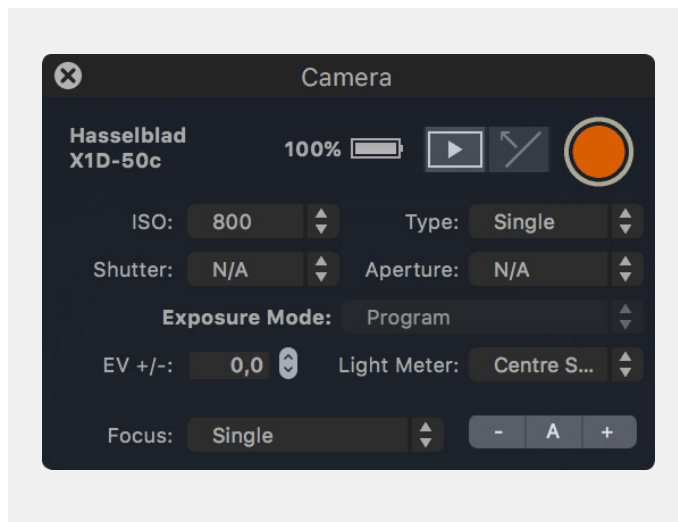

PHOCUS AND HASSELBLAD CAPTURE FILES

The X1D can capture files and store them as Hasselblad RAW format files or Hasselblad RAW + JPEG formats simultaneously.

Hasselblad RAW files are initially stored in the 3FR format which is a proprietary Hasselblad format for the temporary storage of captures. A 3FR file contains the complete digitized raw image exactly as it was captured by the camera. 3FR information requires further computing power (typically by way of Phocus) to obtain complete development. If developed in Phocus, 3FR files become Hasselblad 3F files – denoted by each file now bearing the suffix “.fff”. If developed by other RAW processors, the 3FR files are not converted to 3F but can be exported directly to TIFF and PSD according to requirements.

When working tethered (which necessitates using Phocus) 3FR files are automatically processed and stored in the background on a computer appearing as 3F files on the hard disk ready for selective adjustment and export. 3FR files stored on a SD card can be processed using:

- Hasselblad Phocus**
- Adobe Camera Raw**
- Adobe Lightroom**
- Apple Aperture**

Capture files can be stored as 3FR files (from a SD card) for later processing in Phocus or other software, or they can be stored as 3F files (as a result of tethered shooting or 3FR files processed and converted in Phocus). In all cases if you keep the original 3FR/3F files, you will also retain the possibility of reprocessing them in the future in later versions of Phocus or other software to take advantage of eventual improvements and developments.

Mixed formats

Phocus can also process most other capture formats, generic and proprietary. This means you can include other formats in your normal Phocus workflow if you choose. Or if you prefer, you can include Hasselblad files in Adobe / Apple workflows as stated above.

Note!

For best possible image result, use Hasselblad Phocus Software. Other Digital Image Software can give you a similar result, but not exactly the same as Hasselblad Phocus Software.



3.30 BATTERY

Rechargeable Battery

The environmentally approved Battery (Li-ion 3054752) is the standard Power Source for the X1D Camera (1). It is advisable to keep an extra fully recharged battery on hand. As is the case with most batteries, problems might be encountered when used in very low temperatures. In this situation it is advisable to keep the reserve battery inside a warm pocket, for example, to maintain it near body temperature.

How to remove a Battery

- 1 Remove the Battery from the camera (1) by rotating the Battery Lever (2).
- 2 The Battery will move up a bit (3) automatically.
- 3 Then press the Battery in a bit but not all the way (4), to release it from the Camera completely.
- 4 Remove the battery (5).

How to mount a Battery

- 1 Push the Battery (1) into the Camera Battery Compartment until it locks into place.



BATTERY CHARGER

The battery charger BCX-1 (3053573) is supplied with a number of plug attachments to suit various types of domestic electrical sockets available worldwide. Other types of sockets will require a domestic socket converter.

Attach the appropriate plug by sliding it into position as in the illustration to the right. Reverse the procedure to remove the plug.



CHARGE THE BATTERY

With the battery (3054752) removed from the camera, insert the jack plug from the battery charger into the socket on the battery (1). Insert the battery charger into a standard (100–240V~ /50–60 Hz) domestic socket.

During the charging procedure, the lamp on the charger signifies the following:

Steady Green light

Standby (no battery connected).

Steady Red light

Charging.

Steady Green light

Ready.

Note!

It can take about 6 hours to charge the battery completely up to 100% the first time.

See next page for more details and precautions.



RECHARGEABLE BATTERY SPECIFICATION

LHION/ BATTERY CHARGER 3053573 BCX-1
– PRECAUTIONS and GENERAL

The battery should be charged for approximately 6 hours before first time use.

The battery must be charged at room temperature.

Maximum battery capacity is reached only after the battery has been charged and discharged several times.

Avoid frequent full discharges (a full discharge is signalled by the appearance of the Replace battery warning). As the battery is a Li-ion type, it has no 'memory effect' of practical importance and therefore frequent recharges will cause no problems such as loss of capacity or poor performance. It is therefore better policy to recharge the battery at very regular intervals, regardless of use.

Remove the battery if you intend to store the camera for some while as it will eventually become completely drained, even though the camera is turned off. Mount the Battery Protection Cover when storing the Battery.

The battery has an integrated 'fuel gauge' capability that supports the Replace battery and Battery status functions. As with most Li-ion batteries, this capability should be occasionally calibrated, depending on how much the battery is used. To do this, leave the camera on (or use it), until the Replace battery warning appears. Then, recharge the battery for 6 hours. This will improve the accuracy of the measurements.

When removing a battery from the charger and immediately replacing it with another, allow a few seconds to elapse so that the charger can automatically reset for the next charging procedure.

It is perfectly normal for the battery to become warm when being charged.

A slight temporary loss of battery performance might be noticed at very high or low temperatures. Take the appropriate measures if this is the case.

If you do not intend to use the battery for a while, it is best to store it at room temperature with an approximate 30 to 40% charge. You can check the percentage level on the status screen.

The battery should have a usable service life of around 400 recharge/discharge cycles.

Connect the battery to the camera correctly.

Keep the Battery Protection Cover in place when not in use. (Short circuiting across keys in a pocket, for example, could cause a risk of fire).

Do not immerse the battery in liquids.

Do not incinerate the battery.

Please recycle or discard in an environmentally approved manner.

Use indoors only (protect against moisture).

Do not short circuit the jack plug.

Do not alter the charger in any way other than changing the plug attachment.

Note!

You can save battery consumption by changing the Display Off / Power Off settings as well as the Brightness settings of the display.

BATTERY LIFE AND BATTERY WARNING

Battery life is dependent on a number of variable factors and therefore cannot be exactly predicted. If the camera is left in the active state instead of Display Off or Sleep modes for long periods, for example, the battery will become exhausted much faster. A low camera battery level is indicated by a symbol on the display, as well as in the viewfinder.

3.31 TEMPERATURE WARNING

If you take several captures within a short period of time, the processor in the Camera will produce more heat. This, particularly in combination with high ambient temperature, can result in noise in the image files. To prevent this, the Camera displays a warning icon when the temperature rises. At approximately 60 °C a warning dialogue appears notifying that the Camera is temporarily shutting down to allow it to cool.

3.32 STORE THE CAMERA

Caution!

If you leave the camera unused for a period of time, remove the battery. This will prevent damage to the equipment.

Caution!

Keep camera and equipment away from moisture. If your camera becomes wet, disconnect from electric power and let camera dry before further use. This will help prevent damage to the equipment.

Caution!

Store the equipment in a dry environment. This will help prevent damage to the equipment.





4.1 CAMERA SETTINGS MENU

Main Menu

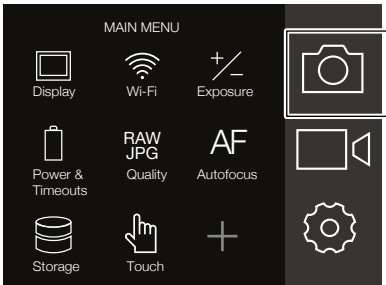

Camera icon

MAIN MENU > CAMERA SETTINGS > EXPOSURE

- 1 Press the Camera icon on the Touch Display.
- 2 The Camera Settings Menu appears.

Swipe right or press Menu / EXIT button to get back to Main Menu.

Camera Settings Menu

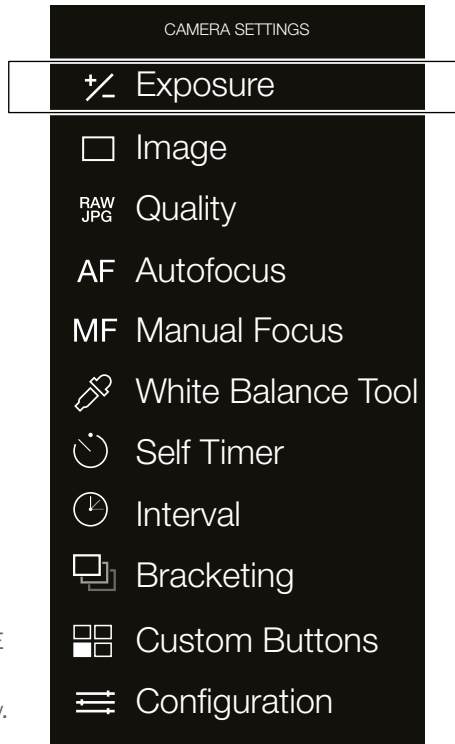

Exposure Settings Menu

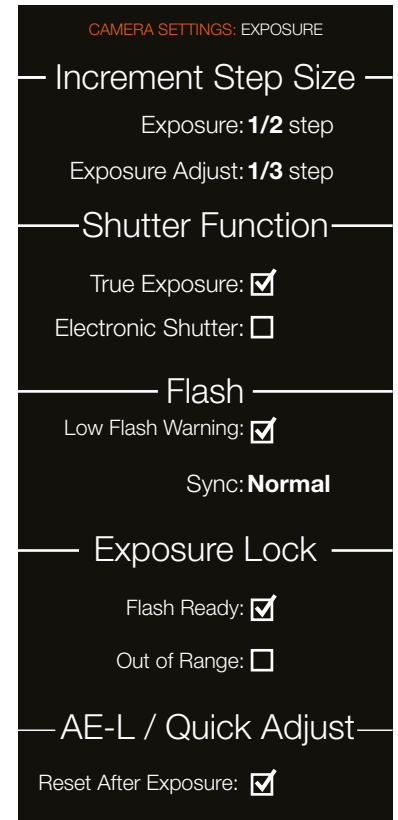

INCREMENT STEP SIZE SETTINGS

MAIN MENU > CAMERA SETTINGS > EXPOSURE > INCREMENT STEP SIZE

- 1 Press the Camera icon on the Touch Display.
- 2 The Camera Settings Menu appears.
- 3 Press the Exposure Settings Menu.

Swipe right or press Menu / EXIT button to get back to Main Menu.

Exposure

Select between 1, 1/2 and 1/3 stop increments.

Exposure Adjust

Select between 1, 1/2 and 1/3 stop increments.

Exposure Settings Menu

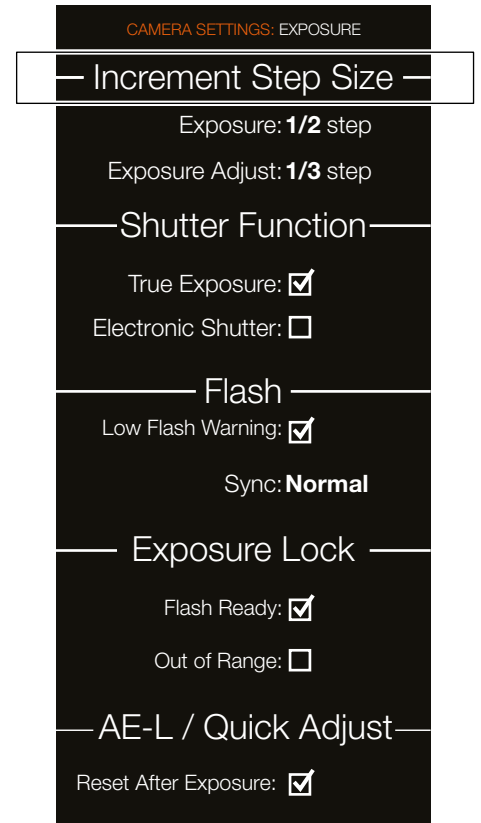

SHUTTER FUNCTION SETTINGS

MAIN MENU > CAMERA SETTINGS > EXPOSURE > SHUTTER FUNCTION

- 1 Press the Camera icon on the Touch Display.
- 2 The Camera Settings Menu appears.
- 3 Press the Exposure Settings Menu.
- 4 Select Shutter Function.

Swipe right or press Menu / EXIT button to get back to Main Menu.

True Exposure

Select On or Off. The check box will be marked with a ✓ when On and the check box is empty when True Exposure is Off.

Determines whether the exposure is automatically adjusted to create a true exposure setting. On allows the adjustment. Off retains the normal setting.

Note!

If using flash/strobe as the main light source and 1/800s or 1/1000 shutter speed (depending on lens type), remember to turn off the True Exposure option.

Note!

The True Exposure feature is designed to keep shutter speed unaffected by aperture value. See next page.

Electronic Shutter

Select On or Off. If this option is checked, the camera will disable the lens shutter and use an electronic shutter in the sensor instead. When electronic shutter is active, this is indicated with an E symbol in front of the shutter speed in Live View and on Control Screen.

Please note the following limitations with Electronic Shutter:

- The camera will use the Rolling Shutter available on the sensor which has a read-out time of approximately 300 ms. This will cause distortion of the image if the camera or subject is moving during the exposure. A tripod and a stationary subject is recommended.
- ISO will be limited to 3200.
- Full image quality is not guaranteed.
- Shutter speed range is 68 minutes to 1/10000 sec.
- Flash is disabled.
- Continuous drive is disabled.
- True Exposure is disabled.

Exposure Settings Menu

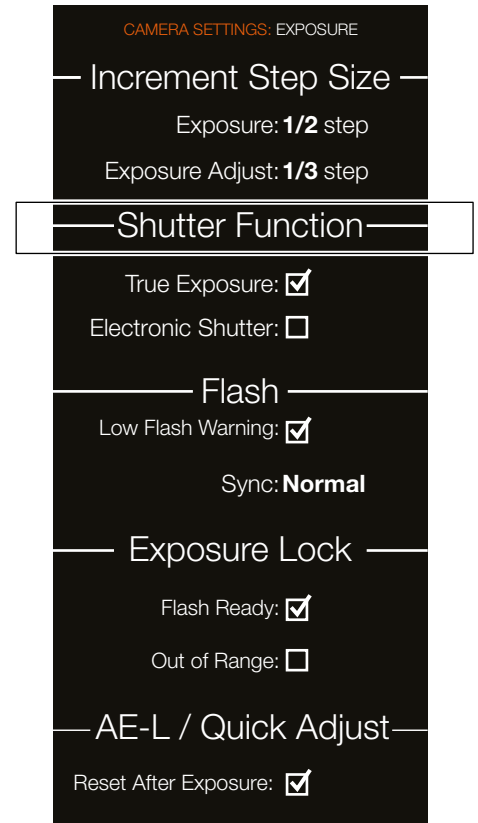

Control Screen with active Electronic Shutter



Live View with active Electronic Shutter

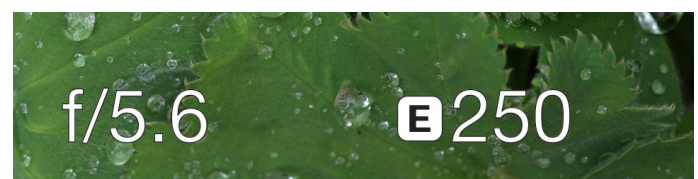

Note!

An active Electronic Shutter is indicated on the Control Screen and in Live View with an "E" next to the shutter speed.

True Exposure explained

Light level at image plane

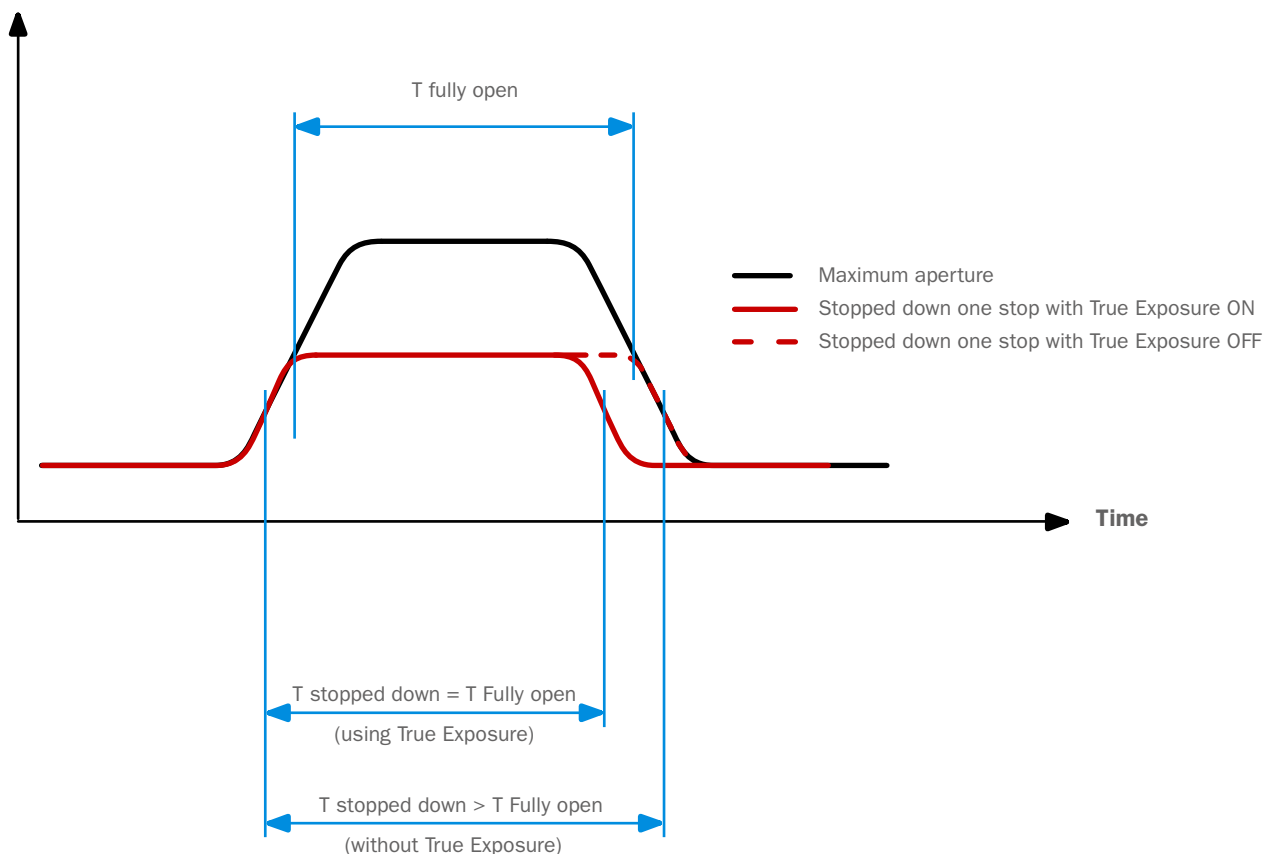

True Exposure is an XCD and HC/HCD lens function that allows the shutter speed to remain unaffected when stopping down. This effect is perhaps not so commonly understood as it is restricted specifically to integral lens shutters as opposed to focal plane shutters.

When a lens is stopped down, the effective shutter speed becomes longer, consequently affecting the set exposure. At slow shutter speeds the effect is minimal but at faster speeds, 1/500s, the effect becomes clearly visible. Automatic compensatory measures in speed setting adjustments are employed.

As compensation can only be put into effect where speeds can be adjusted, this prevents the possibility of adjusting the fastest speed of 1/800s. To counter this, compensatory adjustments

are therefore made to the aperture instead to retain the set exposure. This compensation is not always required and when using flash/strobe as the main light source it is actually undesirable because compensation will result in underexposure. Therefore, when using flash/strobe as the main light source, you should set True Exposure to OFF in Main Menu > Camera Settings > Exposure > True Exposure in the Camera Display.

You can download a complete explanation of this situation from www.hasselblad.com.

FLASH SETTINGS

MAIN MENU > CAMERA SETTINGS > EXPOSURE > FLASH

- 1 Press the Camera icon on the Touch Display.
- 2 The Camera Settings Menu appears.
- 3 Press the Exposure Settings Menu.
- 4 Select Flash.

Swipe right or press Menu / EXIT button to get back to Main Menu.

Important information!

Read the complete Chapter about flash before attaching a Flash to the X1D Camera.

Low Flash Warning

Select On or Off.
The check box will be marked with a ✓ when On and the check box will be empty when Low Flash Warning is Off.

Sync

Select Flash Sync Settings.
- Normal.
- Rear.

This Chapter continues on next page.

Exposure Settings Menu

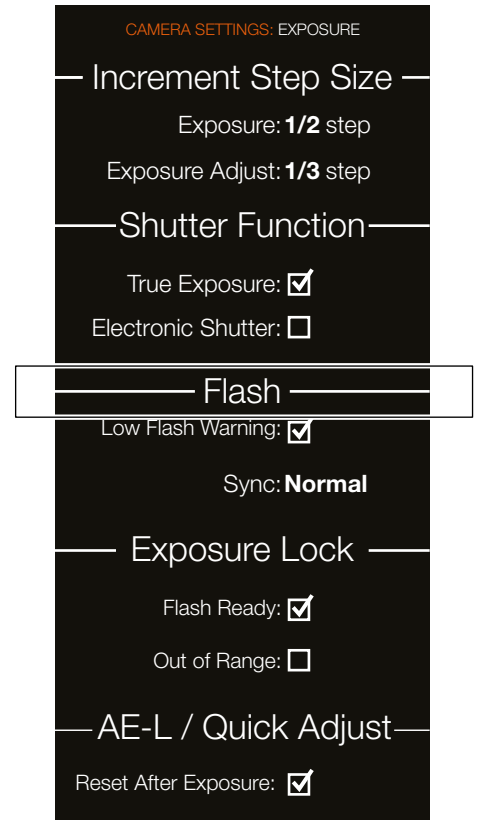

FLASH AND STROBE SETTINGS

The X1D Camera can be used together with the following flashes in TTL mode:

Nikon:

- SB-300
- SB-500
- SB-5000
- SB-700
- SB-900
- SB-910

Profoto:

- A1
- B1
- B2

General information

When using the A or S setting together with flash, the exposure requirements of the camera will dominate which might produce slow shutter speeds indoors, for example, requiring the use of a tripod. If P is selected instead, a shutter speed of 1/60 or faster is automatically chosen by the camera enabling the camera to be hand held.

When using flash close up or when using larger aperture settings, remember that the flash unit's output has a specific minimum duration which might still be too great for correct exposure. Read the back's output specifications for further information regarding any potential restrictions.

Rear sync is a useful feature used either for effect or to produce a more 'natural' look when combining long exposures involving light trails and flash.

To change the balance between flash output and camera exposure requirements to produce a variety of effects, use the exposure compensation function. For various long exposure effects use the sync function.

Notes and Warnings!

Only flash units listed to the left can be connected to the hot-shoe of the camera.

Warning!

Do not attempt to connect a flash unit dedicated for use with another camera brand, to the X1D Camera hot shoe. The flash unit and / or camera could be damaged.

Note!

If using flash/strobe as the main light source and 1/1000s or shorter shutter speed, remember to turn off the True Exposure function.

EXPOSURE LOCK

MAIN MENU > CAMERA SETTINGS > EXPOSURE > EXPOSURE LOCK

- 1 Press the Camera icon on the Touch Display.
- 2 The Camera Settings Menu appears.
- 3 Press the Exposure Settings Menu.
- 4 Scroll down to Exposure Lock.

Swipe right or press Menu / EXIT button to get back to Main Menu.

Flash Ready

Select On or Off. The check box will be marked with a ✓ when On and the check box will be empty when it is Off. Controls if an exposure is blocked if the flash is not ready to fire.

Out of Range

Select On or Off. The check box will be marked with a ✓ when On and the check box will be empty when it is Off. Controls if an exposure is blocked if aperture, and/or shutter speed, is outside the possible range.

Exposure Lock Settings Menu

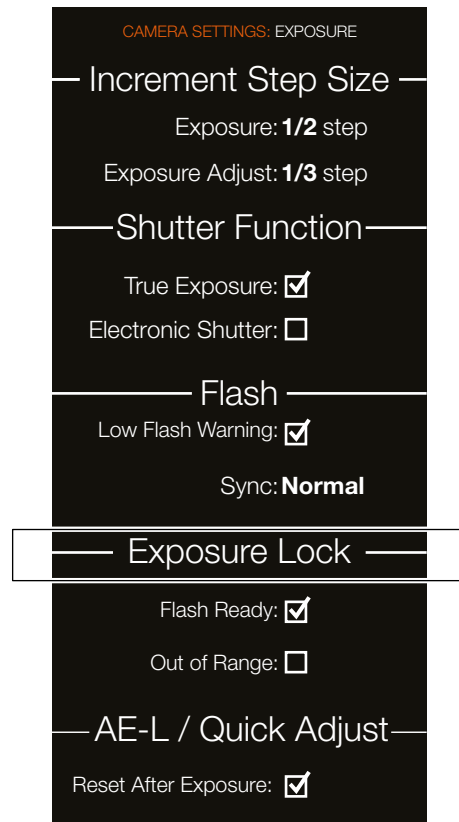

AE-L (AE-LOCK) / QUICK ADJUST

MAIN MENU > CAMERA SETTINGS > EXPOSURE > AE-L / QUICK ADJUST

- 1 Press the Camera icon on the Touch Display.
- 2 The Camera Settings Menu appears.
- 3 Press the Exposure Settings Menu.
- 4 Scroll down to AE-L / Quick Adjust.

Swipe right or press Menu / EXIT button to get back to Main Menu.

Reset after exposure

Select On or Off. The check box will be marked with a ✓ when On and the check box will be empty when Off.

Controls if a Quick Exposure Adjustment or AE-Lock state is reset by an exposure or not.

AE-Lock / Quick Adjust Menu

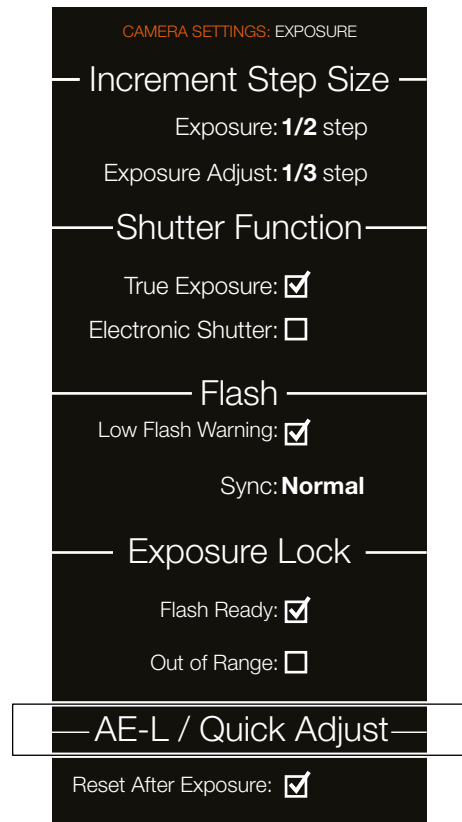

IMAGE FORMAT

MAIN MENU > CAMERA SETTINGS >
IMAGE > IMAGE FORMAT

- 1 Press the Camera icon on the Touch Display.
- 2 The Camera Settings Menu appears.
- 3 Press the Image Menu.

Swipe right or press Menu / EXIT button to get back to Main Menu.

Image Format - Crop Mode

Adds a crop mask to Live View and the RAW file. When imported to Phocus, the crop mask can be modified or removed.

Crop Mode Settings:

- No Crop (645)
- 1:1 (6x6)
- 7:6 (6x7)
- 5:4 (4x5)
- 11:8,5 (Letter)
- 297:210 (A4)
- 3:2 (6x9)
- 3:2 Crop (24x36). See Notes below.
- 16:9 (Screen)
- 2:1 (6x12)
- 65:24 (XPan)

Mask Opacity:

Sets the opacity of the mask between 20% and 100%.

Notes:

- JPG files are not cropped.
- Crop Modes are disabled in USB tethered mode.
- Crop Modes are not supported in Phocus Mobile.
- A good method is to program a button to "Crop Mode Next" or "Crop Mode Previous". This allows quick selection of crop format. A long press on this button will return to "No Crop". See page 112.
- If a button is programmed to "Crop Mode Next" or "Crop Mode Previous", 3:2 Crop (24x36) is only available when using electronic shutter and other lenses than XCD or HC/HCD. Useful when using 3rd party lenses designed for 24x36 mm format.

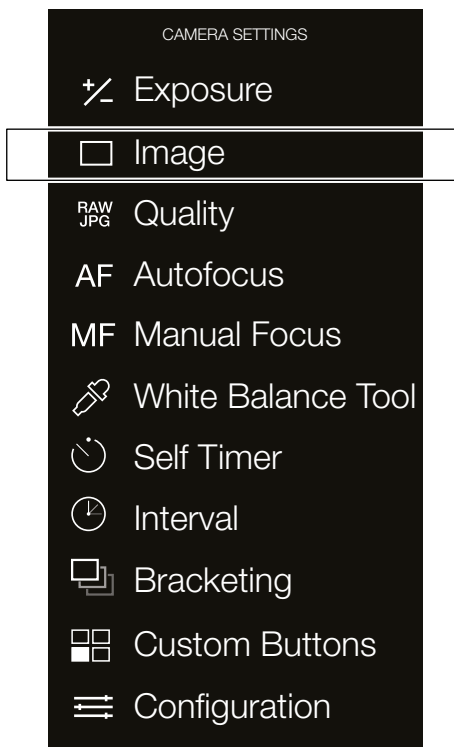
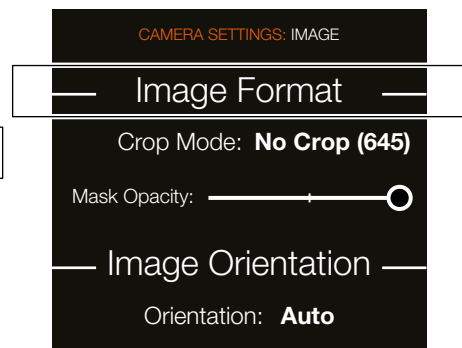

Image Format Settings Menu



XPan crop with 100% Opacity



XPan crop with 60% Opacity

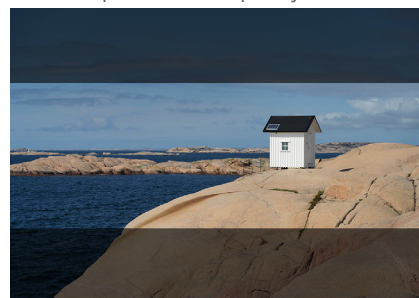

1:1 (6x6) crop with 100% Opacity

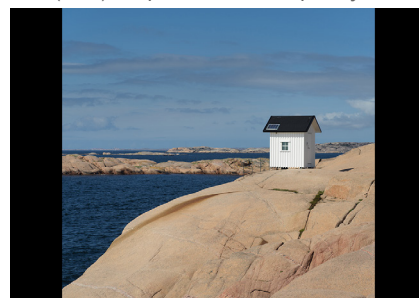

IMAGE ORIENTATION

MAIN MENU > CAMERA SETTINGS > IMAGE > IMAGE ORIENTATION

- 1 Press the Camera icon on the Touch Display.
- 2 The Camera Settings Menu appears.
- 3 Press the Image Menu.

Swipe right or press Menu / EXIT button to get back to Main Menu.

Image Orientation

Sets the viewing orientation of captures when they appear in Pocus. To avoid unintentional orientation changes when the camera is pointing straight up or down, the orientation setting can be locked.

Settings:

- Auto.
- Lock at 0 degrees.
- Lock at 90 degrees.
- Lock at 180 degrees.
- Lock at 270 degrees.

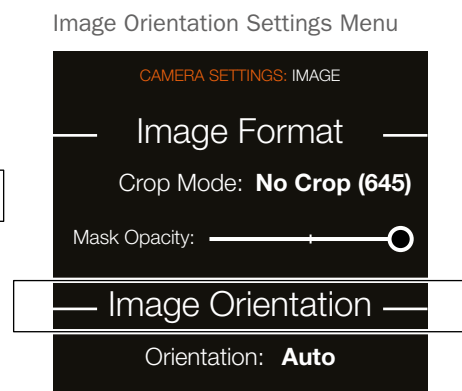
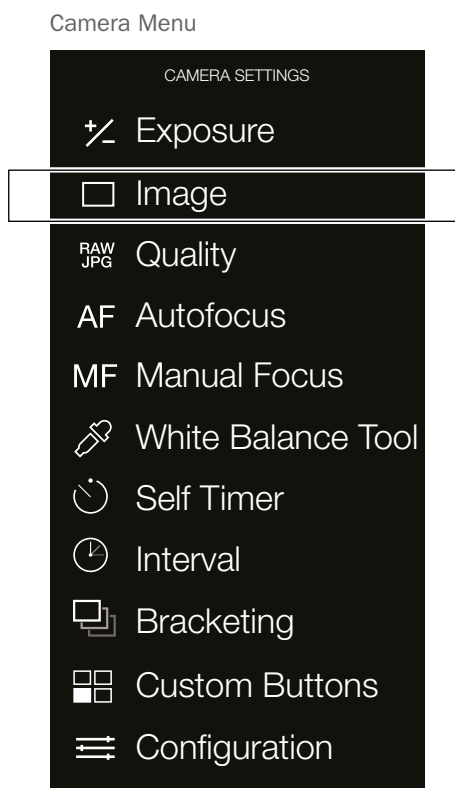

Settings

4.2 IMAGE QUALITY SETTINGS

MAIN MENU > CAMERA SETTINGS >
QUALITY

- 1 Select the Camera icon on the Touch Display.
- 2 The Camera Settings Menu appears.
- 3 Press the Quality Settings Menu.

Swipe right or press Menu / EXIT button to get back to Main Menu.

Image Format

- RAW.
- RAW + JPG.

JPG Quality

- High.
- Normal.

Colour Profile

- sRGB.
- Adobe RGB.

Camera Menu

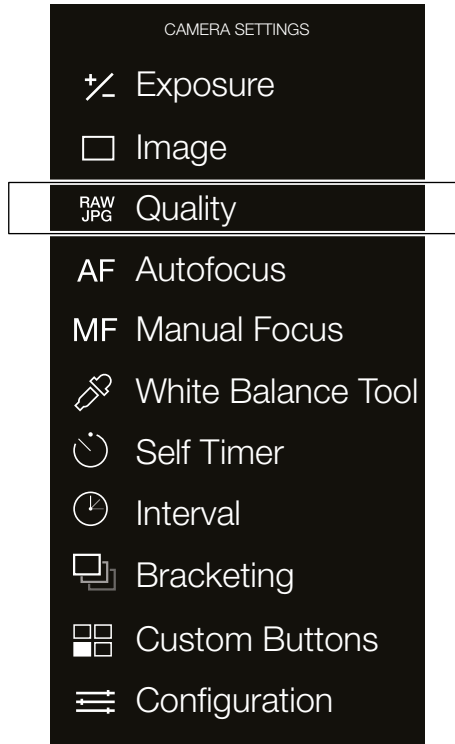

Quality Settings Menu

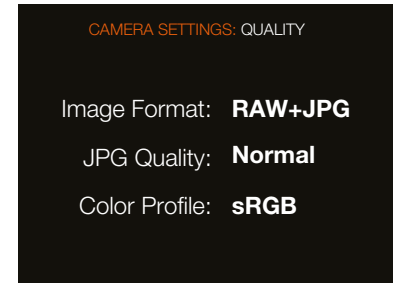

4.3 CAMERA AUTOFOCUS SETTINGS

MAIN MENU > CAMERA SETTINGS > AUTOFOCUS

- 1 Select the Camera icon on the Touch Display.
- 2 The Camera Settings Menu appears.
- 3 Press the Autofocus Settings Menu

Swipe right or press Menu / EXIT button to get back to Main Menu.

AF Point Size

Select the size of the area used for AF measurements. You can choose between:

- 4 mm (35 points)
- 2.8 mm (63 points)
- 2 mm (117 points)

Also see page 69 on how to resize.

Reset Focus Point

Select any of these two settings:

- After Exposure
- Never.

Autofocus Point can be reset to centre position after every exposure. If you need the Autofocus Point to remain in the specific position, select Never. See section Move Autofocus Point for more in-depth information.

Camera Menu

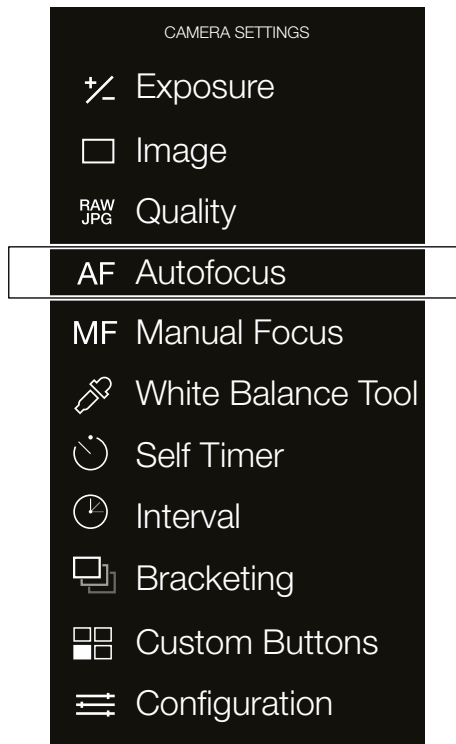

Autofocus Settings Menu

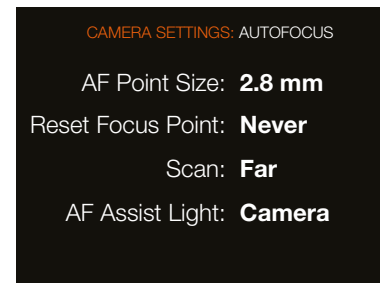

Autofocus Settings Menu

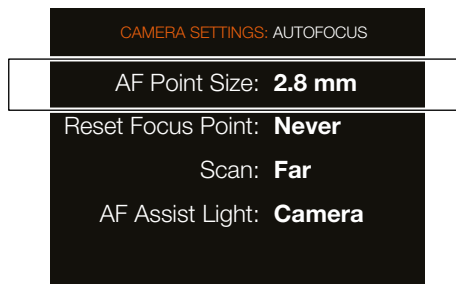

AF Point Size dialogue

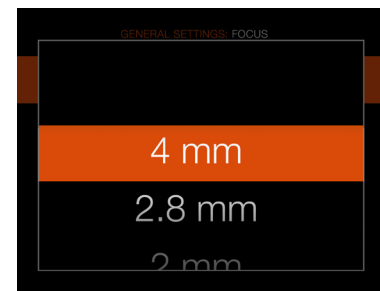

Autofocus Settings Menu

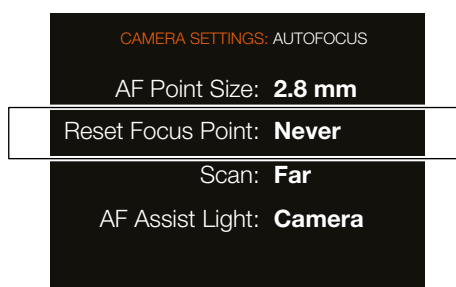

Settings

Scan

If the XCD 120 Macro is used you can choose between:

- Near
- Far
- Full

These settings will limit the focusing range to scan in AF mode.

Autofocus Settings Menu

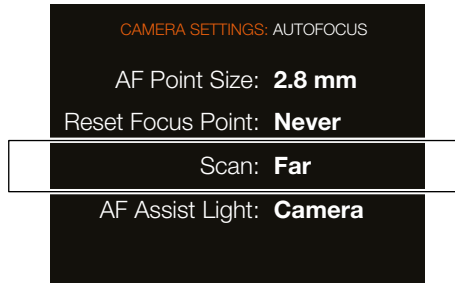

AF Assist Light

Autofocus assist light.

- Camera
- Off

Autofocus Settings Menu

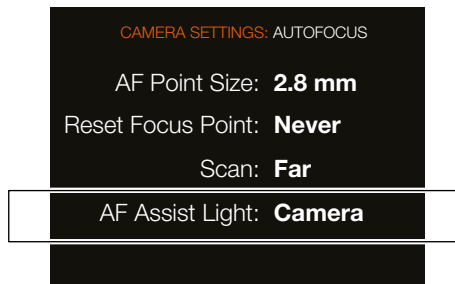

4.4 CAMERA MANUAL FOCUS SETTINGS

MAIN MENU > CAMERA SETTINGS > MANUAL FOCUS

- 1 Select the Camera icon on the Touch Display.
- 2 The Camera Settings Menu appears.
- 3 Press the Manual focus Settings Menu

Swipe right or press Menu / EXIT button to get back to Main Menu.

MF Assist

Manual Focus Assist. Choose between:

- Focus Peaking
- Auto Zoom
- None

Peaking Color

Select Focus Peaking Color.

- Orange
- Yellow
- Cyan
- Magenta

Camera Menu

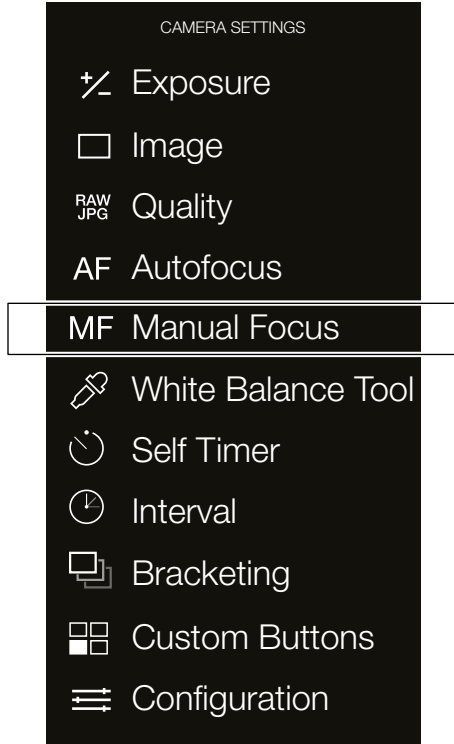

Manual Focus Settings Menu

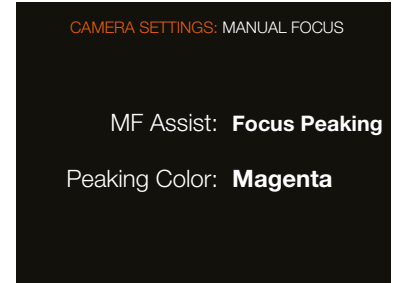

Manual Focus Settings Menu

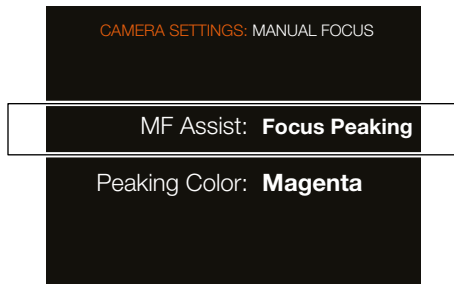

MF Assist dialogue

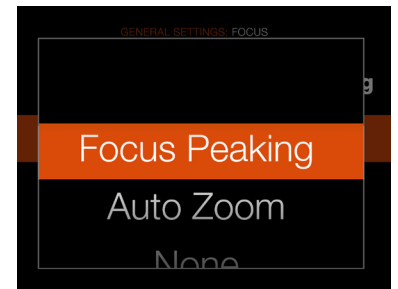

Manual Focus Settings Menu

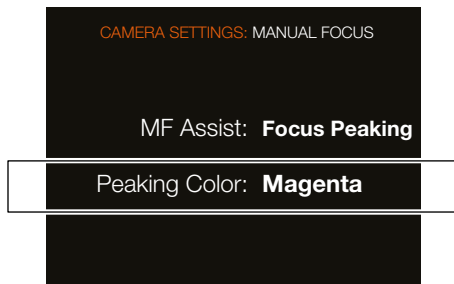

Peaking Color dialogue

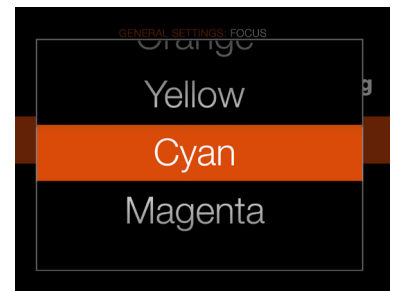

4.5 WHITE BALANCE TOOL

MAIN MENU > CAMERA SETTINGS > WHITE BALANCE TOOL

- 1 Select the Camera icon on the Touch Display.
- 2 The Camera Settings Menu appears.
- 3 Scroll down and press the White Balance Tool Menu.

Swipe right or press Menu / EXIT button to get back to Main Menu.

This function is used to set the colour temperature and tint for a scene where it is difficult to find a matching pre-set value.

- 1 Capture an image from the scene. It should contain something that is neutral in colour. E.g. a Grey Card.
- 2 Click the White Balance Tool menu.
- 3 The last capture is shown together with an overlay. To select another image, turn the front Scroll Wheel or swipe left/right on the display.
- 4 The top row shows the image name and Colour Temperature/Tint values for the location of the movable Colour Picker Tool. The two buttons at the bottom, are used to store the current values for Temperature and Tint, or to exit without changing.
- 5 Find the part of the image that should be neutral. Move the Colour Picker Tool and position the small square over that area, by touching anywhere inside the circle and sliding.
- 6 When you release the finger, Temperature and Tint values are updated in the top row.
- 7 When the correct area has been selected, press SET. To exit without changing, press EXIT.
- 8 The set value for Temperature and Tint will be used for all following exposures. The White Balance Mode is changed to Manual and colour temperature is shown on the Control Screen.

Note!

- The top and bottom parts of the image, cannot be used for white balance setting.
- The colour temperature of the current image does not change.
- If the area used to take a reading, is too bright or too dark, Temp and Tint values will be empty. The same applies if the area is far from colour neutral.

Camera Menu

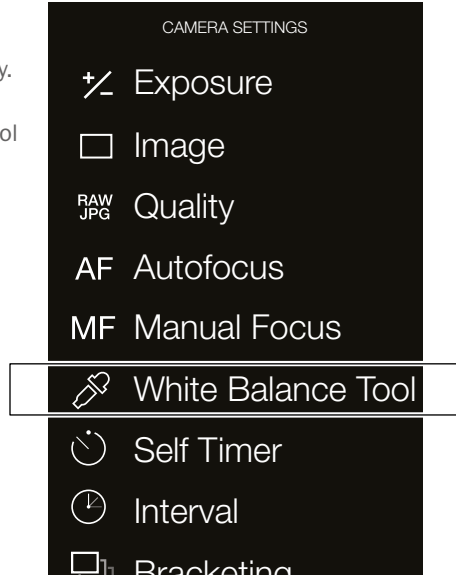

Initial screen when the White Balance Tool is activated.

Colour Picker Tool

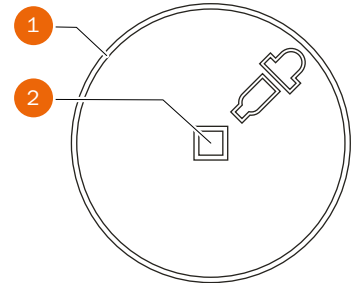

- 1 Active area for moving the tool by touch.
- 2 Active area for calculating Colour Temperature/Tint.

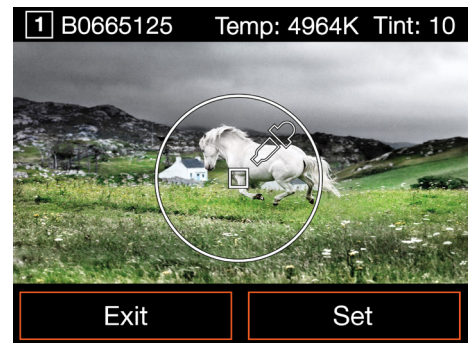

Slide the picker to a neutral area and release. Press SET when ready.

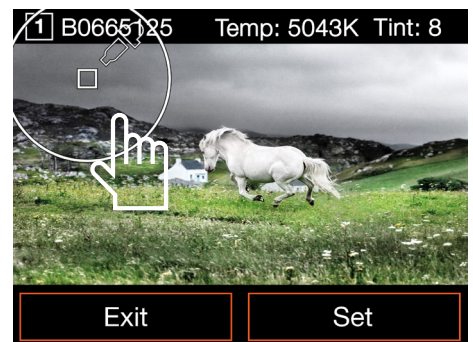

Control Screen shows the new value.

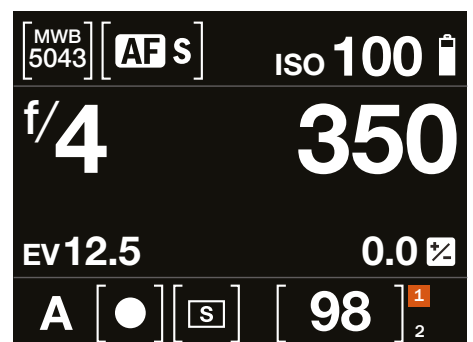

Settings

4.6 CAMERA SELF TIMER SETTINGS

MAIN MENU > CAMERA SETTINGS >
SELF TIMER

- 1 Press the Camera icon on the Touch Display.
- 2 The Camera Settings Menu appears.
- 3 Scroll down and press the Self Timer Settings Menu.

Swipe right or press Menu / EXIT button to get back to Main Menu.

Active

On or Off.

The check box will be marked with a ✓ when Active and the check box will be empty when Self Timer is Off.

Time

2, 3, 4, 5 and so on in steps of one second up to 60 seconds.

When Finished

Exit or Stay.

Controls if Self Timer shall continue to be active after an exposure or not.

Camera Menu

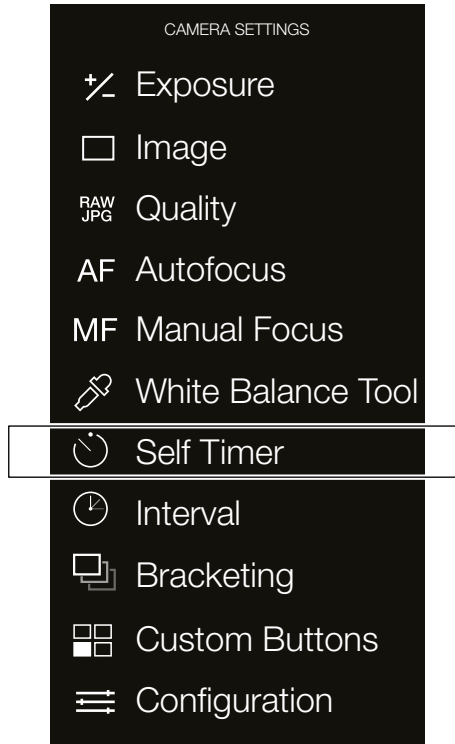

Self Timer Settings Menu

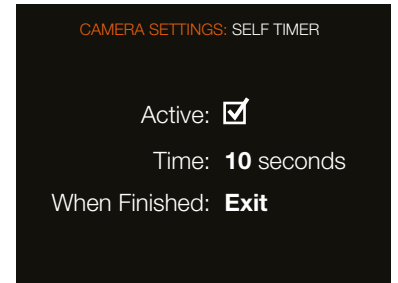

Settings

4.7 CAMERA INTERVAL SETTINGS

MAIN MENU > CAMERA SETTINGS > INTERVAL

- 1 Press the Camera icon on the Touch Display.
- 2 The Camera Settings Menu appears.
- 3 Scroll down and press the Interval Settings Menu.

Swipe right or press Menu / EXIT button to get back to Main Menu.

Interval Settings

Active

The check box will be marked with a ✓ when the Interval function is On.

On or Off.

Time

The time between captures.

2, 3, 4, 5 seconds and so on in steps of one second up to 60 seconds.

Frames

The number of frames in the Interval sequence.

2 to 99 and No Limit.

Initial Delay

The time between triggering and first capture.

None, Interval Time, 2s, 10s or 60s.

When Finished

Controls if Interval shall continue to be active after a completed sequence or not.

Exit or Stay.

Camera Menu

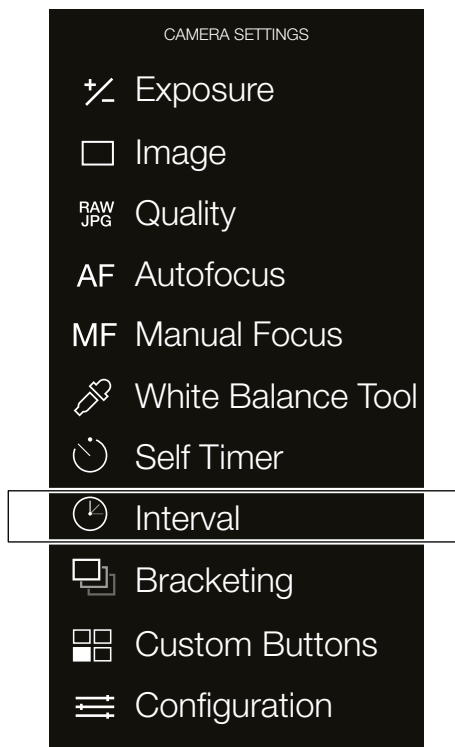

Interval Settings Menu

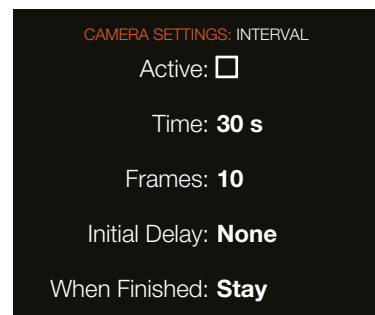

Time Settings Menu

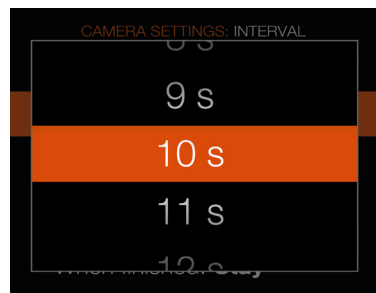

Frames Settings Menu

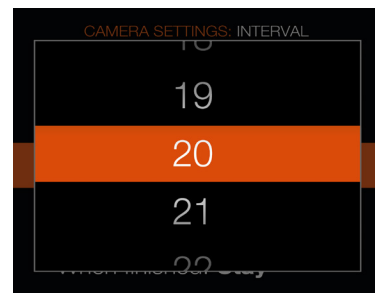

Initial Delay Settings Menu

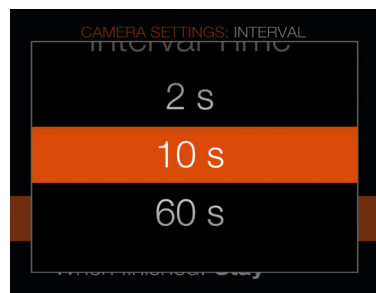

When Finished Settings Menu

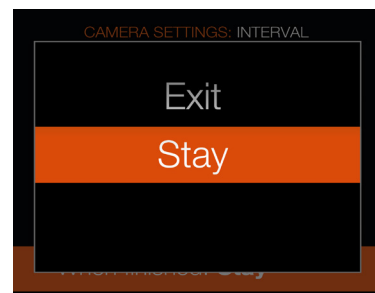

This Chapter continues on next page.

An active and pending Interval Timer, is indicated both on the Control Screen and in Live View.

In the example to the right, a total of 20 images will be captured with an interval time of 12 seconds.

Control Screen

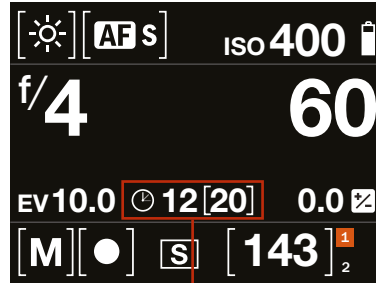

Live View



Interval Timer active. Time in seconds until next exposure. Remaining number of frames.

To start the sequence, simply press the shutter release. If you have set an initial delay to prevent camera shake, the camera will first wait the pre-set number of seconds with a black screen (A), and then start the Interval sequence.

After a capture, the image will show up on the rear screen, together with the Interval information.

To end the sequence before all captures have been made, press Exit (the Star Button).

Note!

Live View is turned off during an Interval sequence.

Note!

The preview can be turned off in the "General Settings - Display - Image Preview - Rear Screen" setting.

Note!

Interval is not supported in Phocus Mobile or when tethered to Phocus. For tethered operation, use the Capture Sequencer function in Phocus.

Note!

During a running Interval Sequence, you can press the Menu Button to activate the Control Screen to check current status.

A

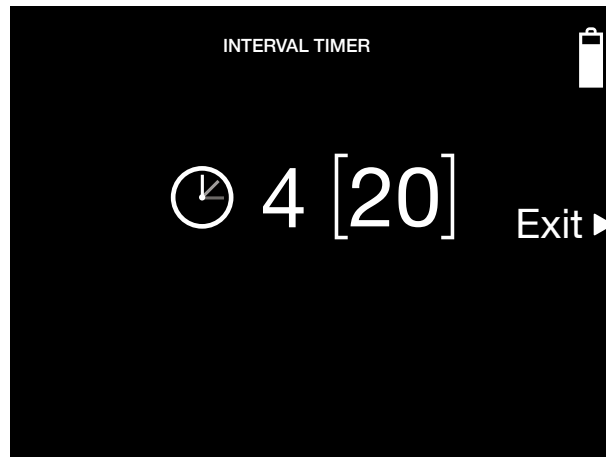

Screen after a capture



Settings

4.8 CAMERA BRACKETING SETTINGS

MAIN MENU > CAMERA SETTINGS > BRACKETING

- 1 Press the Camera icon on the Touch Display.
- 2 The Camera Settings Menu appears.
- 3 Scroll down and press the Bracketing Settings Menu.

Swipe right or press Menu / EXIT button to get back to Main Menu.

Bracketing Settings

Active

The check box will be marked with a \surd when Active and the check box will be empty when Bracketing function is Off.

On or Off.

Amount

The exposure difference between captures.

1/3, 1/2, 1, 2 or 3 Stops.

Frames

The number of frames in the Bracketing sequence.

2, 3, 5, 7 or 9.

Parameter in M

Which parameter to use for Bracketing in Manual mode.

Shutter Speed or Aperture.

Sequence

The sequence to perform Bracketing in.

(0, +, -), (0, -, +), (+, 0, -) or (-, 0, +).

When Finished

Controls if Bracketing shall continue to be active after a completed sequence or not.

Exit or Stay.

Camera Menu

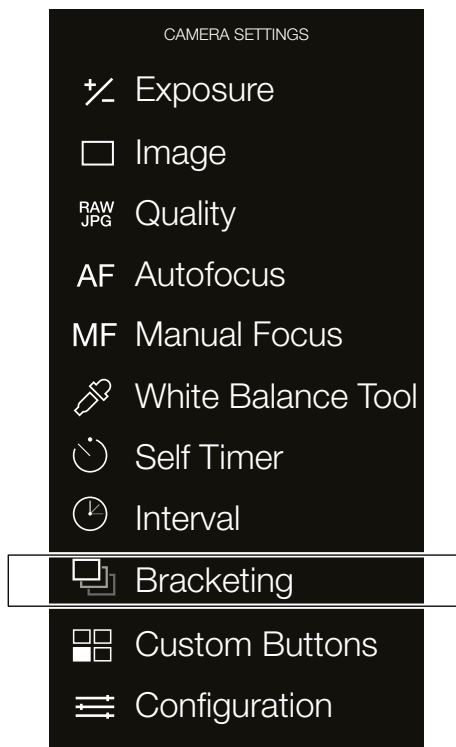

Bracketing Settings Menu

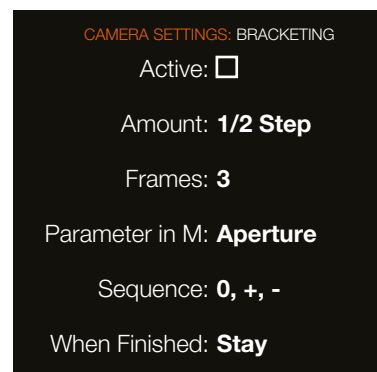

Amount Settings Menu

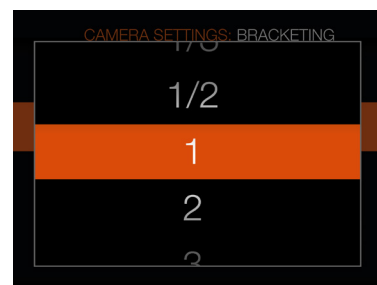

Frames Settings Menu

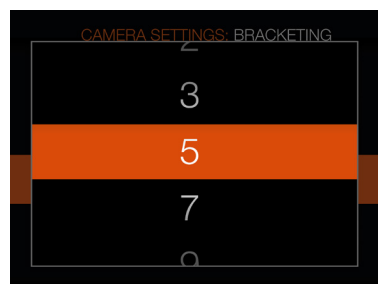

Parameter in M Settings Menu

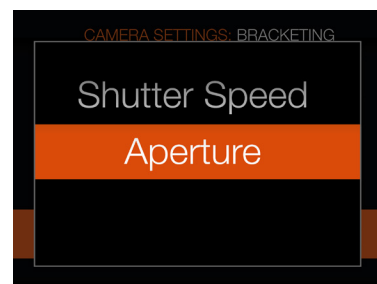

Sequence Settings Menu

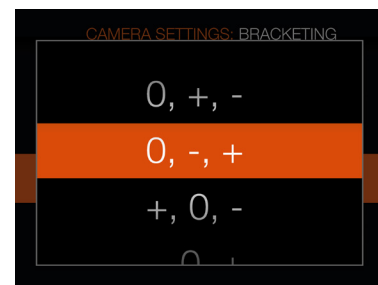

When Finished Settings Menu

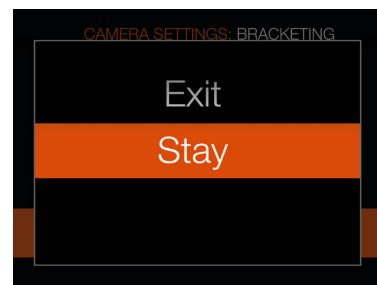

This Chapter continues on next page.

An active and pending Bracketing function, is indicated both on the Control Screen and in Live View.

In the example to the right, the Bracketing sequence will use 3 images.

To start the sequence, simply press the shutter release and all captures will be made automatically.

During the Bracketing sequence, the rear screen and EVF will show an information overlay, as shown to the right.

- 1 Bracketing Icon
- 2 Current capture
- 3 Number of captures in the sequence
- 4 Current exposure adjustment
- 5 For Shutter Speeds longer than 1 second, this indicates the remaining time for the current capture.

To exit from the sequence before it has been completed, press the Cross Button.

After a capture, the last image will show up on the rear screen.

Note!

Bracketing is not supported in Phocus Mobile or when tethered to Phocus. For tethered operation, use the Capture Sequencer function in Phocus.

Note!

Light measurement, focusing and Auto White Balance is performed before first exposure and is applied to all images in the sequence.

Control Screen

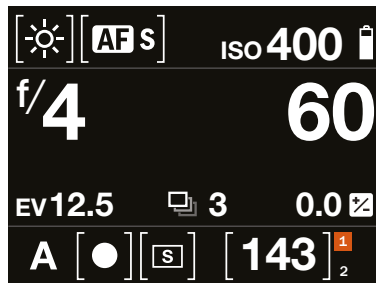

Live View

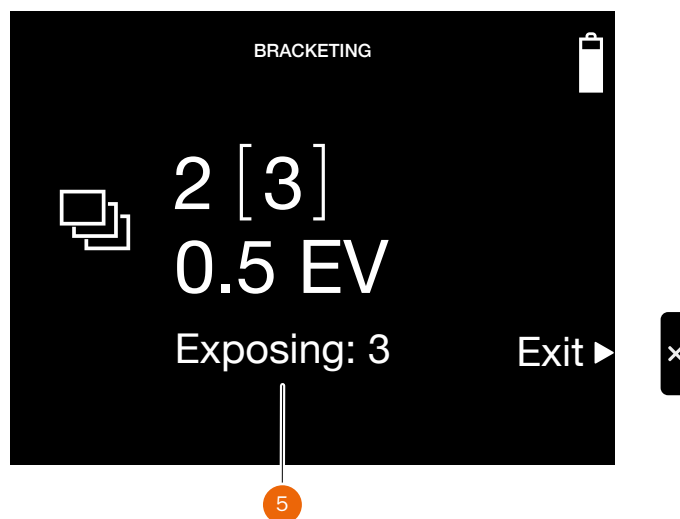
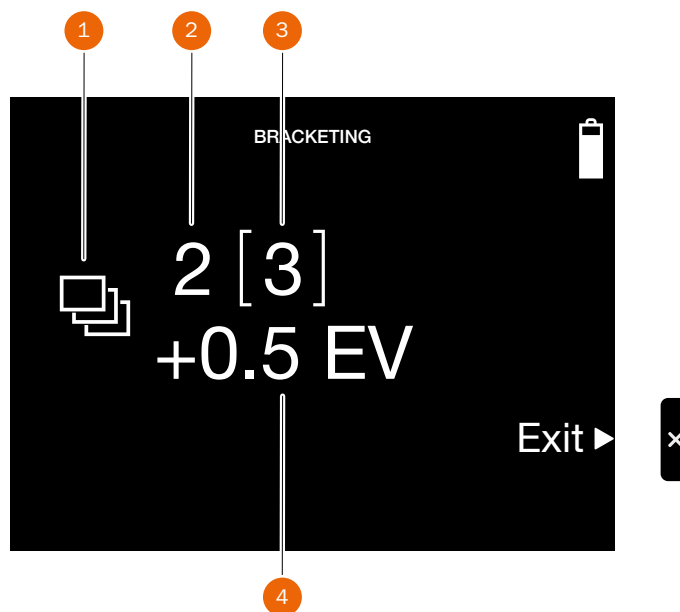
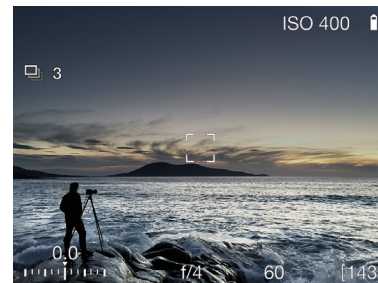

4.9 CAMERA CUSTOM BUTTONS SETTINGS

MAIN MENU > CAMERA SETTINGS > CUSTOM BUTTONS

- 1 Press the Camera icon on the Touch Display.
- 2 The Camera Settings Menu appears.
- 3 Press the Custom Buttons Settings Menu.

Swipe right or press Menu / EXIT button to get back to Main Menu.

In this setting, you can program the following buttons to a different function than the default.

AF/MF (1)

ISO/WB (2)

Stop Down (3)

Programming options:

- Control Screen
- Start Live View
- AF Point Selection
- AF Point Cycle Size
- AF/MF Toggle
- AE-L
- AF-D
- ISO/WB
- ISO
- WB
- Browse Card
- Delete Image
- DOF Preview
- Electronic Shutter On/Off
- Expose
- Zoom In
- Display Off
- Wi-Fi On/Off
- Format Card
- Spirit Level
- Self Timer
- Mark Overexposed On/Off
- Start Video Recording
- Overlay Cycle
- Auto ISO Settings
- Crop Mode Next
- Crop Mode Previous
- White Balance Tool
- Interval
- Bracketing
- None

Camera Menu

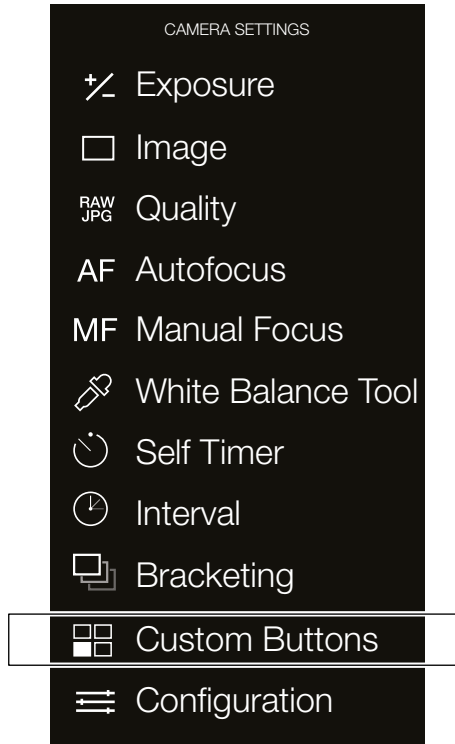

Custom Buttons Settings Menu

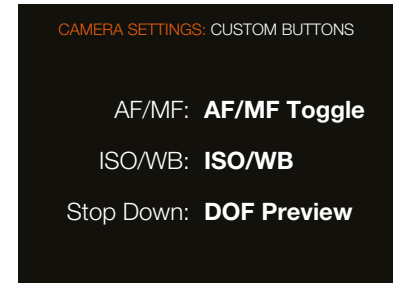

4.10 CAMERA CONFIGURATION SETTINGS

MAIN MENU > CAMERA SETTINGS > CONFIGURATION

- 1 Press the Camera icon on the Touch Display.
- 2 The Camera Settings Menu appears.
- 3 Press the Configuration Settings Menu.

Swipe right or press Menu / EXIT button to get back to Main Menu.

Exposure Quick Adjust

On or Off. When using an auto-exposure mode, a quick exposure adjustment can be made with the rear scroll wheel if set to On.

The check box will be marked with a when On and the check box will be empty when Off.

Auto ISO Limits

Select the range of the Auto ISO Limits when in Auto ISO mode. If you set the Minimum to 800 ISO and Maximum to 6400, then the ISO number will never be set under 800 ISO or over 6400 ISO.

Maximum

200, 400, 800, 1600, 3200, 6400, 12k8, 25k6.

Minimum

100, 200, 400, 800, 1600, 3200, 6400, 12k8.

Note!

If Electronic shutter is used, max ISO is limited to 3200.

Auto ISO / P /

Select the limit for Shutter Speed, where the camera will start to increase ISO in Auto ISO mode. This limit is also used in P and (Full Auto) modes.

This limit can either be set as a function of focal length or as a fixed shutter speed. Default setting is 1/2f.

1/4f, 1/3f, 1/2f, 1/1.5f, 1/f or 2/f (f = focal length) or 1 s to 1/2000 s in 1 Stop increments

Example: If the setting "1/2f" is used with a 45mm lens, the shutter speed limit is 1/90 s.

Camera Menu

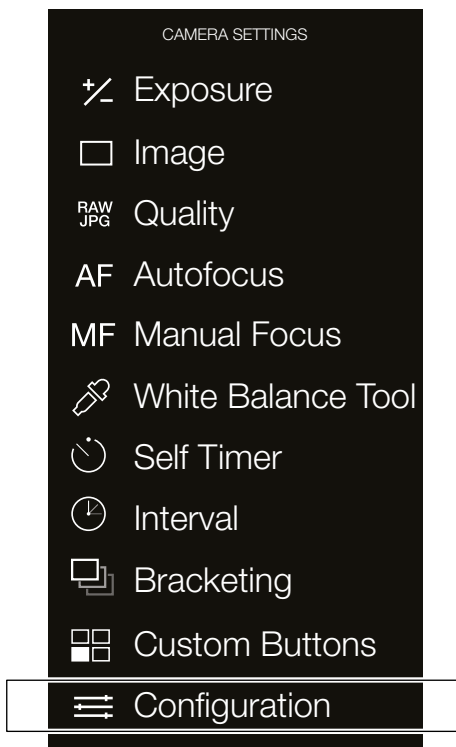

Configuration Settings Menu

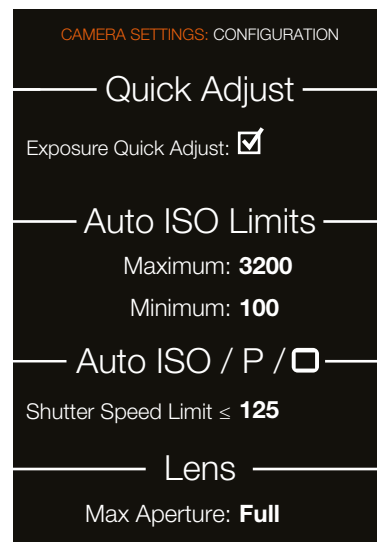

Note!

The Shutter Speed Limit can still be exceeded in some cases. For instance if using A Mode and the Maximum ISO Limit is already reached and there is not enough light, the Shutter Speed Limit will be exceeded as a last resort to get a proper exposure.

This Chapter continues on next page.

Lens

Select if the lens shall use a fully open and round aperture at maximum setting. A round aperture will create a smoother look for the out-of-focus areas. For some lenses, e.g. the XCD 90, this can cause a very slight overexposure.

Normal

Standard setting. Will minimize the risk for internal reflections.

Full.

Selects a fully open round aperture. Only for XCD Lenses.

See illustrations below.

Configuration Settings Menu

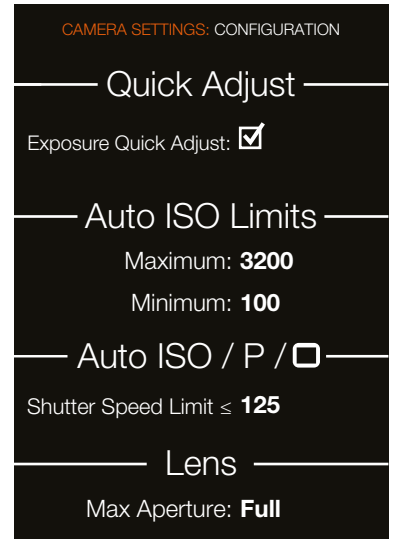

Full image. Magnification of marked area shown to the right:



Resulting image with **Normal** setting



Resulting image with **Full** setting



Normal



Full

4.11 VIDEO SETTINGS MENU

Main Menu

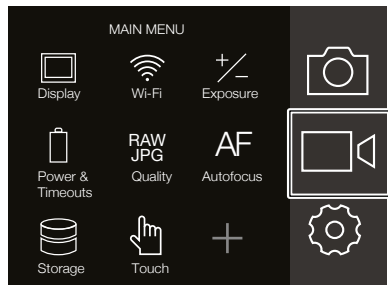

Video icon

Video Settings Menu

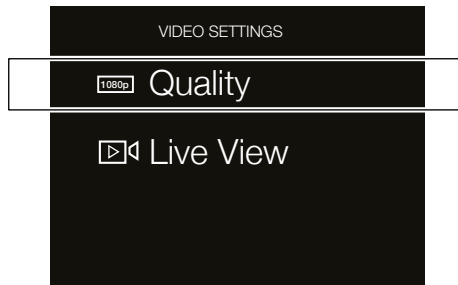

Video Quality Settings

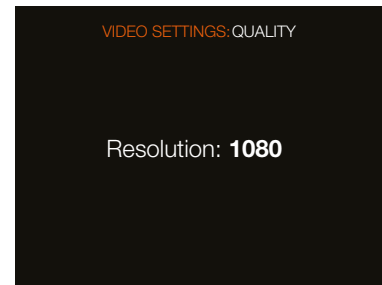

MAIN MENU > VIDEO SETTINGS

- 1 Press the Video icon on the Touch Display.
- 2 The Video Settings Menu appears.
- 3 Select a Video Setting.

Swipe right or press Menu / EXIT button to get back to Main Menu.

Video Settings Menu

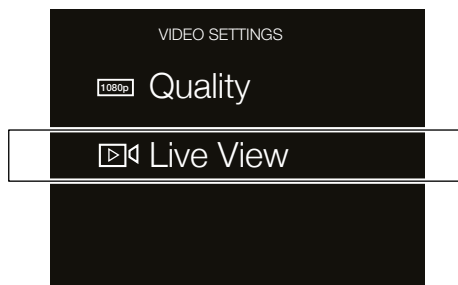

Overlay Settings

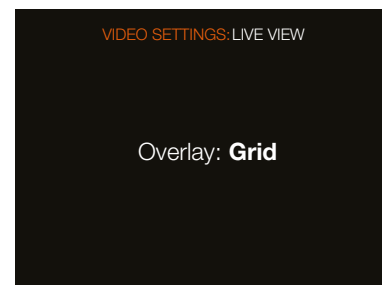

QUALITY

Resolution

Video Quality Resolution Setting
1080p or 720p.

LIVE VIEW

Overlay

Selects the overlay for video Live View screen.

Select from:

- None.
- Grid. Displays a 1/3 grid on the Video Live View screen.

Note!

You can toggle the overlay On or Off by pressing the Display button while in Video Live View.



Video Live View screen with grid enabled



4.12 GENERAL SETTINGS MENU

Main Menu

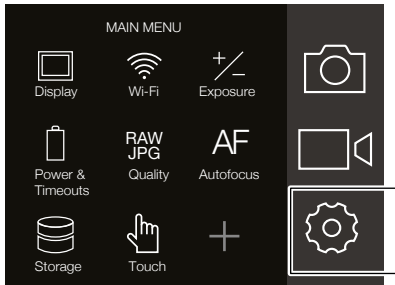

General Settings icon

General Settings Menu

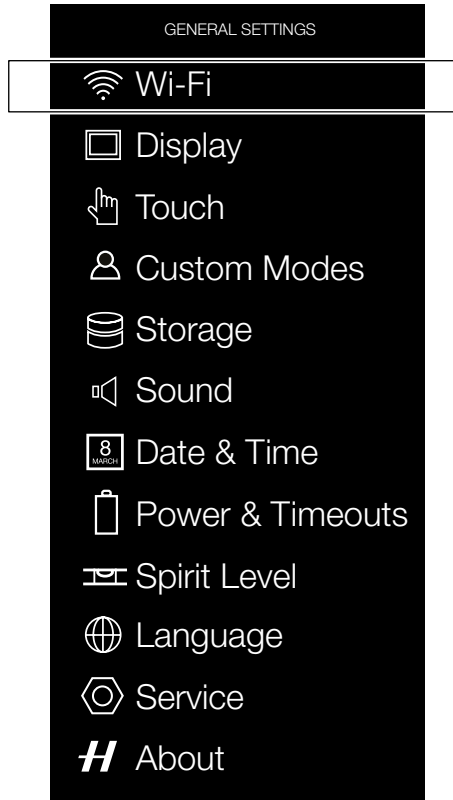

Wi-Fi Settings Menu

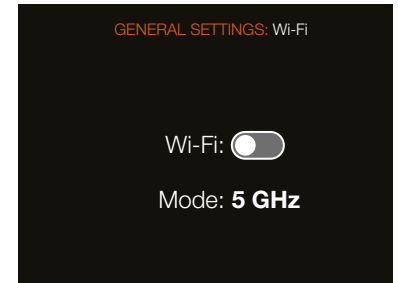

MAIN MENU > GENERAL SETTINGS

- 1 Press the Settings icon on the Touch Display.
- 2 The General Settings Menu appears.

Swipe right or press Menu / EXIT button to get back to Main Menu.

4.13 GENERAL SETTINGS WI-FI

The Wi-Fi mode allows the Hasselblad Phocus Mobile application on an Apple iPhone, iPad or iPod to function in the same way as when a camera is tethered to a computer.

MAIN MENU > GENERAL SETTINGS > WI-FI

- 1 Press MENU.
- 2 Select General Settings in the main menu on the Touch Display.
- 3 Select Wi-Fi.
- 4 Settings:
Wi-Fi: On or Off.
Modes: 2.4 GHz or 5 GHz.

Note!

Some regions do not allow 5 GHz Wi-Fi.

WI-FI MODES

The Wi-Fi function has one mode of operation, Direct Access.

Direct Access is when the camera creates a new Wi-Fi network and an iPhone/iPad/iPod is connected to it.

The name of the network is the camera serial number:

For example: "SQ34000123".

Note!

If Wi-Fi has not been in use for 10 minutes, it will turn off automatically to save power.

4.14 GENERAL SETTINGS DISPLAY

MAIN MENU > GENERAL SETTINGS > DISPLAY

- 1 Press the General Settings icon on the Touch Display.
- 2 The General Settings Menu appears.
- 3 Select Display.

Swipe right or press Menu / EXIT button to get back to Main Menu.

Display Menu Settings

Adjustment of the Display Brightness

Slide Left/Right to adjust the Brightness of the Display. Right increases the Brightness. Left decreases Brightness.

Exposure Simulation

Select A / S / P / On or Off. Select M On or Off. The check box will be marked with a ✓ when On and the check box will be empty when Off.

Live View

Select Zoom Level. Choose between 50% or 100%.

EVF only: when checked, Live View is disabled on the rear LCD. Does not apply to Video Live View.

Image Preview - Rear Screen

Select On / Off. On displays a preview of the capture after every exposure.

The check box will be marked with a ✓ when On and the check box will be empty when Off.

Image Preview - EVF

Select if you want a preview to appear in the EVF after an exposure. Select duration from:

No Preview, 0.5 sec, 1 sec, 2 sec, 4 sec 8 sec and Hold

A half-press on the shutter release will return to Live View.

General Settings Menu

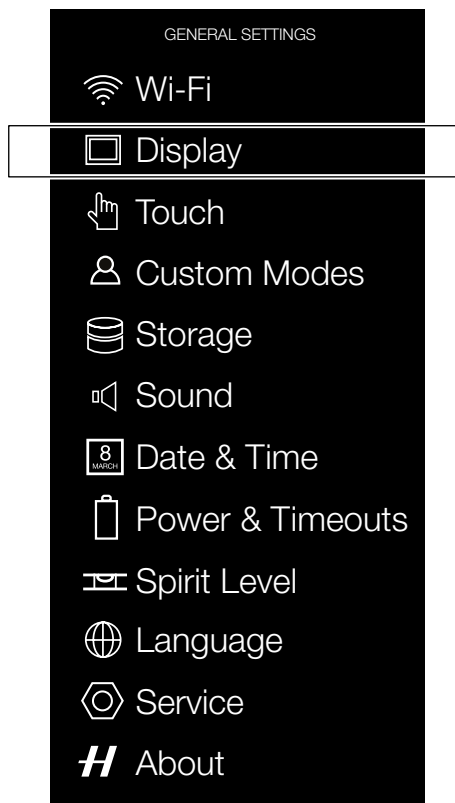

Display Menu

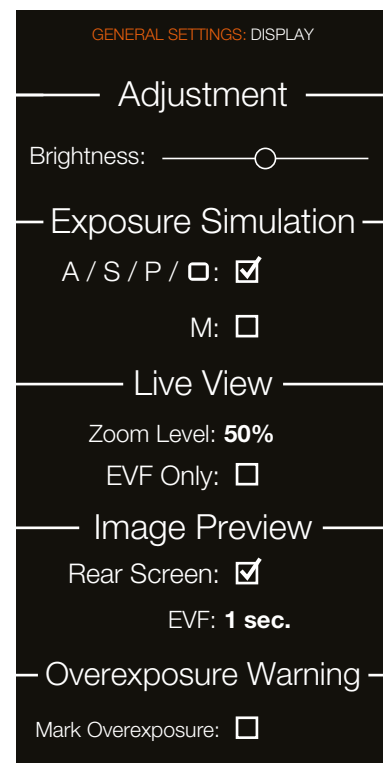

Overexposure Warning

Overexposed areas will be marked with blinking black color if this option is checked.

Exposure Simulation

In Live View mode, the Exposure Simulation displays the effect of the selected exposure settings (Aperture, Shutter and ISO) and how these settings changes the photo. It is an approximation (a close but not exact example) of how the final captured photo will look. If you, for example in Manual exposure mode (M), select a smaller Aperture, the Live View displays a darker image. If you select a more open Aperture, the Live View displays an image that is lighter.

When in the A, S and P exposure modes, you can use Exposure Simulation to see the effect of an exposure adjustment before you capture the photo. As an example, a Quick Adjust of +1.0 steps results in a clearly lighter photo exposure.

Note!

When you use the camera with a flash, the Exposure Simulation will not display a correct result. For example, if you have set the Aperture and Shutter to be adapted to flashlight indoors, normally the Exposure Simulation displays an image that is too dark in the Live View mode. It is advised to turn off Exposure Simulation before you start to take photos with a flash.

Note!

If Exposure Simulation is active and the exposure settings are set to very high overexposure or very low underexposure for the actual light conditions, the Live View displays a very light or very dark image.

General Settings Menu

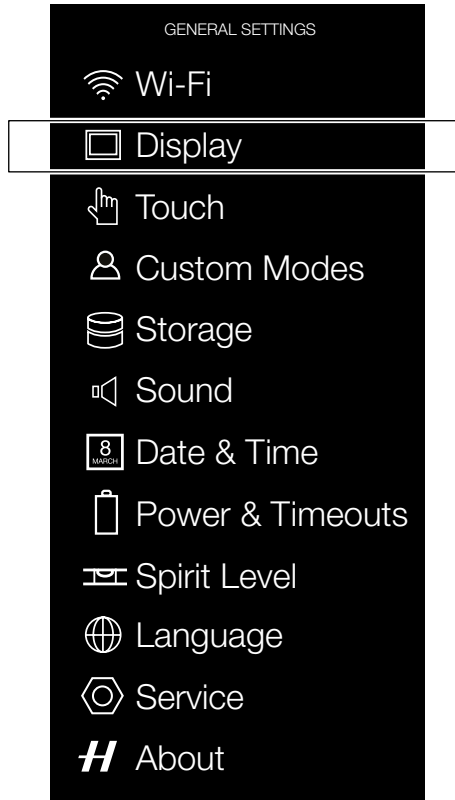

Display Menu

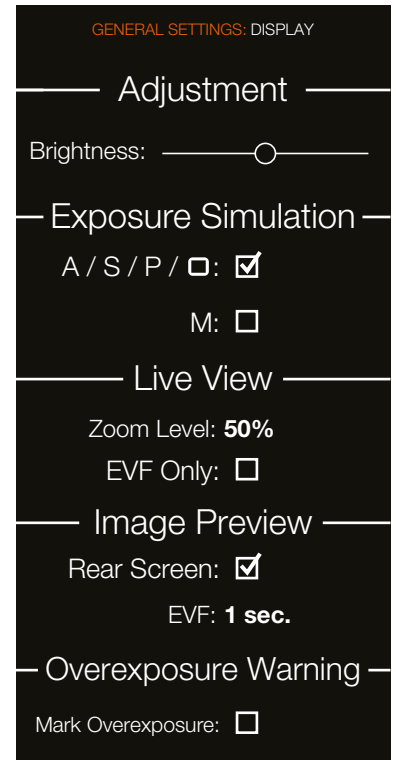

In extreme cases, it results in a completely overexposed white image or a completely underexposed black image. In these cases you can use the balance scale, down to the left in Live View mode, while adjusting the exposure settings, to maintain desired exposure.

Note!

When Autofocus is active and analysing the subject, the Exposure Simulation is deactivated to let the Autofocus system operate in optimal conditions. When the Autofocus process is ready, the Exposure Simulation is automatically activated again.

4.15 GENERAL SETTINGS TOUCH

MAIN MENU > GENERAL SETTINGS > TOUCH

- 1 Press the Settings icon on the Touch Display.
- 2 The General Settings Menu appears.
- 3 Select Touch

Swipe right or press Menu / EXIT button to get back to Main Menu.

Touch Settings

Touchpad for EVF

Select which area of the rear display is used for Touchpad selection of AF point. Choose between:

- Right half of screen (1)
- Left half of screen (2)
- Bottom right (3)
- Top right (4)
- Bottom left (5)
- Top left (6)

See details on page 106.

Move AF Point

When checked, the AF point can be moved by sliding a finger over the area selected in the setting above.

Touchpad for HDMI

Select if rear screen touchpad function shall be used to move AF point when an external HDMI monitor is connected. Please note that touch on the HDMI monitor is not supported.

When zoomed-in in HDMI it is possible to use the Touchpad to pan around in the Live View image.

General Settings Menu

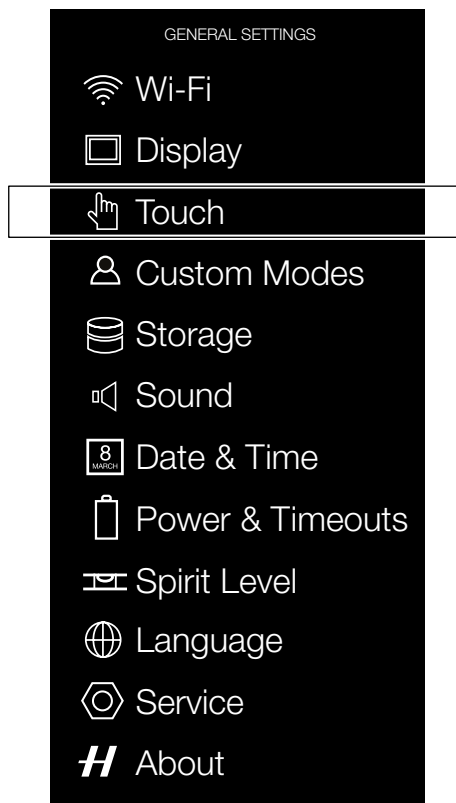

Touch Menu

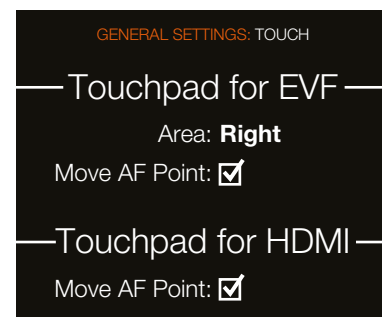

4.16 GENERAL SETTINGS CUSTOM MODES

MAIN MENU > GENERAL SETTINGS >
CUSTOM MODES

- 1 Press the Settings icon on the Touch Display.
- 2 The General Settings Menu appears.
- 3 Select Custom Modes.

Swipe right or press Menu / EXIT button to get back to Main Menu.

Custom Modes Menu Settings

How to save to C1, C2 or C3.

- 1 Select Save to C1 to save to Custom Modes 1.
- 2 A pop up dialogue will display "Save to C1?"
- 3 Select "Save" to save settings to C1 program or select "Exit" to exit without saving settings.

Note!

All previous settings will be overwritten.

General Settings Menu

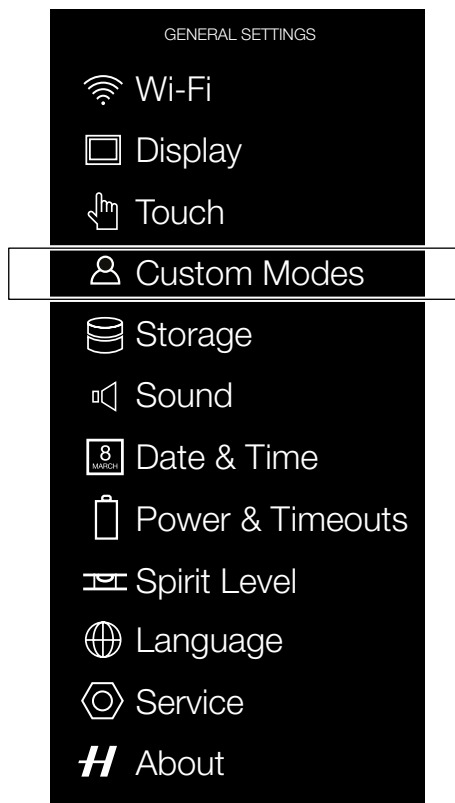

Custom Modes Menu

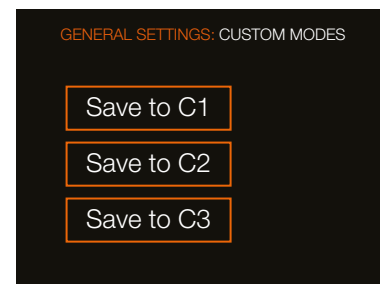

Custom Modes Menu Save to C1

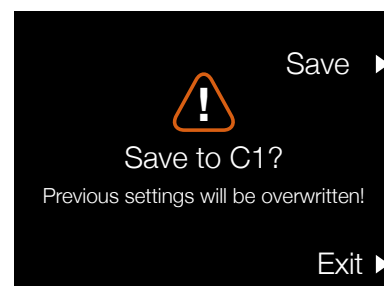

4.17 GENERAL SETTINGS STORAGE

MAIN MENU > GENERAL SETTINGS > STORAGE

- 1 Press the Settings icon on the Touch Display.
- 2 The General Settings Menu appears.
- 3 Press the General Settings Storage icon.

Swipe right or press Menu / EXIT button to get back to Main Menu.

Storage Menu Settings

Format Card

- Format SD 1.
- Format SD 2.

Image Destination

- Primary slot: SD 1 or SD 2.

- Secondary slot usage: None, Overflow or Backup

HOW TO FORMAT A MEMORY CARD

- 1 Select Card to Format, SD 1 or SD 2, on the Storage Menu.
- 2 A new Format Card Dialogue appears.
- 3 To confirm, select Format by pressing the Soft button marked with a square.
- 4 Exit without formatting by pressing the soft button marked with X.

Note!

RAW video is not backed to the SD Card.

General Settings Menu

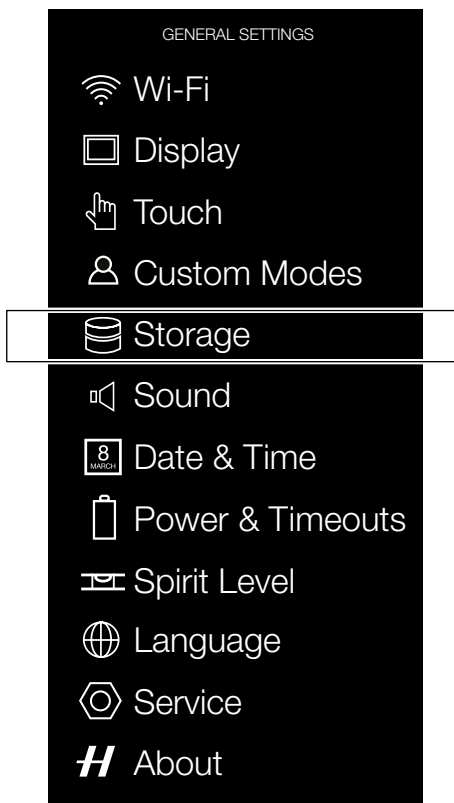

Storage Menu

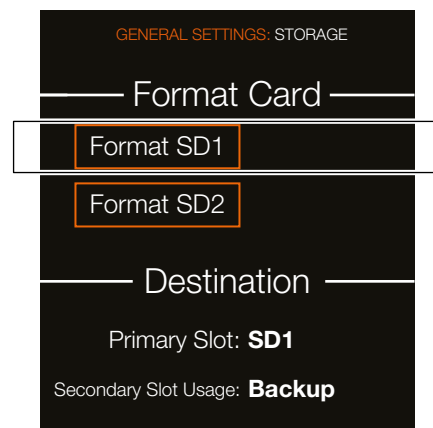

Format Card Dialogue Display

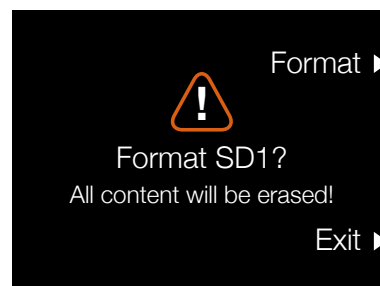

IMAGE AND VIDEO DESTINATION

MAIN MENU > GENERAL SETTINGS > STORAGE > IMAGE DESTINATION

Destination Settings.

- 1 Press the Settings icon on the Touch Display.
- 2 The General Settings Menu appears.
- 3 Press the General Settings Storage icon.
- 4 Select Image Destination.

Swipe right or press Menu / EXIT button to get back to Main Menu.

Image Destination

- Primary slot: SD 1 or SD 2.
- Secondary slot usage:
 - None.
 - Overflow.
 - Backup.

If Overflow is selected, the camera will automatically switch to the secondary card when the primary card is full.

If Backup is selected, the camera will save the image to both cards (RAW and RAW + JPG). Video will also be saved to both cards.

General Settings Menu

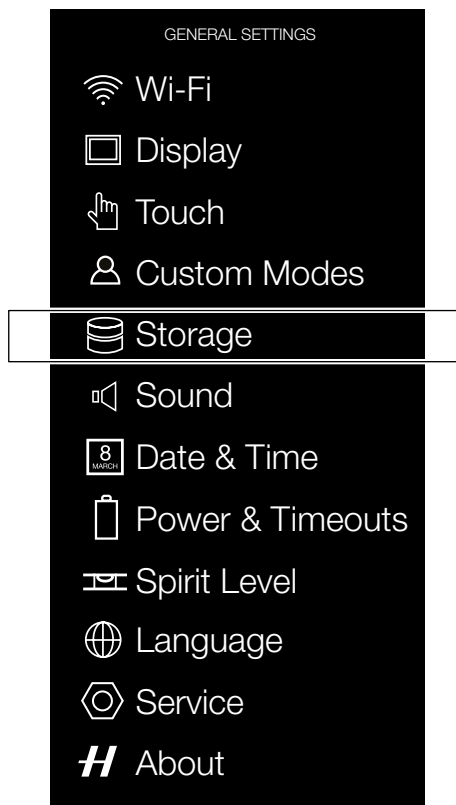

Storage Menu

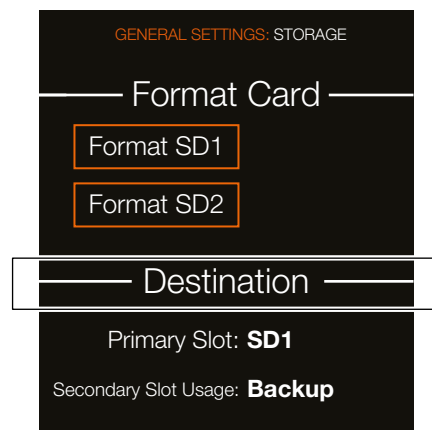

Settings

4.18 GENERAL SETTINGS SOUND

MAIN MENU > GENERAL SETTINGS > SOUND

- 1 Press the General Settings icon on the Touch Display.
- 2 The General Settings Menu appears.
- 3 Scroll down and press the Sound icon.

Swipe right or press Menu / EXIT button to get back to Main Menu.

Sound Settings

Volume

Controls the volume of the sounds.

Off, Low, Medium or High

Key Click

Click sound when a button is pressed.

Select On or Off.

Exposure Warning

The camera will play a sound to indicate over- or underexposure.

Select On or Off.

Ready

A short sound when the camera is ready for a new exposure.

Select On or Off.

AF Result

If AF is successful or not, the camera will play different sounds.

Select On or Off.

Note!

Volume setting only affects sounds in the internal speaker.

General Settings Menu

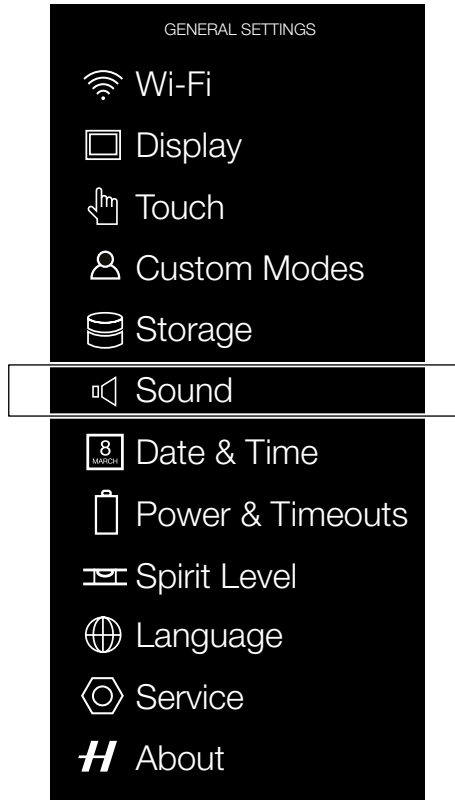

Sound Settings Menu

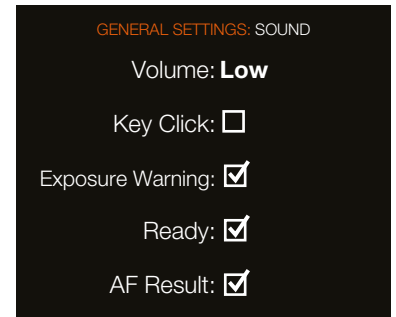

List of available sounds

EVENT	SOUND	EVENT	SOUND
1 image left on media		Off	
5 images left on media		Ready	
Media full		Out-of-range	
AF - focus found		Underexposure	
AF - focus not found		Overexposure	
Error		Self Timer count	
Low Battery		Tethered connect	
Transfer complete		Tethered disconnect	

Notes in the illustration above are not exact, and should be used for reference only.

Settings

4.19 GENERAL SETTINGS DATE AND TIME

MAIN MENU > GENERAL SETTINGS >
DATE AND TIME

- 1 Press the General Settings icon on the Touch Display.
- 2 The General Settings Menu appears.
- 3 Press the Date and Time icon.
- 4 Press the value to change.

Swipe right or press Menu / EXIT button to get back to Main Menu.

Date and Time Menu Settings

Date

Set Date by changing year, month and day using the pop up menus.

Time

Set Time by changing hour and minute using the pop up menus.

General Settings Menu

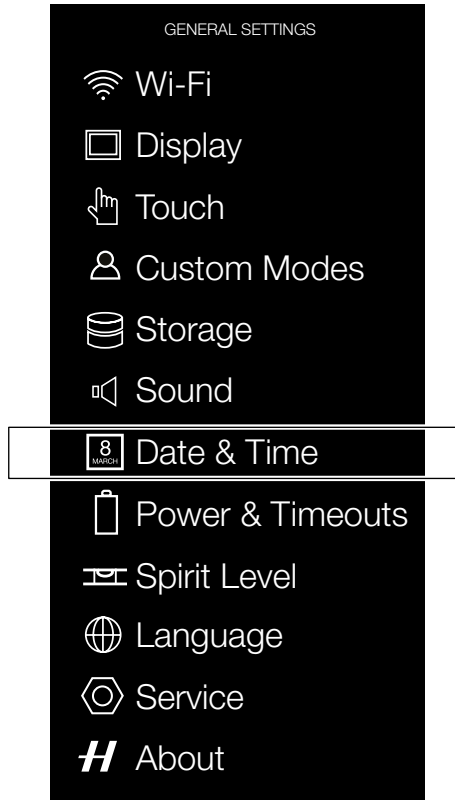

Date and Time Menu

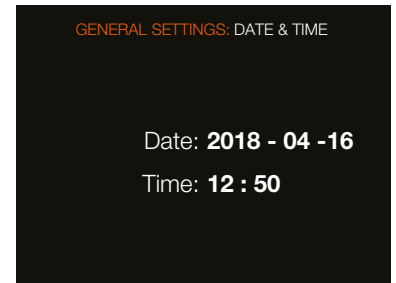

4.20 GENERAL SETTINGS POWER AND TIMEOUTS

MAIN MENU > GENERAL SETTINGS >
POWER AND TIMEOUTS

The X1D Camera can be set to automatically turn off the Touch Display or Power Off after a set amount of seconds to save battery for example.

Change Display or Power Off

- 1 Press the General Settings icon on the Touch Display.
- 2 The General Settings Menu appears.
- 3 Press the General Settings Power and Timeouts icon.
- 4 Adjust the time values by pressing the value and adjust the value in the pop up menus.

Swipe right or press Menu / EXIT button to save and get back to Main Menu.

Display Off

Select Display Off Settings.

- 3, 5, 10, 20, 30, 60 seconds or Never.

Power Off

Select Display Power Off Settings.

- 5, 10, 30 minutes or Never.

Power from USB

When checked, the camera will take power from the USB device. This is indicated by a symbol (A) next to the battery on the Control Screen and on the Live View screen.

Note!

The camera will only be partially powered from USB. A charged camera battery is still required.

Note!

Only power from a USB Host device is supported.

General Settings Menu

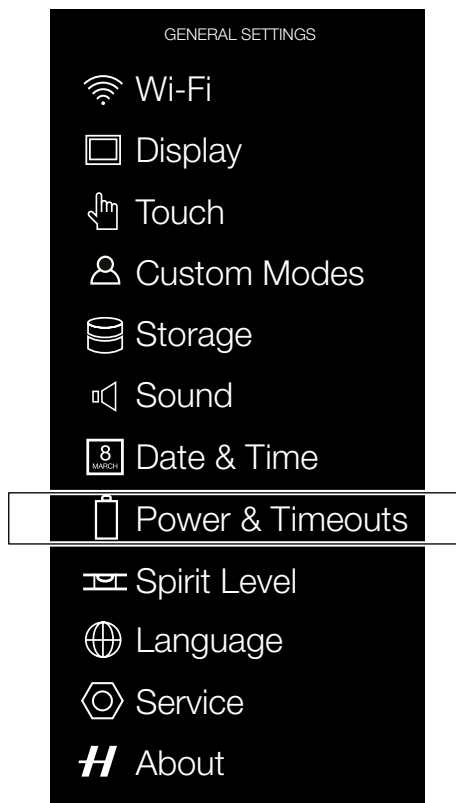

Power and Timeouts Menu

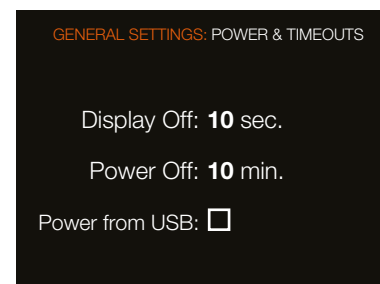

Indication of active USB power.



4.21 GENERAL SETTINGS SPIRIT LEVEL

MAIN MENU > GENERAL SETTINGS > SPIRIT LEVEL

The camera is equipped with an accelerometer. The accelerometer is used to measure the tilt of the camera relative to the horizontal axis (A) and vertical axis (B).

How to align Camera with Spirit Level

- 1 Press the General Settings icon on the Touch Display.
- 2 The General Settings Menu appears.
- 3 Press the General Settings Spirit Level icon.
- 4 Adjust the tilt of the camera left/right and up/down until the white filled circle is in the centre and turns green.

Swipe right or press Menu / EXIT button to get back to Main Menu.

General Settings Menu

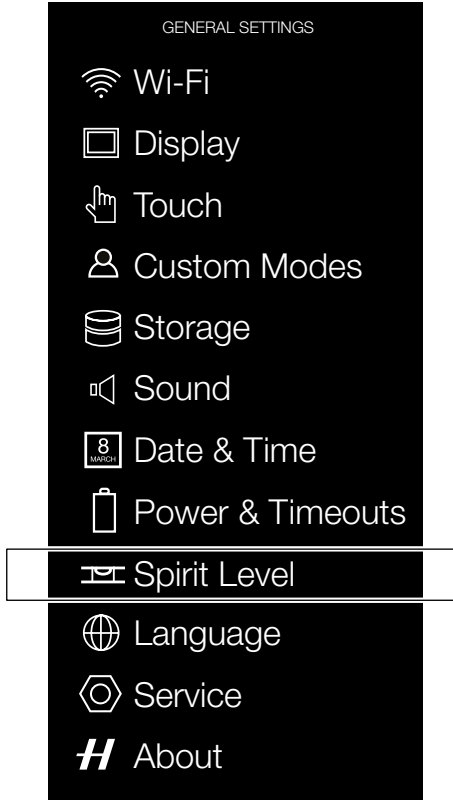

Spirit Level when camera is aligned

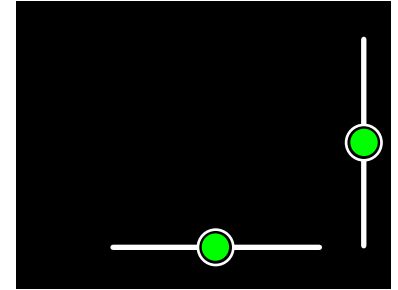

Spirit Level when camera is tilted a little to the right and more down.

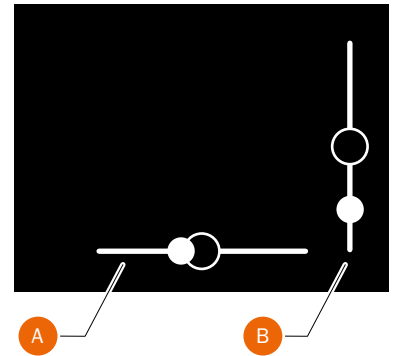

Camera tilted to the left.



Camera aligned horizontally and vertically.



Camera tilted to the right.



Camera tilted up.



Camera aligned vertically.



Camera tilted down.



CALIBRATE SPIRIT LEVEL

MAIN MENU > GENERAL SETTINGS > SPIRIT LEVEL

The Spirit Level can be set to Factory or User mode. In User mode, the Spirit Level can be calibrated by the user. In Factory mode, the calibration from the Factory is used.

 Factory mode with Factory settings.

 User mode with User settings.

How to calibrate Spirit Level

- 1 Press the General Settings icon on the Main Menu display.
- 2 The General Settings Menu appears.
- 3 Press the General Settings Spirit Level icon.
- 4 Press the icon in the top left corner (A).
- 5 The Spirit Level dialogue appears.
- 6 Align the camera carefully both horizontally and vertically.
- 7 Press Calibrate (B).
- 8 The two white circles are now moved to their centre position. When in their centre position, they turn green.

Swipe right or press Menu / EXIT button to get back to Main Menu.

How to reset Spirit Level to Factory calibration

- 1 Press the General Settings icon on the Main Menu display.
- 2 The General Settings Menu appears.
- 3 Press the General Settings Spirit Level icon.
- 4 Press the icon in the top left corner (A).
- 5 The Spirit Level dialogue appears.
- 6 Press the Factory settings icon (C).
- 7 The Factory settings icon (D) is now displayed and the Spirit Level is reset to Factory calibration settings.

Swipe right or press Menu / EXIT button to get back to Main Menu.

General Settings Menu

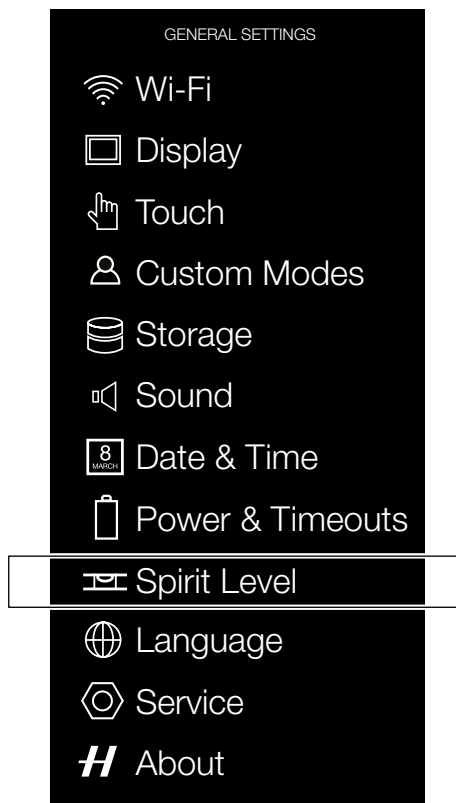

Spirit Level when camera is aligned

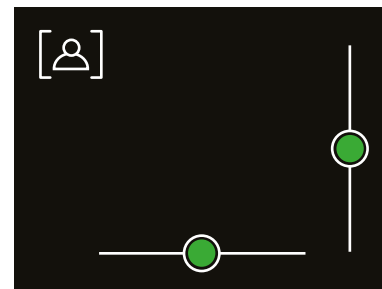

Spirit Level when camera is tilted a little to the right and more down.

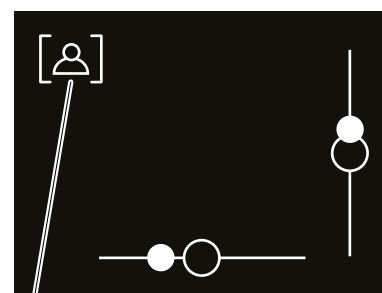

A

Spirit Level when calibrated by user.

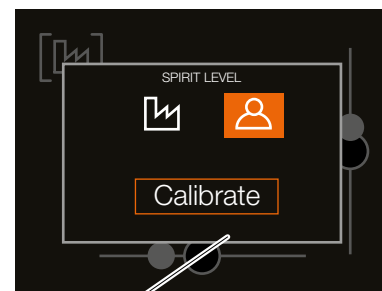
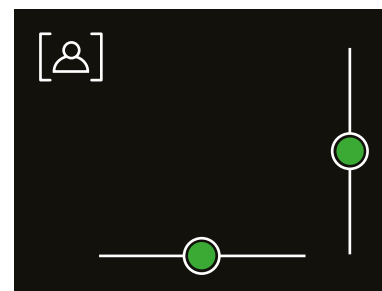

B

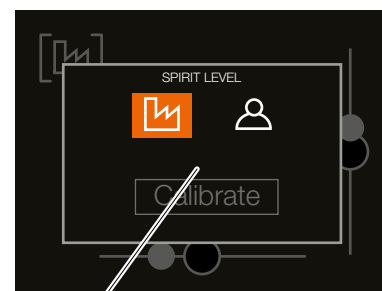

C

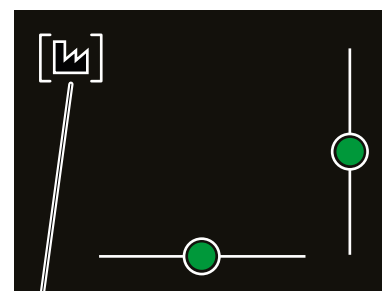

D

4.22 GENERAL SETTINGS LANGUAGE

MAIN MENU > GENERAL SETTINGS > LANGUAGE

- 1 Press the General Settings icon on the Touch Display.
- 2 The General Settings Menu appears.
- 3 Press the General Settings Language icon.

Swipe right or press Menu / EXIT button to Save and get back to Main Menu.

Available Languages:

English
Spanish
French
German
Italian
Swedish
Russian
Chinese
Japanese
Korean

General Settings Menu

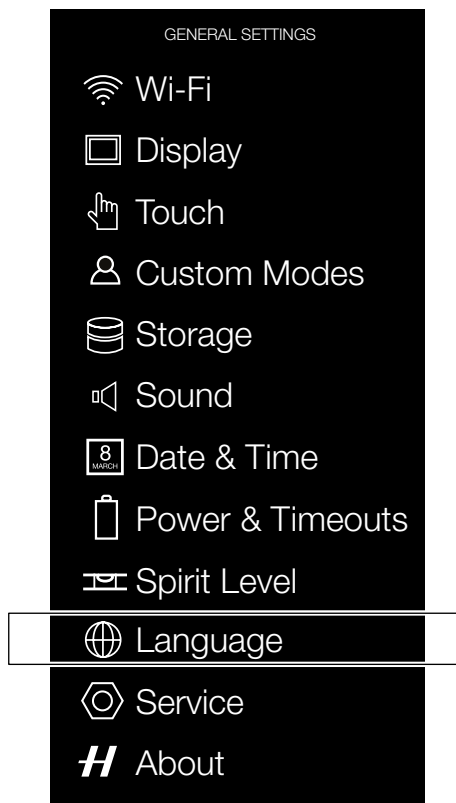

Language Menu

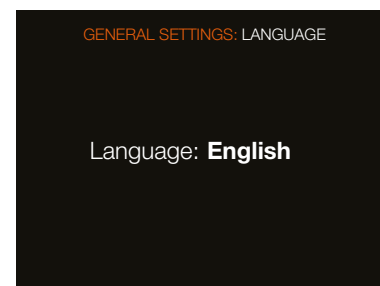

How to change Language

- 1 Press MENU button on the Touch Display.
- 2 Navigate to General Settings.
- 3 Navigate to Language.
- 4 Select Language.
- 5 Close the pop up Menu by a click outside the pop up.

Note!

If the Camera has been set to a language you do not understand, see chapter Troubleshooting for a solution.

4.23 GENERAL SETTINGS SERVICE

MAIN MENU > GENERAL SETTINGS > SERVICE

- 1 Press the General Settings icon on the Touch Display.
- 2 The General Settings Menu appears.
- 3 Press the General Settings Service icon.

Swipe right or press Menu / EXIT button to get back to Main Menu.

Service Menu Settings

Firmware Update

Check For Update.

Log Data

Press Save to Log Data for Service.

Default Settings

Reset all Settings.

File Counter

Reset.

General Settings Menu

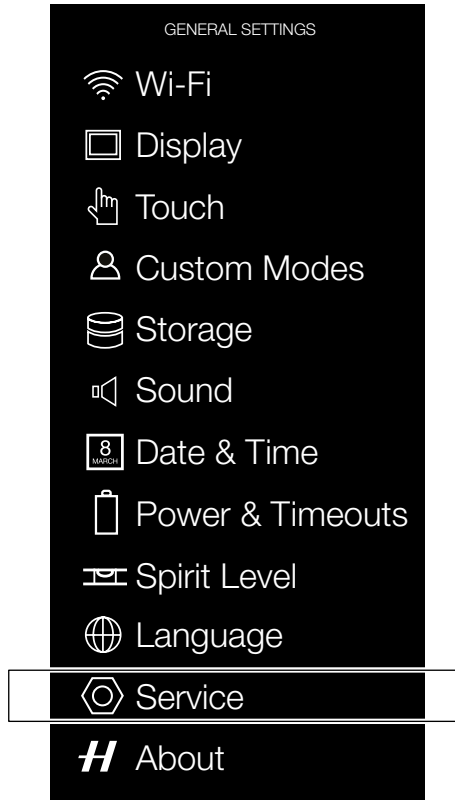

Service Menu

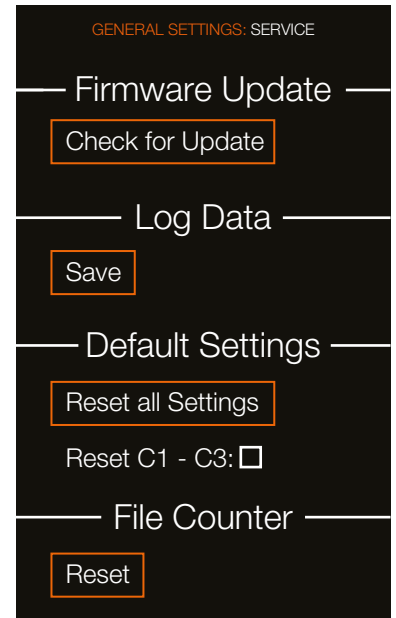

4.24 UPDATE X1D CAMERA FIRMWARE

MAIN MENU > GENERAL SETTINGS >
SERVICE > CHECK FOR UPDATE

- 1 Press the Settings icon on the Touch Display.
- 2 The General Settings Menu appears.
- 3 Press the Service Menu.
- 4 Press the Check for Update button.
- 5 The camera will now check the inserted card/cards for update files.

Swipe right or press Menu / EXIT button to get back to Main Menu.

General Settings Menu

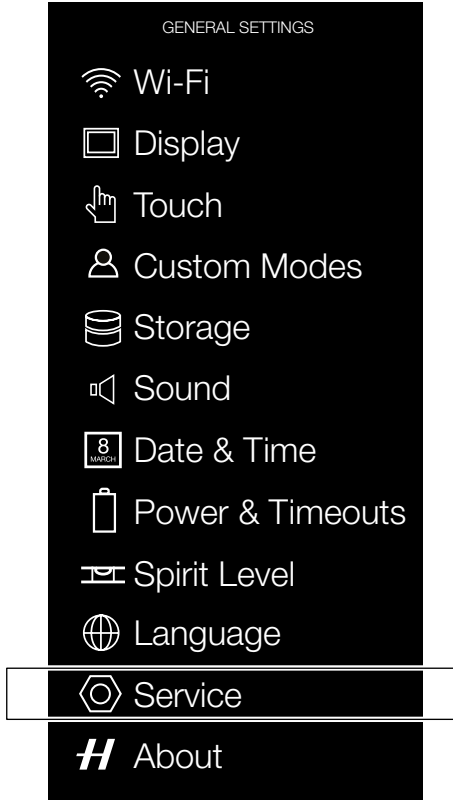

Service Menu

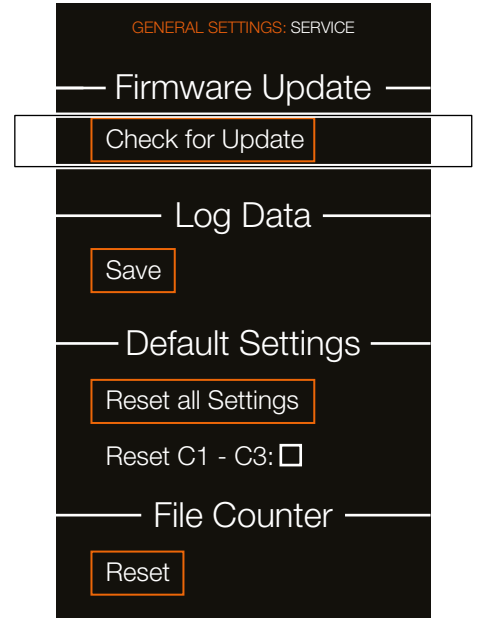

UPDATE X1D FIRMWARE PROCEDURE

- 1 Download the latest X1D Firmware from www.hasselblad.com.
- 2 Save the Firmware file to a SD Card.
- 3 Insert the SD Card in the X1D Camera.
- 4 Select Settings from the Main Menu.
- 5 Select Service / Firmware Update / Check for Update.
- 6 Make sure the Firmware File Name and Number corresponds to the latest Firmware File you have downloaded.
- 7 Select Update.
- 8 Select Update in the Update Dialogue to start the X1D Firmware Update.
- 9 During the update the text "Update in progress" is displayed on the X1D Camera Display.
- 10 Do not turn off the X1D Camera during the Update Progress.
- 11 The Update will take several minutes.
- 12 When the Update is finished this text will be displayed: "Update Finished. Please remove and reinsert battery!".
- 13 Remove and reinsert the battery.
- 14 Start the X1D Camera.
- 15 The new X1D Firmware is now installed!

Check for Update

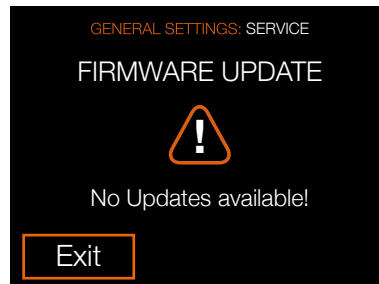

Firmware Update dialogue when no Firmware Updates are available.

Firmware Update

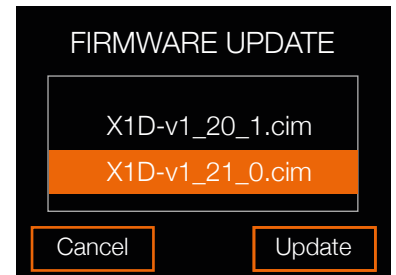

Firmware Update dialogue when two Firmware Updates are available.

Update Dialogue

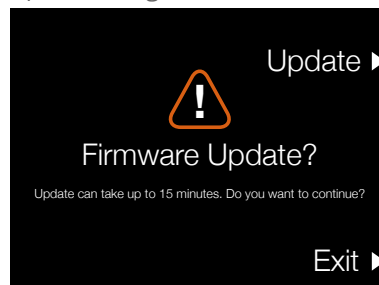

Firmware Update Confirm dialogue to continue Update process. The update can take up to 15 minutes. Select Update or Exit.

4.25 UPDATE X1D LENS FIRMWARE

MAIN MENU > GENERAL SETTINGS >
SERVICE > CHECK FOR UPDATE

- 1 Press the Settings icon on the Touch Display.
- 2 The General Settings Menu appears.
- 3 Press the Service Menu.
- 4 Press the Check for Update button.
- 5 The camera will now check the inserted card/cards for update files.

Swipe right or press Menu / EXIT button to get back to Main Menu.

UPDATE LENS FIRMWARE PROCEDURE

- 1 Attach the lens to the X1D Camera.
- 2 Download the latest XCD Lens Firmware from www.hasselblad.com.
- 3 Save the Firmware file to a SD Card.
- 4 Insert the SD Card in the X1D Camera.
- 5 Select Settings from the Main Menu.
- 6 Select Service / Firmware Update / Check for Update.
- 7 Make sure the Firmware File Name and Number corresponds to the latest Firmware File you have downloaded.
- 8 Select Update.
- 9 Select Update in the Update Dialogue to start the X1D Lens Firmware Update.
- 10 During the update the text "Update in progress" is displayed on the X1D Camera Display.
- 11 Do not turn off the X1D Camera during the Update Progress.
- 12 The Update will take several minutes.
- 13 When the Update is finished this text will be displayed:
"Update is completed!".
- 14 The new Lens Firmware is now installed!

General Settings Menu

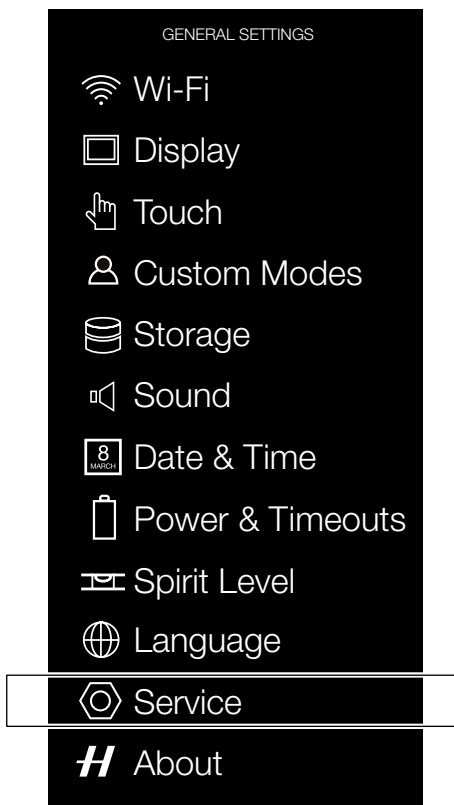

Service Menu

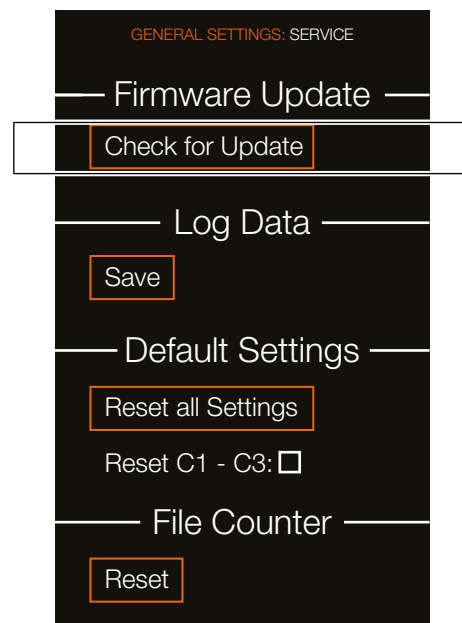

Check for Update

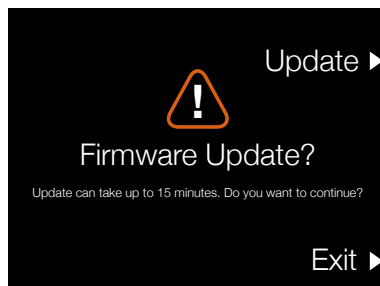

Lens Firmware Update dialogue when no Lens Firmware Updates are available.

Firmware Update

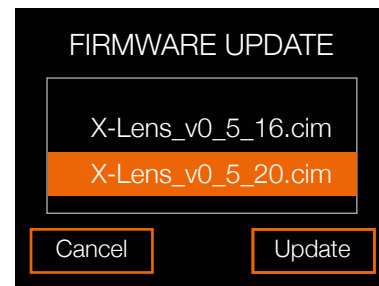

Firmware Update dialogue when two Lens Firmware Updates are available.

Update Dialogue

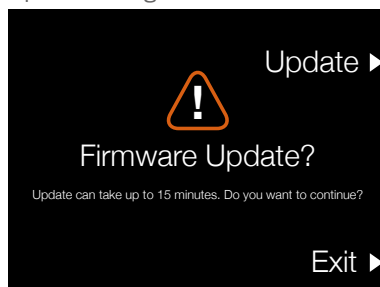

Firmware Update Confirm dialogue to continue Update process. The update can take up to 15 minutes. Select Update or Exit.

4.26 GENERAL SETTINGS SAVE LOG DATA

MAIN MENU > GENERAL SETTINGS >
SERVICE > LOG DATA

- 1 Press the General Settings icon on the Touch Display.
- 2 The General Settings Menu appears.
- 3 Press the General Settings Service icon.
- 4 Select Save under Log Data.

Swipe right or press Menu / EXIT button to get back to Main Menu.

How to save Log Data:

- 1 Press MENU.
- 2 Navigate to General Settings.
- 3 Navigate to Service.
- 4 Navigate to Log Data.
- 5 Press the Save button.
- 6 Save Log Data saves a log file on the SD 1 card or SD 2 card.
- 7 Press MENU button to exit.

General Settings Menu

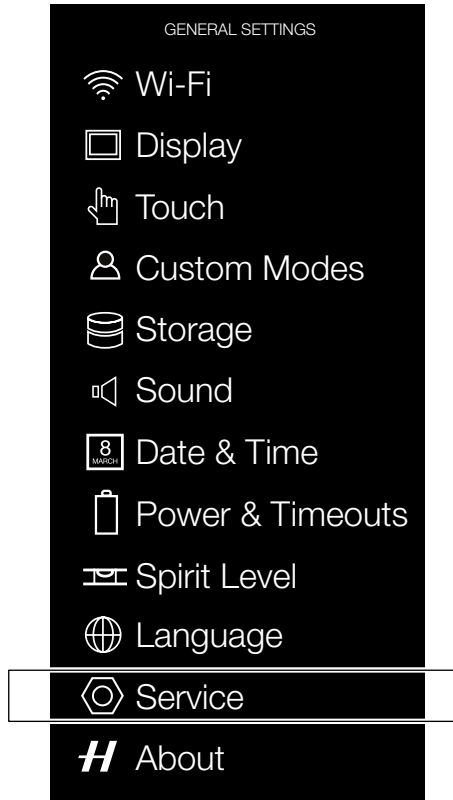

Service Menu

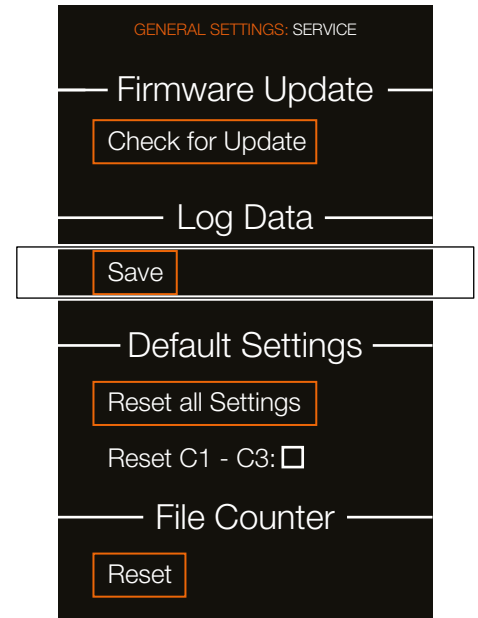

4.27 GENERAL SETTINGS DEFAULT SETTINGS

MAIN MENU > GENERAL SETTINGS >
SERVICE > DEFAULT SETTINGS

- 1 Press the General Settings icon on the Touch Display.
- 2 The General Settings Menu appears.
- 3 Press the General Settings Service icon.
- 4 Select Reset All Settings under Default Settings.

Swipe right or press Menu / EXIT button to get back to Main Menu.

General Settings Menu

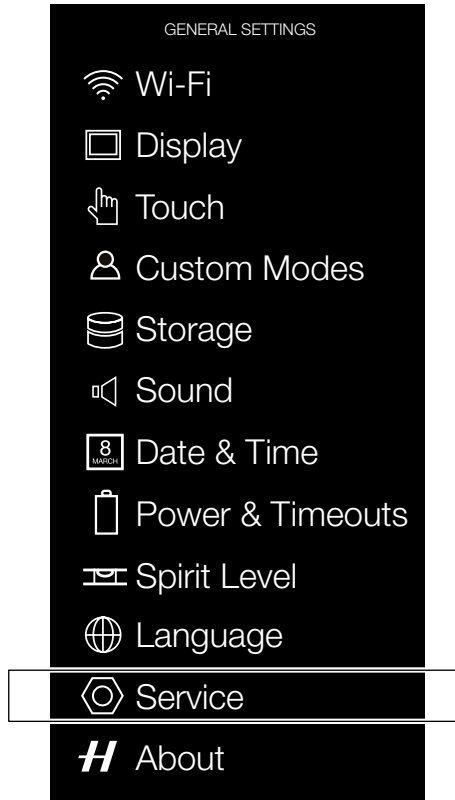

Service Menu

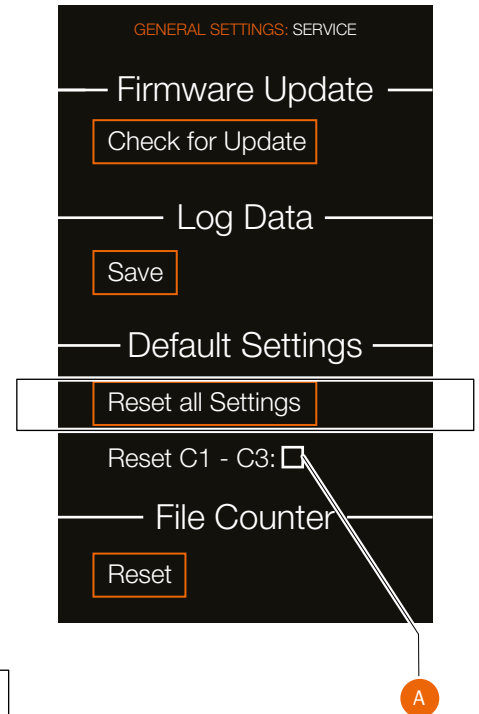

How to reset all Settings to Default Settings:

- 1 Press MENU.
- 2 Navigate to General Settings.
- 3 Navigate to Service.
- 4 Press "Reset All Settings".
- 5 A "Reset All Settings" confirmation dialogue appears.
- 6 If you also want Custom Modes C1, C2 and C3 to be reset, check the box (A) before pressing "Reset Settings".
- 7 Select Reset to Reset all Settings.
- 8 After confirmation, all settings will be reset to default values.

Note!

Select Exit to exit without resetting.

Reset All Settings Dialogue. C1 - C3 are selected to be reset.

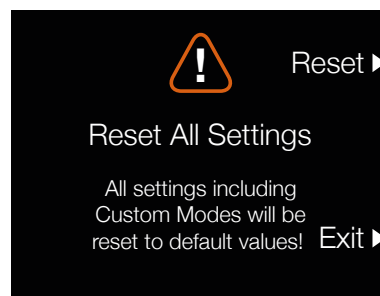

Reset All Settings Dialogue. C1 - C3 are not selected to be reset.

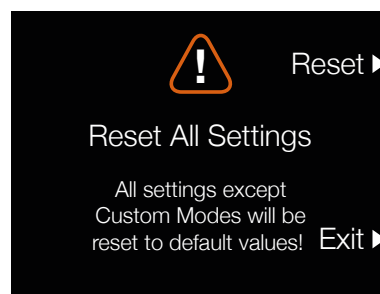

4.28 GENERAL SETTINGS FILE COUNTER

MAIN MENU > GENERAL SETTINGS >
SERVICE > FILE COUNTER

- 1 Press the General Settings icon on the Touch Display.
- 2 The General Settings Menu appears.
- 3 Press the Service Menu.
- 4 Select Reset under File Counter.

Swipe right or press Menu / EXIT button to get back to Main Menu.

General Settings Menu

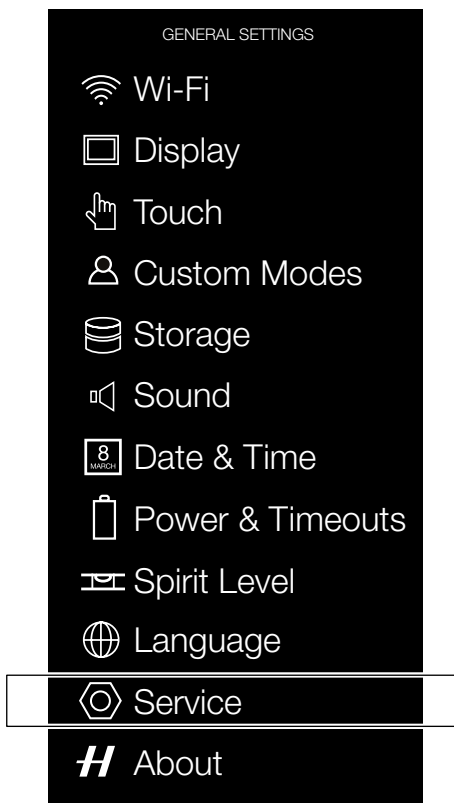

Service Menu

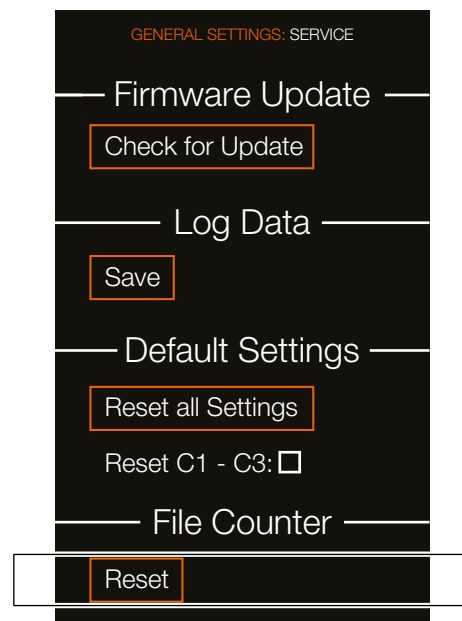

How to Reset the File Counter:

- 1 Press MENU.
- 2 Navigate to General Settings.
- 3 Navigate to Service.
- 4 Under File Counter, select Reset. A dialogue will appear asking for confirmation.
- 5 Press OK.
- 6 After confirmation, the File Counter will be reset and the next captured image (or video recording) will be numbered B00000001.
- 7 If the current folder on the memory card is not empty when a Reset is performed, a new folder will be created on the memory card. This is done to avoid the possibility of two captured images (or video recordings) being labelled with the same name and file number.

File Counter Reset Dialogue

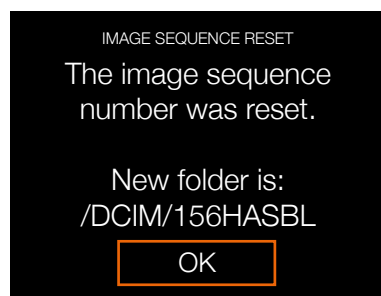

Note!

A new folder is created if there are images present on any inserted active SD memory Card.

4.29 GENERAL SETTINGS ABOUT

MAIN MENU > GENERAL SETTINGS > ABOUT

- 1 Press the General Settings icon on the Touch Display.
- 2 The General Settings Menu appears.
- 3 Press the General Settings About icon.

Swipe right or press Menu / EXIT button to get back to Main Menu.

About Menu Settings

Firmware

The About box will tell you which firmware version is present so you can see if you have the latest firmware (can be downloaded from the Hasselblad website).

Lens Firmware

The Lens Firmware (v0.5.16) is displayed in the About menu.

Serial Number

The serial number is also displayed in case Hasselblad Support needs to know it for problem solving.

Licenses

Displays the available Licenses.

Certification

Displays the available Certification.

Usage

Displays the total number of the currently mounted lens exposures. 8960 in this example to the right.

General Settings Menu

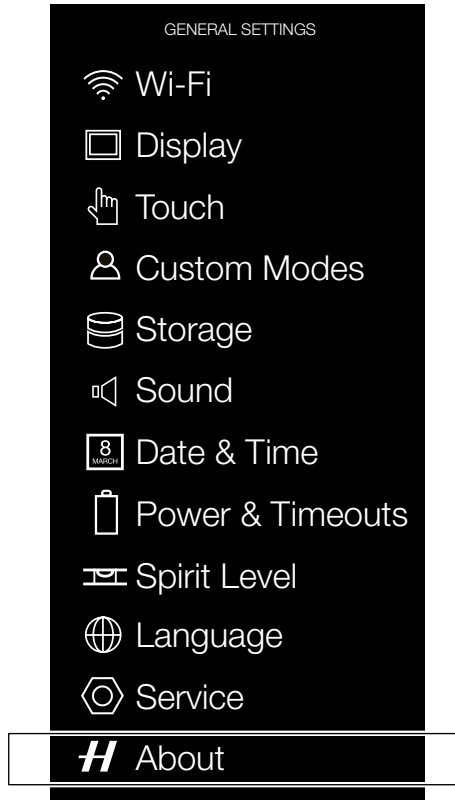

About Menu

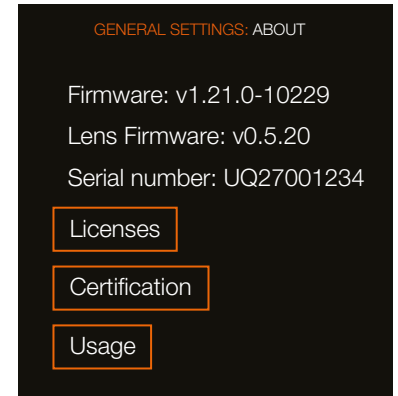

Lens Exposure Usage information

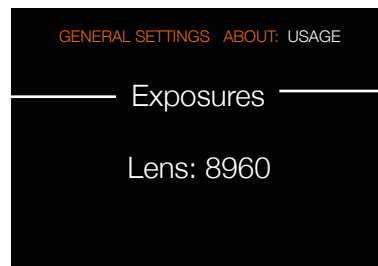

4.30 GENERAL SETTINGS ABOUT CERTIFICATION

MAIN MENU > GENERAL SETTINGS >
ABOUT > CERTIFICATION

- 1 Press the General Settings icon on the Touch Display.
- 2 The General Settings Menu appears.
- 3 Press the General Settings About icon.
- 4 Press the Certification icon.

Swipe right or press Menu / EXIT button to get back to Main Menu.

General Settings Menu

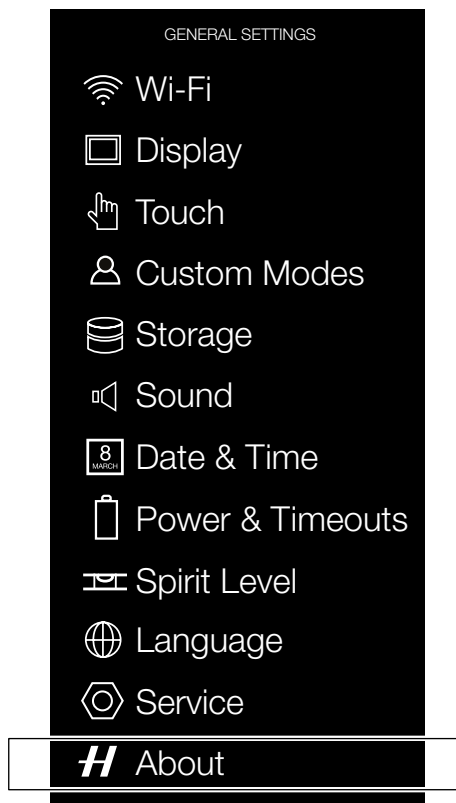

About Menu

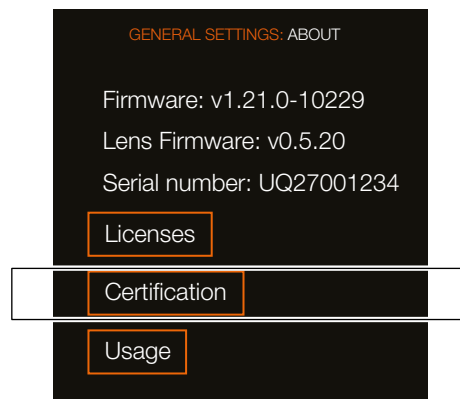

Certification E-label

Depending on region certification, information in addition to what is engraved underneath the camera, can be found on an E-label.

From the Main Menu this label is displayed by pressing General Settings > About > Certification.

Certification dialogue

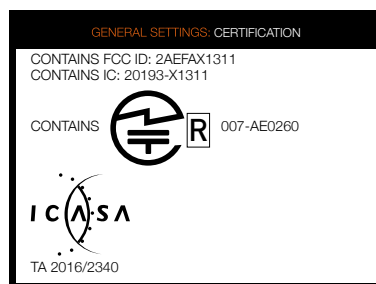



5.1 XCD LENS RANGE



XCD 30 LENS

The XCD 30 is a fixed 30 mm Lens that has Autofocus and Manual Focus capabilities.



XCD 45 LENS

The XCD 45 is a fixed 45 mm Lens that has Autofocus and Manual Focus capabilities.



XCD 90 LENS

The XCD 90 is a fixed 90 mm Lens that has Autofocus and Manual Focus capabilities.



XCD 120 MACRO LENS

The XCD 120 is a fixed 120 mm Lens that has Autofocus and Manual Focus capabilities. Focuses down to an image scale of 1:2.

XH LENS ADAPTER

(3025000)

The XH Lens Adapter can be used to mount an HC or HCD Lens onto the X1D Camera.

The XH Lens Adapter widens your X1D lens choices to include all 12 H-system HC/HCD lenses, and accessories including a macro converter and 3 extension tubes.

The HC/HCD lens range includes a 24 mm wide angle lens, a 300 mm telephoto lens and a 100 mm f 2.2 lens, delivering small depth-of-field range and a beautiful, smooth Bokeh.

Note!

Currently the X1D Camera supports the XH Lens Adapter with Auto Focus for all HC/HCD Lenses, except the HC 120 Macro. Requires the X1D to have firmware version 1.21.0 or later.

- AF with the lenses above, requires lens firmware 19.0.2 or later.
- Only HC/HCD lenses with firmware 18.0.0 or later can be updated for AF functionality. Lenses with older firmware have older hardware and cannot be updated with this firmware. They can only be used in Manual Focus Mode.
- AF is not possible when using Converter or Extension Tubes.



XPAN LENS ADAPTER

(3025001)

The XPan Lens Adapter is used to attach lenses that was made for the XPan Camera. Available XPan lenses was 5,6/30mm, 4/45mm and 4/90mm.

Note!

XPan Lenses had no built-in shutter. Consequently, they can only be used when the electronic shutter of the camera is activated.



5.2 OPTIONAL HC LENS ACCESSORIES

H 13, 26 AND 52 EXTENSION TUBES

(3053513, 3053526 and 3053542)

The Extension tubes attach between the XH Lens Adapter and the HC Lens to reduce the close focusing distance for close up photography. They are available in three sizes: 13 mm, 26 mm and 52 mm. As the X1D has a TTL light metering system, exposure compensation is automatic.



MACRO CONVERTER H

(3023720)

The Macro Converter H is mounted between the XH Lens Adapter and the HC Lens and is designed to improve the close range performance of wide angle H system lenses. It is primarily intended for use with the HC 50-II lens for optimum performance. The range produced is similar to the use of a 6.6 mm extension tube but the performance is noticeably improved.



CONVERTER H 1.7X

(3023717)

The Converter H 1.7x is mounted between the XH Lens Adapter and the HC Lens. Then Converter H 1.7x increases the focal length of a lens by a factor of 1.7x. It features the same outstanding optical and mechanical quality as the elements in the Hasselblad H-lens series.



5.3 OPTIONAL ACCESSORIES

PRO SHADE V/H 60 – 95

(3040740)

An adjustable bellows lens shade that provides highly efficient protection against stray light. The compact, flat folding design saves space in the equipment case. It also features a filter holder for glass, gelatin, or plastic filters.



PRO SHADE ADAPTERS

(3043415, 3043417, 3043419)

67 mm, 77 mm and 95 mm adapters with bayonet mount for HC lenses. Features lock to provide positive and secure attachment.



XCD LENS FILTER DIMENSIONS

XCD 30	77 mm.
XCD 45	67 mm.
XCD 90	67 mm.
XCD 120 Macro	77 mm.

UV SKY FILTERS

(3053470, 3053474 and 3053478)

Absorbs UV radiation and reduces blue haze without affecting colours. Also protects the front lens surface. Particularly recommended when the camera is used in harsh conditions. Available in three sizes to suit various lenses: UV Sky 67mm (3053470), UV Sky 77mm (3053474) and UV Sky 95mm (3053478).



POLA FILTERS

(3053482, 3053486 and 3053490)

Reduces non-specular reflections and glare. Increases colour saturation in general. Can intensify a blue sky. Available in three sizes.



X1D CAMERA SHOULDER STRAP

(3054754)

Extra wide camera strap with anti slip backing Included as standard accessory.





Problem	Possible cause	Suggested correction
Camera is deactivated	<p>The camera can be affected by a discharge of electricity. This can happen when the area around the control buttons on the grip accidentally touches a conductive cord or material connected to earth.</p> <p>This can deactivate the camera and does not cause any damage.</p>	Remove and re-insert the battery, then press the ON - OFF button on the camera to turn on the camera.
Wrong language	If the Camera has been set to a language you don't understand, you can navigate to your preferred language by following the actions and appearance in the illustrations in the suggested section.	See page 145 how to change language on the camera from an unknown language.
Dark or coloured spots or lines in your images	Dirt or particles on the surface of the sensor infrared (IR) filter.	See "6.4 Clean the Sensor Filter" on page 147.
Temperature warning icon appears	<p>Rapidly taken captures make heavy demands on the processor in the Camera which in turn produces heat. This can in combination with high ambient temperature result in noise in the image files.</p> <p>At around 60 °C a warning dialogue appears notifying that the sensor is temporarily shutting down to allow the Camera to cool.</p>	Let the Camera cool down for at least 20 minutes.

6.1 ERROR MESSAGES

Caution!

Be careful when you attach/remove the components to/from the camera. This will help prevent damage to the data bus connections.

If any error message is displayed

- 1 Remove the components from the camera.
- 2 Attach the components to the camera again.

If the error message is still displayed

- 1 Remove the battery.
- 2 Wait 10 seconds.
- 3 Attach the battery again.
The Camera processor is now reset.



If the error message is still displayed

- 1 Write down the error message.
- 2 Contact your closest authorized Hasselblad dealer.



6.2 CHANGE FROM UNKNOWN LANGUAGE

MAIN MENU > GENERAL SETTINGS > LANGUAGE

- 1 Press the General Settings icon on the Touch Display.
- 2 The General Settings Menu appears.
- 3 Navigate to the menu item with a Globe icon (number 9 on the list from the top, Language).
- 4 Scroll down to select your Language.

Swipe right or press Menu / EXIT button to get back to Main Menu.

General Settings Menu

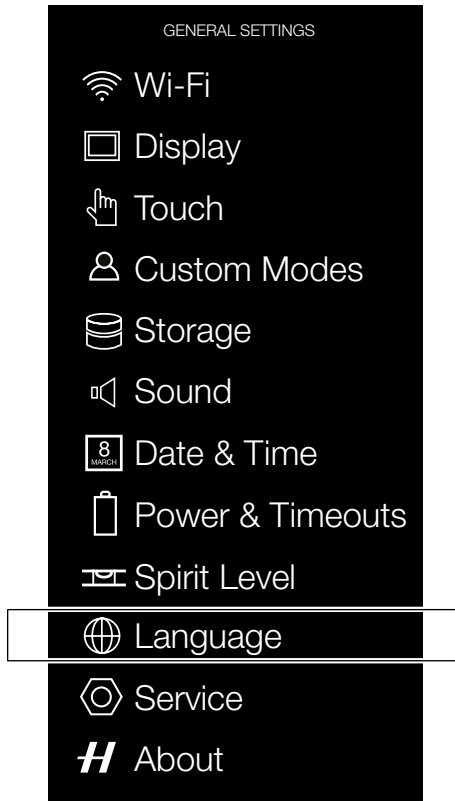

Language Menu

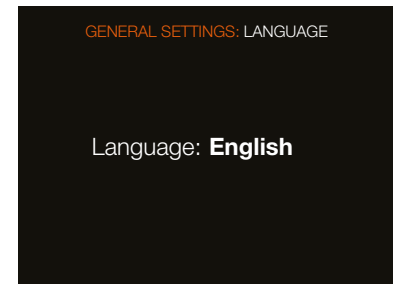

6.3 CLEAN THE LENS GLASS

REMOVE DUST

Caution!

Do not touch the glass surface with your fingers. This can cause damage to the equipment.

If there is dust on the lens glass, do as follows:

- 1 Remove the dust with an air blower.
- 2 If that does not solve the problem, try to remove dust with a very soft lens brush.

REMOVE SMEAR

Caution!

Do not touch the glass surface with your fingers. This can cause damage to the equipment.

If there is smear on the lens glass, do as follows:

- 1 If you are not sure how to remove the smear, contact your local Hasselblad Authorized Service Centre.
- 2 Clean the lens glass with a high quality lens cleaning solution on a tissue.



6.4 CLEAN THE SENSOR FILTER

Caution!

Be careful when you attach/remove the components to/from the camera. This will help prevent damage to the data bus connections.

Caution!

When you remove the lens, keep foreign objects away from the camera opening. The camera opening is very sensitive. This will help prevent damage to the equipment.

Remove the Lens and clean the Sensor

- 1 Remove USB 3 cable if connected.
- 2 Press and hold the Lens Release button.
- 3 Rotate the Lens counter clockwise.
- 4 Remove the lens.
- 5 Carefully clean the outside surface of IR filter by using clean compressed air.

Caution!

If you use canned compressed air to clean the glass of IR filter, read the instructions very carefully before use. This will help prevent damage to the filter.

If compressed air did not remove all the problems on the filter, use an E-wipe. Do as follows:

- 6 Tear at the notch to break seal.
- 7 Remove an E-wipe from the package and fold the tissue to match the width of the IR filter.
- 8 Apply firm pressure using two or three fingers at the edge of the wipe to ensure an even, firm contact with filter surface.
- 9 Wipe the surface in one unbroken motion.

Note!

Do not use same side of the E-wipe twice as you will be likely to reapply particles removed in the first pass.

10 Attach the Lens again to the camera immediately after cleaning.

11 Capture a number of images.

12 Inspect the images.

If you still see spots on your images, you may have dust either on the inside of the IR filter or on the CMOS itself, please contact your Hasselblad dealer.



Caution!

Do not try to remove the glass IR filter from the front of the sensor (due to dust or similar). This will cause damage to the equipment.

6.5 INFORMATION ABOUT THE HASSELBLAD X1D USER GUIDE

The information in this User Guide is intended for informational use only. The information and the 3D Product Images and Photos, are subject to change without notice, and should not be construed as a commitment by Victor Hasselblad AB.

3D PRODUCT IMAGES

The X1D Product Images in this User Guide were not taken with a Hasselblad X1D. They are produced in 3D as visualization. They are used for illustrative purposes only and are not intended to represent the image quality produced by a Hasselblad X1D.

TRADEMARKS

Hasselblad, Phocus and Phocus Mobile are trademarks of Victor Hasselblad AB.

Adobe and Adobe Photoshop are trademarks of Adobe Systems, Inc. Macintosh, Mac OS, iPhone®, iPad® and iPod Touch® are trademarks of Apple.

InfoLithium is a registered trademark of Sony Corporation. Canon, Nikon, Leica, Sony, Fuji and Olympus are trademarks of their respective corporations. Qp Card is a trademark of Qp Card AB. E-Wipe is a trademark of Photosol Inc.

COPYRIGHT

All text in this User Guide copyright © Victor Hasselblad AB. All images in this User Guide, not credited to a specific photographer, copyright © Victor Hasselblad AB. The text, or parts of the texts, in this manual cannot be reprinted or reused without the written express permission of Victor Hasselblad AB.

The images in this User Guide cannot be reprinted or reused without the written express permission of the photographers who owns the copyright.

Victor Hasselblad AB assumes no responsibility or liability for any errors or inaccuracies that may appear in this User Guide. Victor Hasselblad AB assumes no responsibility or liability for loss or damage incurred during, or as a result of using Hasselblad software or products.

Copyright © 2018 Victor Hasselblad AB. All rights reserved.

