

# CamFi User Guide

CamFi Remote Camera Controller



# Contents

<b>Chapter 1: CamFi at glance</b> .....	1
<b>Packaging List</b> .....	1
<b>CamFi Overview</b> .....	1
<b>Chapter 2: Getting started</b> .....	2
<b>Charging battery</b> .....	2
<b>Quick installation</b> .....	2
Connect CamFi with your camera .....	2
Get the CamFi app .....	2
Connect to the Wi-Fi hotspot of CamFi .....	2
Start CamFi App .....	3
Firmware Upgrade .....	3
<b>Chapter 3: Using the iOS App</b> .....	4
<b>Remote capture</b> .....	5
Live view .....	5
Change the capture settings .....	5
Time-lapse .....	6
Quick mode .....	6
Advanced Mode .....	6
Grid .....	7
Manual Focus .....	7
Auto Focus .....	8
Zoom in / Zoom out live view .....	9
Advanced bracketing .....	10
Focus stacking .....	11
Video .....	12
<b>Auto view</b> .....	13
<b>Browse photo</b> .....	14
View the photos .....	14
Share .....	14
Download .....	15
Delete .....	15

<b>Settings</b> .....	16
Wireless Settings .....	16
Network Settings .....	16
<b>Chapter 4: Precautions and FAQ</b> .....	17
<b>PRECAUTIONS</b> .....	17
Battery charging and maintenance .....	17
Hardware connection .....	17
Transmit speed .....	17
<b>FAQ</b> .....	18

# Chapter 1: CamFi at glance

## Packaging List

1. CamFi remote camera controller
2. Mini USB cable for connecting to the camera
3. Micro USB cable for charging the battery
4. Double screw to hot shoe adapter
5. Lanyard
6. Quick start guide

## CamFi Overview

- ① USB connector for connecting to the camera
- ② Network port for connection to the PC
- ③ Status Indicators

### 📶 System status

Flashing indicates the system is starting up

Always on after the system starts up successfully

### 🔋 Battery status

Turned on when the battery is running low

### ⚡ Battery charging status

Turned red when the battery is being charged.

Turned green when the battery is charged fully.

- ④ Battery charging port
- ⑤ Reset button
- ⑥ Lanyard hole
- ⑦ Power switch
- ⑧ Tapping hole for hot shoe adapter

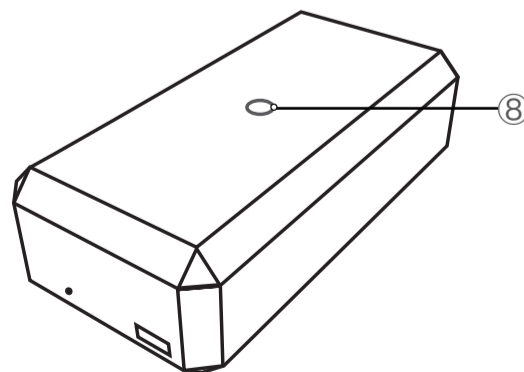
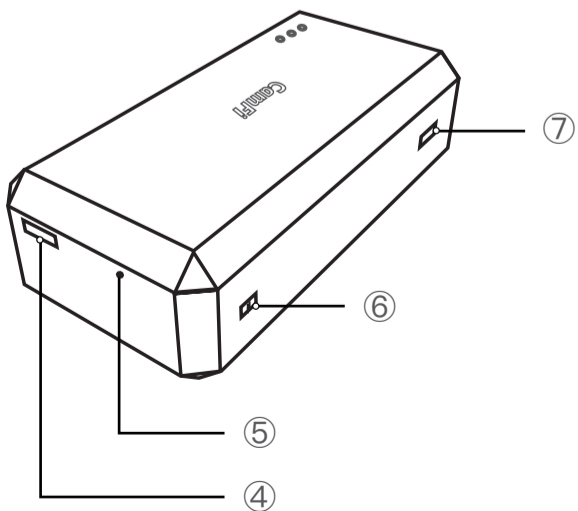
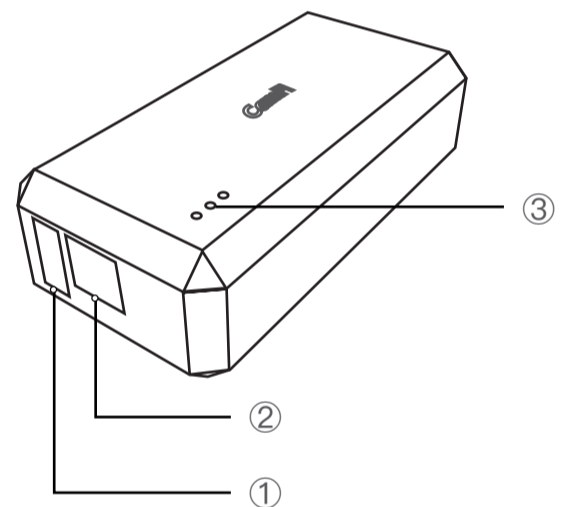

## Chapter 2: Getting started

### Charging battery

Use the micro USB cable to connect to a mobile phone charger or the USB port of a computer to charge the battery of the CamFi device.

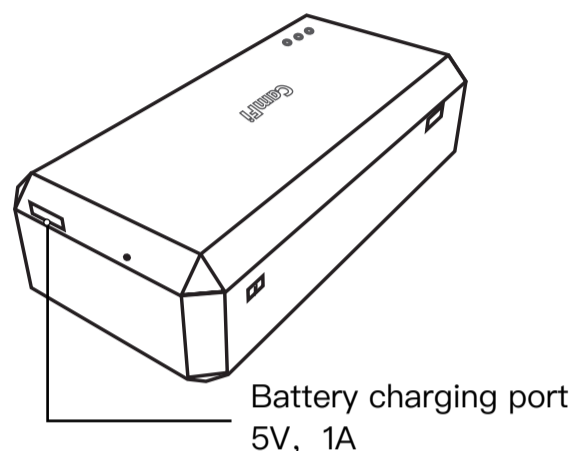

### Quick installation

#### Connect CamFi with your camera

Connect the CamFi device with your camera using the mini USB cable, then turn on CamFi and your camera.

#### Get the CamFi app

You will need to install the CamFi app on your smartphone or your PC. The CamFi app is available for iPhone®, Android™, Windows®, Mac OSX®. For a full list of supported devices, visit: <http://www.cam-fi.com/download.html>

1. On your smartphone or your computer browser, visit: <http://www.cam-fi.com/download.html>
2. Follow the instructions to install the CamFi app on your smartphone or your computer.

#### Connect to the Wi-Fi hotspot of CamFi

After you turn on CamFi and the system status indicator light turns constant green, you can find and connect to the Wi-Fi hotspot of CamFi with the name prefixed with "CamFi" on your smartphone or your computer.

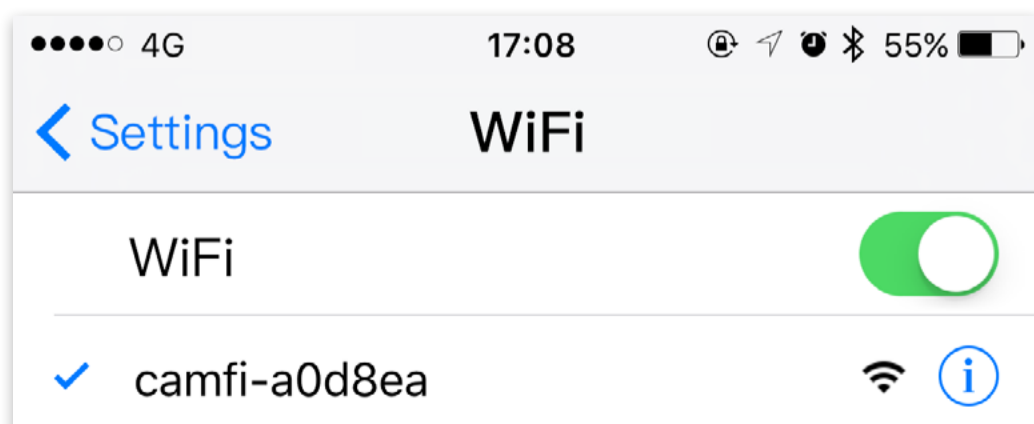

## Start CamFi App

Launch the CamFi app on your smartphone or your computer.

## Firmware Upgrade

The CamFi app will automatically check if there is a new version firmware available for the CamFi. When there is a new version available, the app will start the upgrade wizard to upgrade the firmware of the CamFi. You can follow the instructions provided by the wizard to upgrade the firmware.

**Note: It needs to connect the CamFi's Wi-Fi again after the upgrade.**

# Chapter 3: Using the iOS App

The CamFi app supports iPad, iPhone, Android, Windows and Mac. We'll only introduce the iOS app to illustrate the use of CamFi. The apps on the other platforms are similar, and any parts where significant differences exist will be called out.

The user can slide the toolbar to show more buttons.

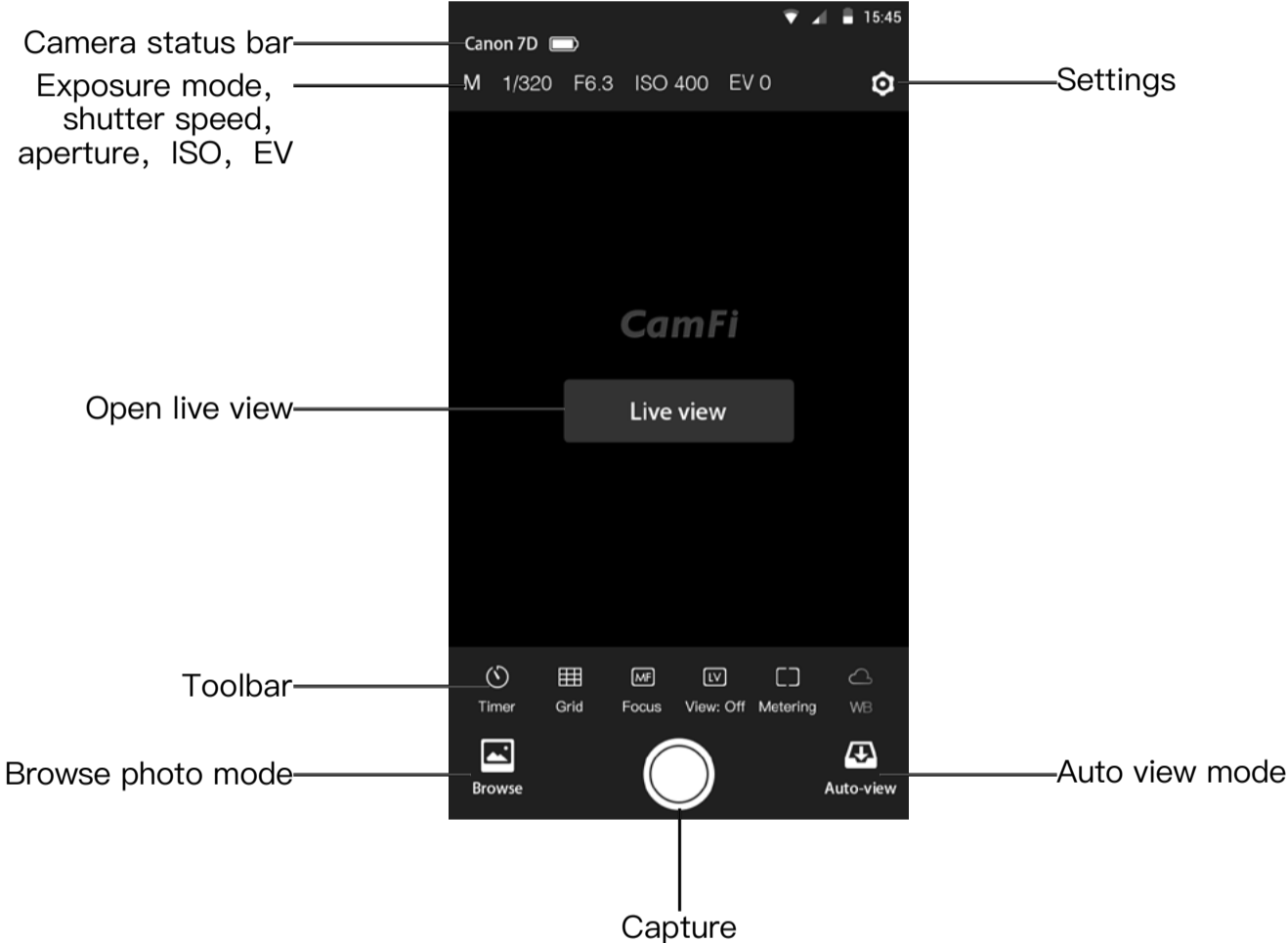

# Remote capture

Tap the shutter button at the bottom to remote control the camera to capture.

## Live view

Tap the “Live view” at the center of the screen or the “View On” button at the bottom to start the live view.

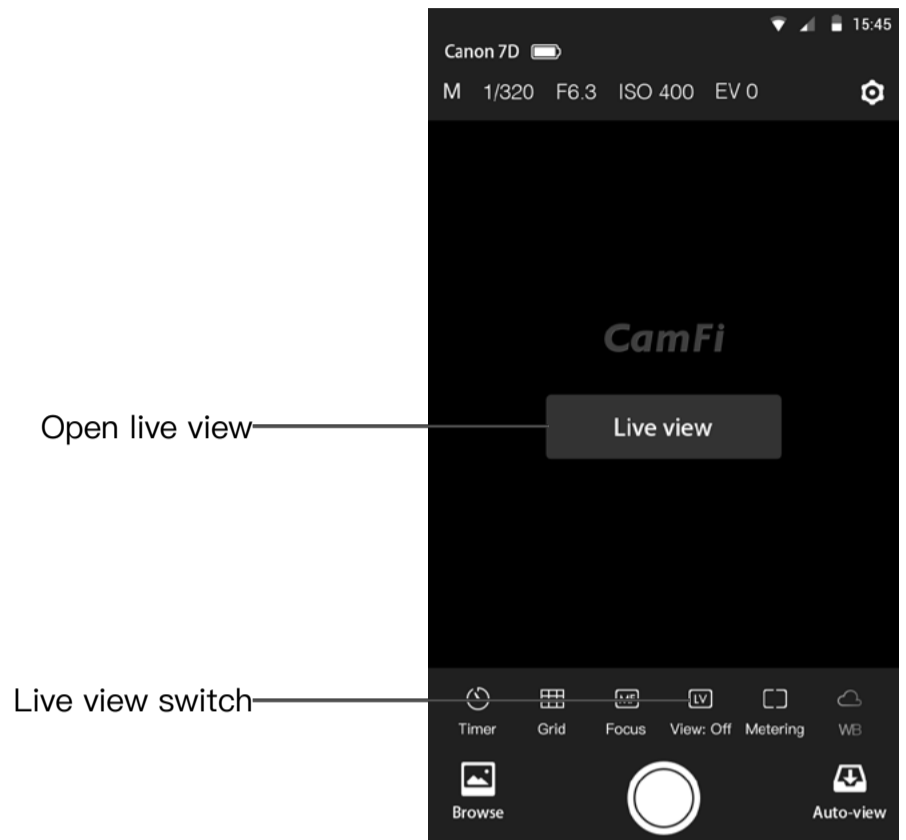

## Change the capture settings

To change the capture settings, please tap the top area of the screen where shows the exposure mode, shutter, aperture and ISO.

It will pop up a setting window. User can drag the sliders to change the settings.

Note: the exposure mode for Canon camera cannot be set.

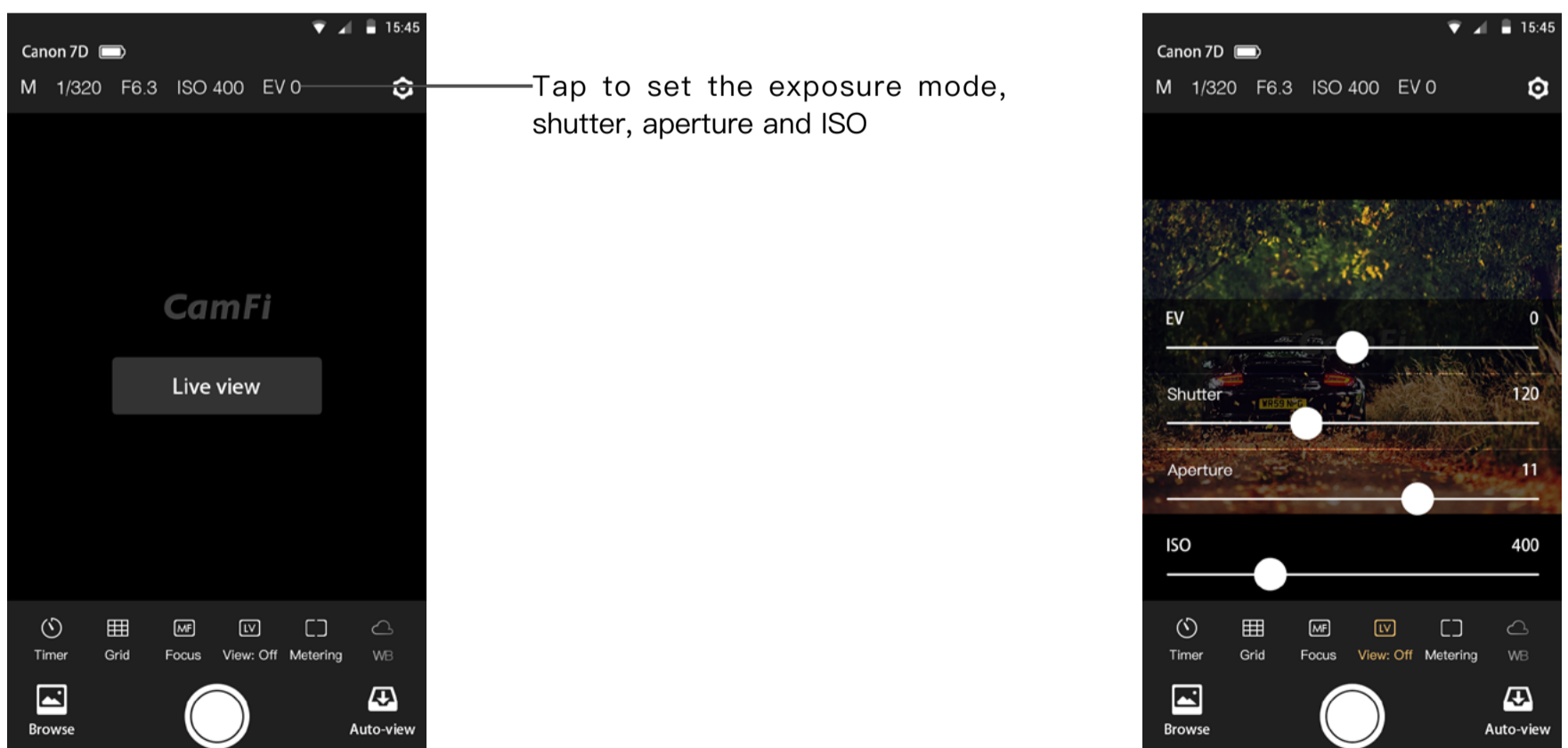



## Time-lapse

There are two modes for time-lapse: the quick mode and the advanced mode.

### Quick mode

It has two options, 3s and 10s. You can use it for quick self-portrait.

### Advanced Mode

After switching to the advanced mode, you may change the following properties:

- Start-up time
- Shooting interval
- Shooting numbers
- Bulb mode
- Bulb time

After setting, tap the Start button to begin capture.

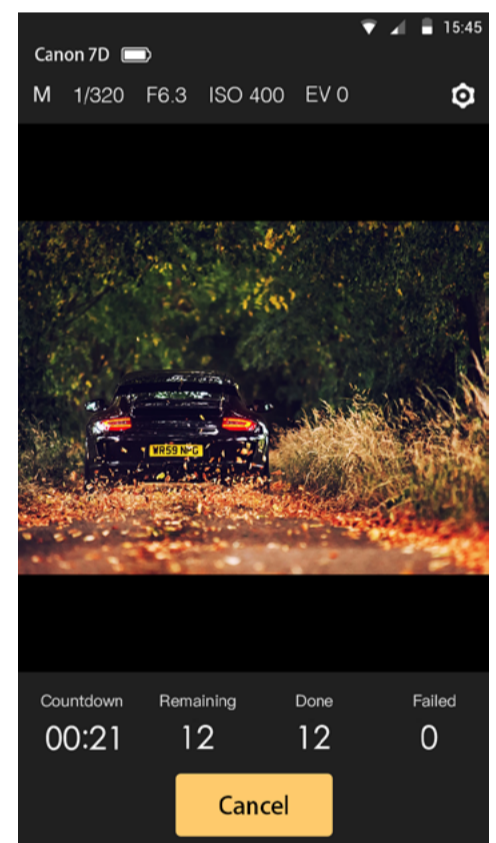
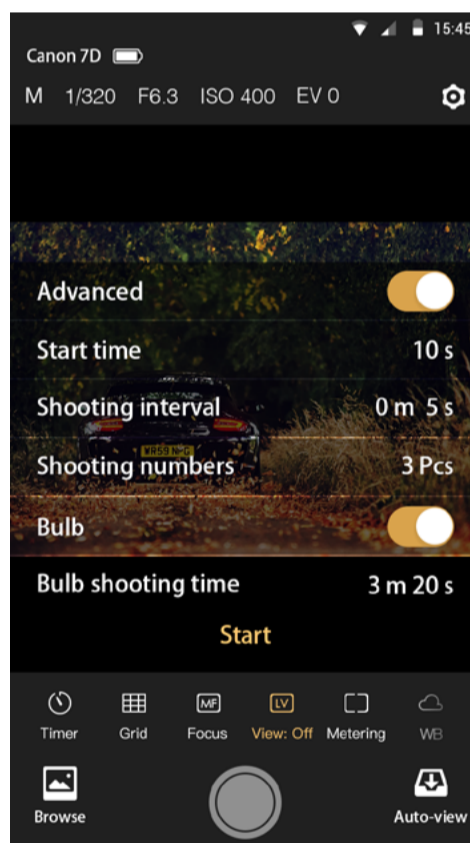
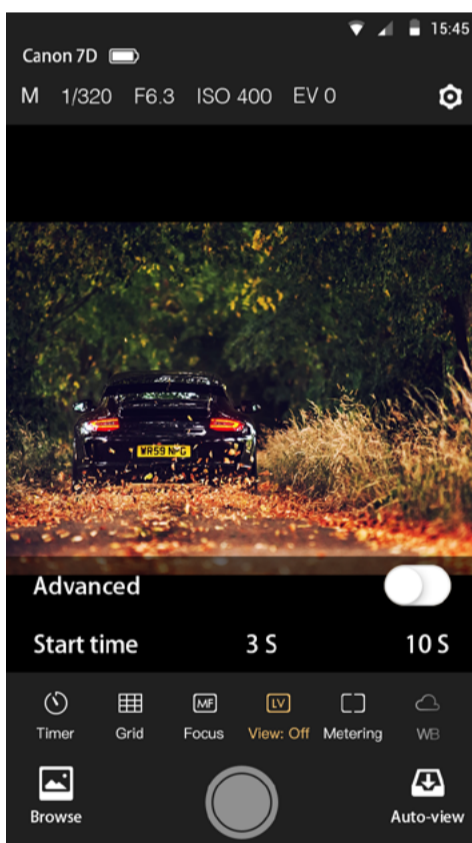

# Grid

Show and hide the grid.

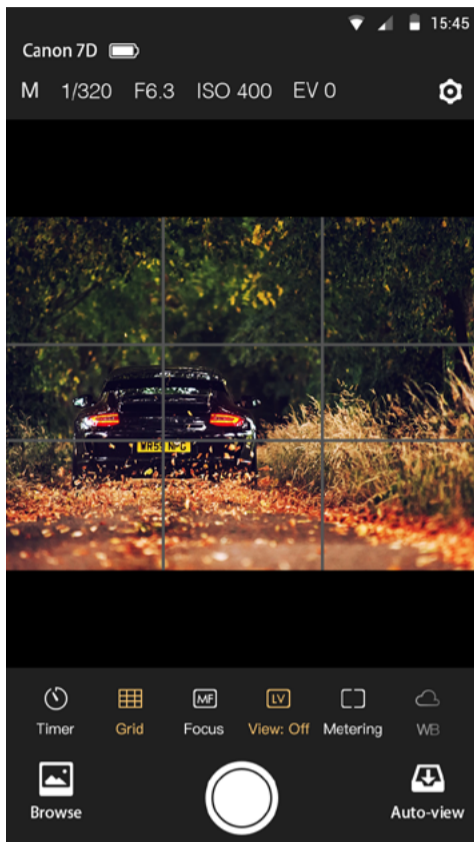

# Manual Focus

Please tap the Manual Focus button to change the focus manually. Manual Focus can only be used when the lens is set to AF mode and the live view is on.

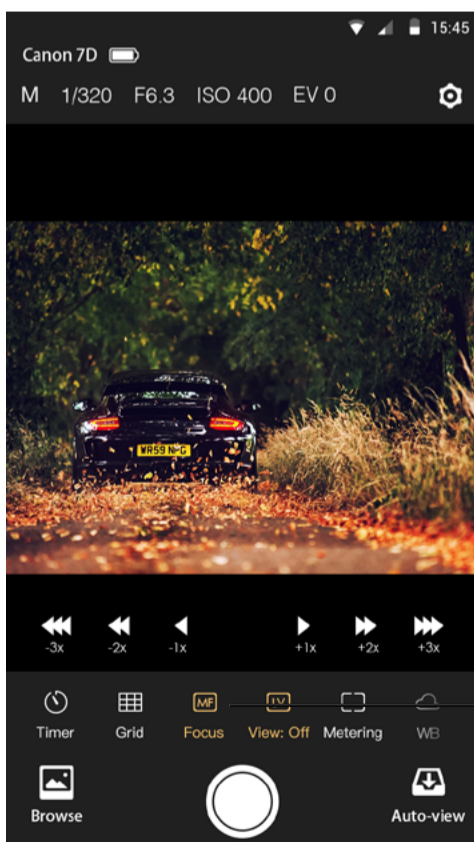

Manual focus

## Auto Focus

Tap the viewfinder and the camera will try to focus automatically. Auto Focus can only be used when the lens is set to AF mode and the live view is on.

1. For Canon, you need to change the AF options to the live mode by using the camera's menu button. Quick or Face Detect Live modes are not supported by the app.
2. For Nikon, it will not work if the AF area mode is Face priority or Subject tracking. Please change the mode to Wide area or Normal area.

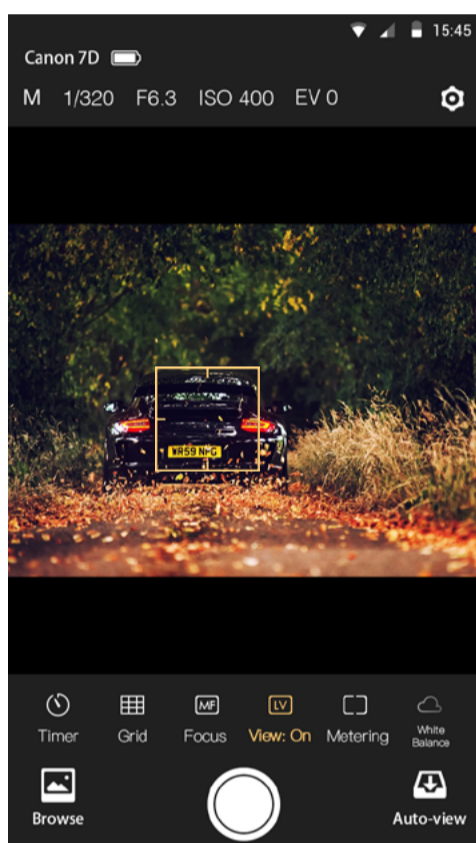

## Zoom in / Zoom out live view

When live view is on, double tapping or spreading gesture can zoom in live view.

The “White Capture” button changes to “Record” and pressing the “Record” button will start and then stop the recording of a video.

The camera should not explicitly be put into a separate movie mode if such a mode exists, whether through a dial or switch.

Note: movies cannot be downloaded to the iOS device.

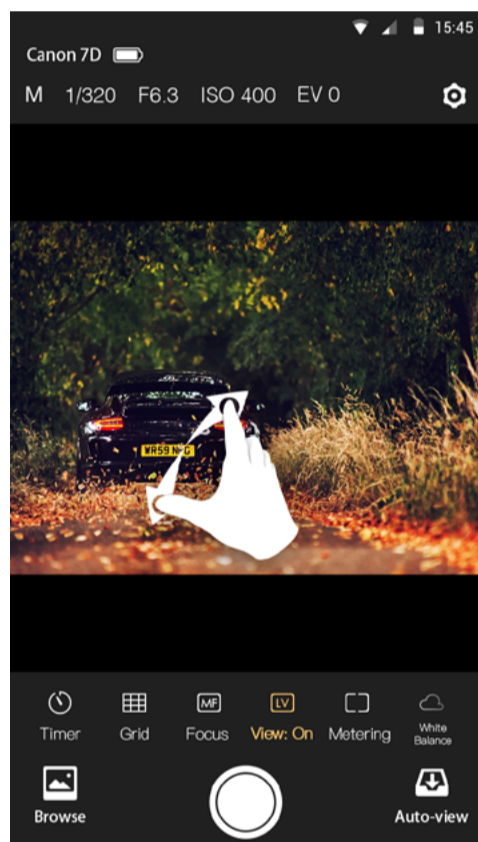

## Advanced bracketing

Advanced bracketing can be used to generate a series of photos with varying exposures.

- Advanced bracketing is only enabled when the camera is in Manual mode.
- The Property field specifies the camera property to be varied. There are three options, Shutter Speed, Aperture, and ISO.

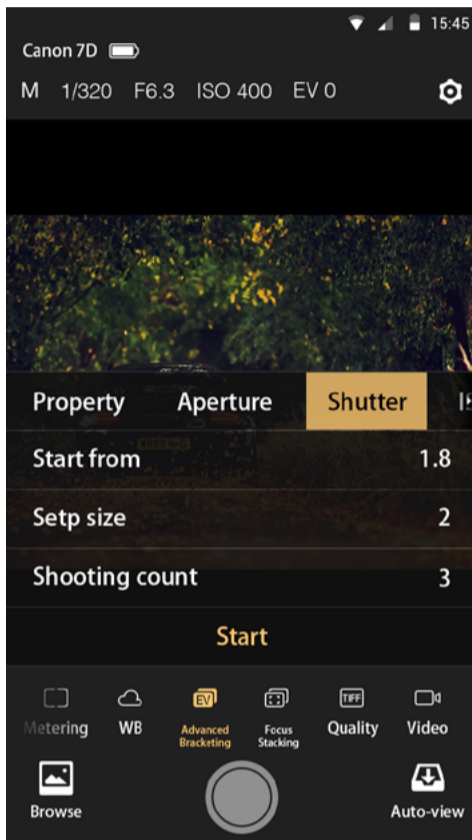

# Focus stacking

Increasing the depth of field by taking a series of photographs with different focus settings.

Focus stacking can only be used when the lens is set to AF mode.

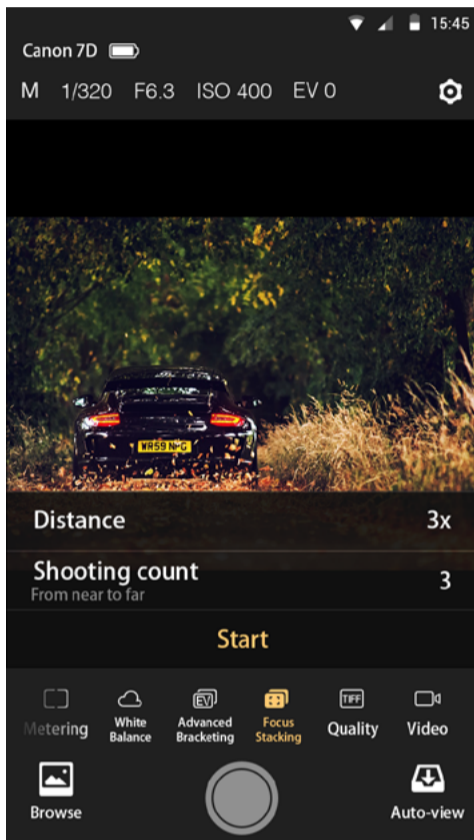

## Video

Tap the video button to change the camera to video record mode.

The white capture button will change to red when it is in the video mode. Tap the button will start and then stop the recording of a video.

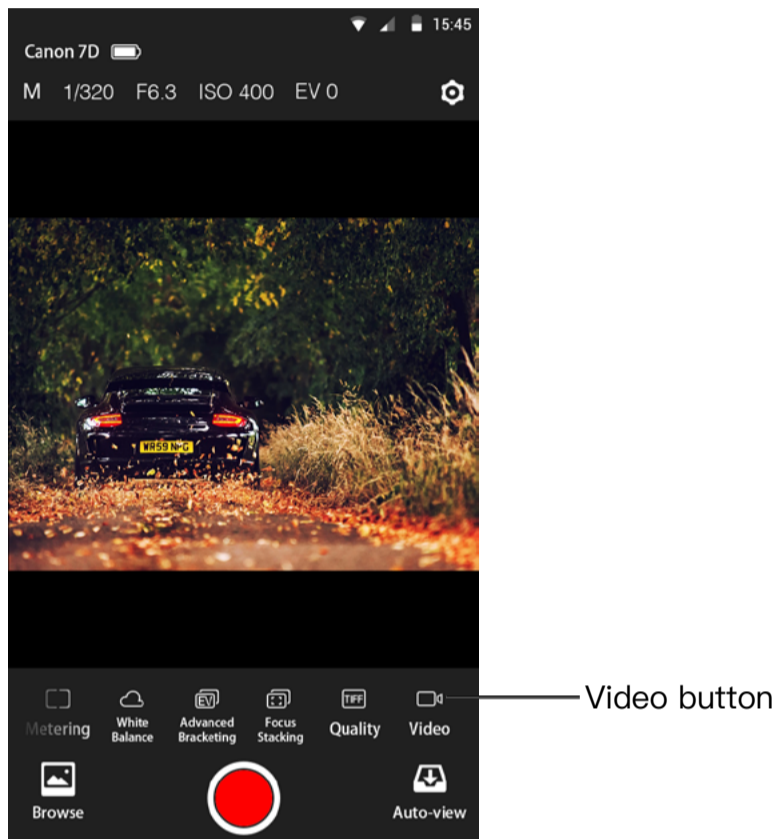

# Auto view

Tap the Auto View button to start the Auto View mode.

Once the app is in the Auto View mode, the photos captured by the camera manually can be streamed to mobile phones, tablets, and PCs. This feature can be used to show the photos immediately to the client or model on a large screen as the photos are taken.

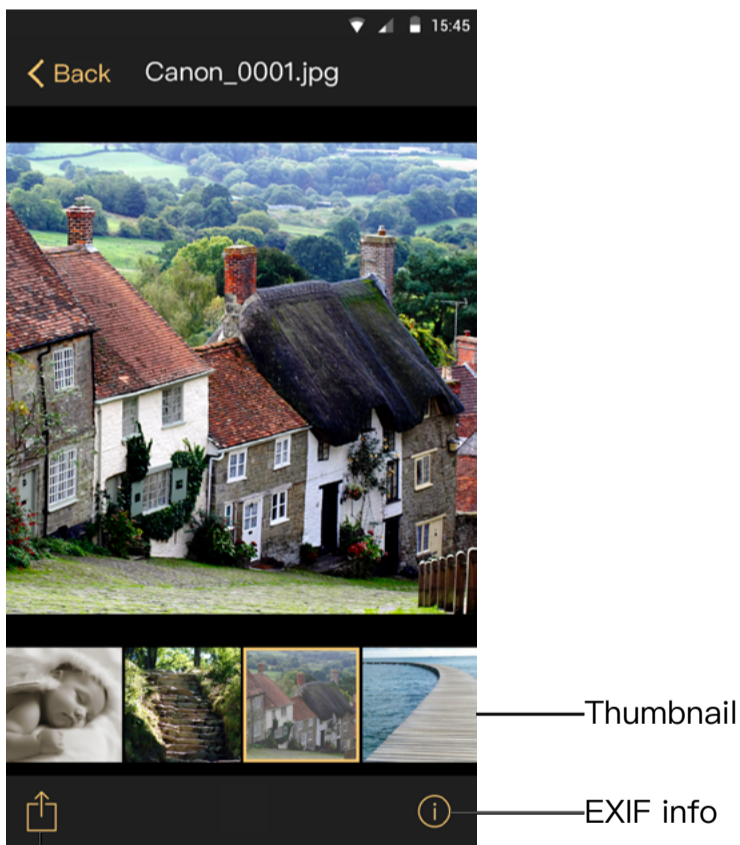
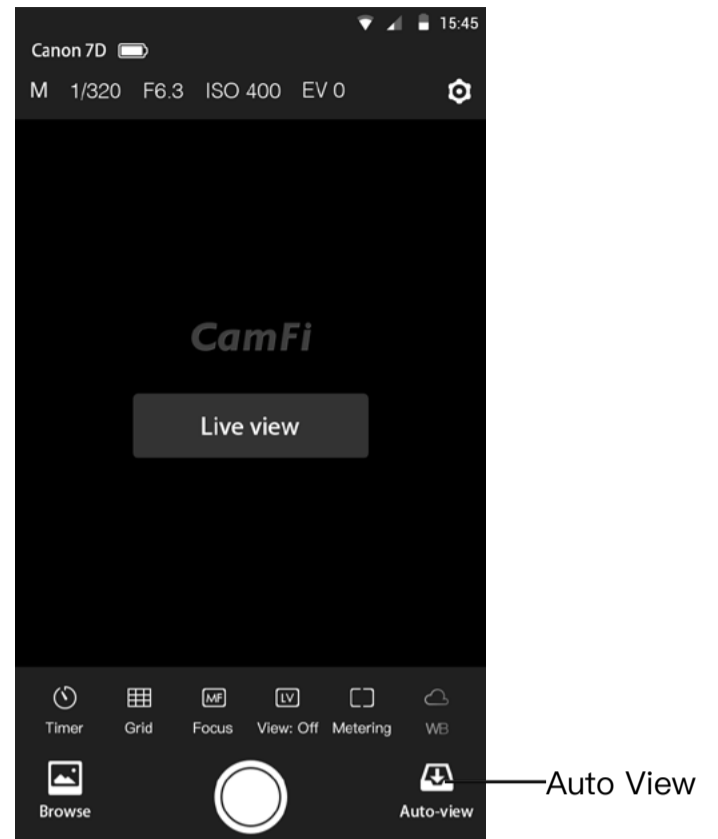

Share and save

The raw file format is also supported, and it uses a smart-view technology to view the raw files, which is much faster than other technology types.

The transmit speed for Auto View is about 2–3MB/S and the speed is dependent on the transmit distance and signal interference.



# Browse photo

## View the photos

Tap the thumbnail in the lower left to start the browse mode. After entering the browse mode, you may tap the thumbnail to view a large image.

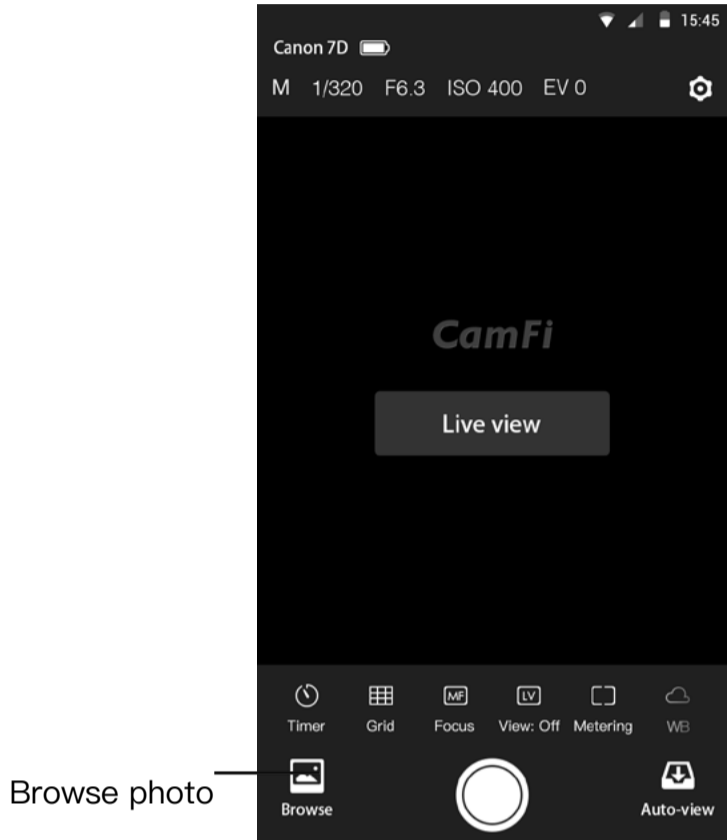

## Share

While viewing thumbnails, tap Select, select items, tap the action button on the bottom left, and select Share to share the photo to your social networks.

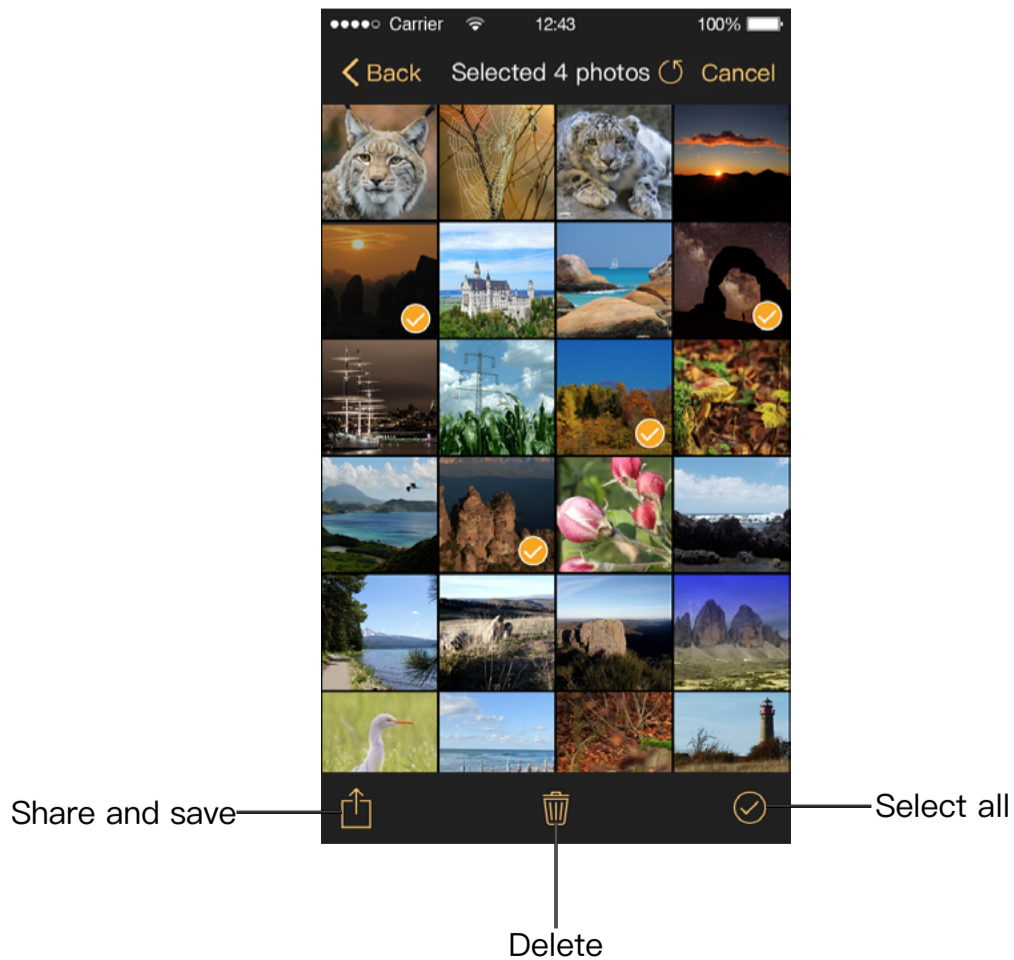

## Download

- While viewing thumbnails, tap Select, select items, tap the action button on the bottom left, and select Original or Standard to download the selected photos.
- Original is for downloading the raw files or JPEG photos. Choosing this option will download the photo to the album just like the camera.
- When you select Standard, the photo will be resized to a smaller size and saved to the album as JPEG.

## Delete

While viewing thumbnails, tap Select, select items, tap the delete button on the bottom center to delete the selected photos in the camera.

# Settings

To change CamFi's settings, please tap the top right Settings icon to open the Settings view.

## Wireless Settings

Go to Settings → Wireless to:

- Change the SSID of the CamFi
- Set the password of the CamFi
- Change the channel of the CamFi

## Network Settings

- Go to Settings→Network to:
- Change the IP address of the CamFi
- Change the subnet mask
- Change the gateway
- Change the DNS

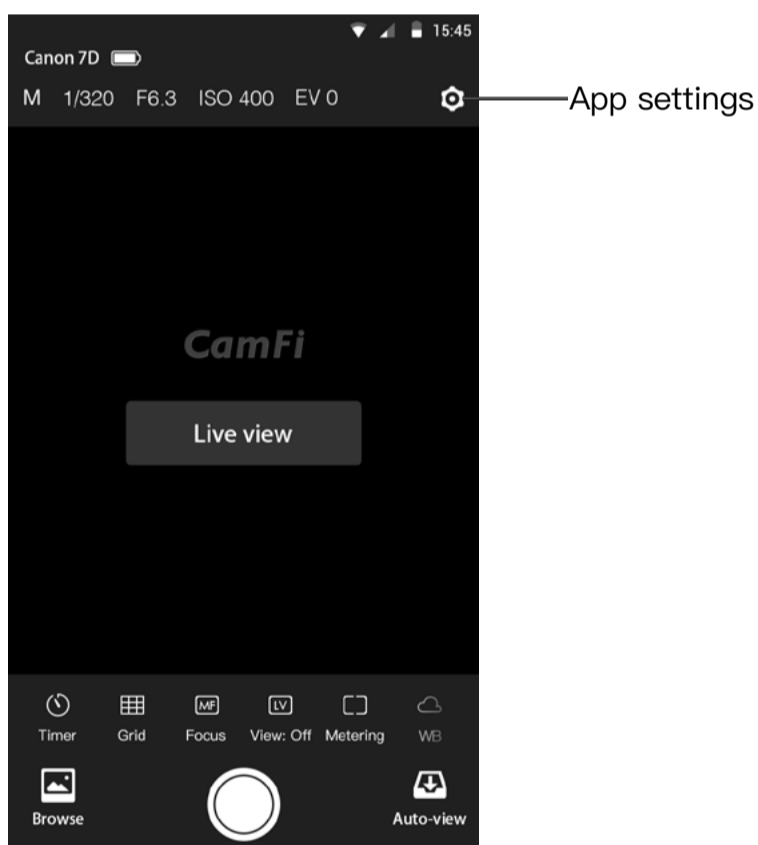

# Chapter 4: Precautions and FAQ

## PRECAUTIONS

### Battery charging and maintenance

1. a. Please recharge the CamFi for the first use or if it is left unused for a long time. The requirement for a charger is 5V/1A, and the usual charger for a mobile phone like an iPhone or iPad can also be used.
  2. b. The working temperature for the CamFi is  $-20\sim 50$  Celsius degree and the relatively humidity is  $0\%\sim 95\%$ . Low temperature may cause degradation to the battery.
  3. c. Charging your mobile phone through the CamFi is not recommended, as this will cause degradation to the battery.
  4. d. Please keep CamFi from high temperature, moisture and water.
1. 1. It is strongly recommend that you use the provided USB cable of the camera to connect the CamFi. Low quality USB cables will cause unstable or poor connection and unexpected problems.
  2. 2. You can use the lanyard in the accessories to hang the CamFi to the tripod or use the hot shoe screw to install the CamFi.

### Transmit speed

The transmission of the CamFi is the standard IEEE802.11bgn and the fastest speed is 150Mbps. The transmit distance is the same as a usual WiFi equipment. The actual transmit speed of the CamFi is dependent on the camera, wireless network environment and distance. You can take the following measures to improve the transmit speed.

1. Turn off other Wi-Fi devices.
2. Remove the obstacles between CamFi and controlled terminals, especially those like metals and concrete.
3. Try to place the CamFi on a higher position.
4. Try to use the CamFi with a full battery. Low battery may cause the instability the transmission.
5. Try to use the original USB cables provided instead of other compatible USB cables.

### Hardware connection

## FAQ

### **Why does the app always pop up a window asking to input IP address?**

It is always caused by that the client device does not connect to the CamFi's Wi-Fi hot spot. To solve this issue, please tap the home button, and tap the Settings->WLAN, select the network named camfi-XXXXX, and then restart the app.

### **The USB cable of CamFi does not fit for my camera, what shall I do?**

The cable of CamFi is designed for standard mini USB 2.0 which is used in most of DSLR cameras. Some new cameras use USB 3.0 port such as Canon 7D mark II, 5Ds, Nikon D810. And some Nikon cameras use the USB port with special size, such as Nikon D3200, D5100 and D7100. So for these cameras, please just use their original cables to connect to CamFi.

### **Can I use a CamFi with the flash lamp or flash trigger at the same time?**

Putting the CamFi on the hot shoe is just for fixation, it is not necessary to always be on the hot shoe. If needed, you can hang CamFi on a tripod or on your wrist, and you can also buy a dual shoe bracket on Amazon, then you can put the flash trigger and the CamFi on the bracket at the same time.

### **Why does the focus function not work?**

1. For Canon, it needs change the AF options to Live mode by using the camera's menu button. Quick mode or Face Detect Live mode is not supported by the app.
2. For Nikon, it will do not work if the AF area mode is Face priority or Subject tracking. Please change the mode to Wide area or Normal area. How to set AF area mode on your Nikon 7100 illustrates the steps thoroughly.

### **How to connect CamFi with PC?**

CamFi supports the following two ways to connect with a PC:

1. Wireless connection. You can connect CamFi to your PC through the CamFi wireless network by using a portable USB Wi-Fi.
2. Cable connection. Connect CamFi to your PC via the LAN cable.

## **How to receive pictures by using TV?**

There are two ways:

1. By using a PC or laptop connected to the TV through our PC client to display the photographs in a photo shoot.
2. By using an Amazon Fire TV stick or other android TV stick. After having installed our TV client app, you can use an LCD TV to show your photos as they are taken.

## **Can the photographs be transmitted between the two floors?**

It is related to the structure of the building because the signal may be weakened through the wall. We recommend that you use the Wi-Fi signal amplifier, or use a cable to connect the devices when the signal is weak.

## **Is there a battery in CamFi? How long can it be used?**

CamFi has a built-in 1800mAh rechargeable battery and it can NOT be removed. The duration of the battery is more than 6 hours for the normal work.

## **Does CamFi use my mobile broadband? Can CamFi be used for outdoor purposes? How about the transmission distance?**

CamFi is a wireless remote controller for DSLR cameras. It is a Wi-Fi transmitter, and as such, it will NOT need your mobile broadband. You can connect a CamFi device to a DSLR camera with a USB cable, then use your mobile phone to connect to the CamFi device over the Wi-Fi to remotely control the DSLR camera, which allows you to view, focus and shoot photos. It supports 802.11n Wi-Fi technology, and has a high transmission speed and wide signal coverage. The Wi-Fi signal can be up to 50 meters in a barrier-free environment.