

*Perfecting the moment*

zhiyun-tech.com



# SMOOTH 3





User Guide V1.0

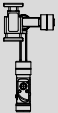

# Contents

■ Packing List	1
■ Disclaimer and Warning	2
■ Battery Safety Guidelines	4
■ Quick Start Guide	8
■ Charging Guidelines	9
■ APP Download and Installation	10
■ Smartphone Installation	11
■ Balance Adjustment	12
■ Start Up	13
■ Introducing Gimbal Control Modes	15
■ Introducing Connection Ports and Various Operations	16
■ APP Operations	17
■ Usage of Main Accessories	21
■ Initialization and Calibration	25
■ Product Specifications	26
■ Warranty Card	27
■ Contact Card	29

The product package comes with the following items. In case that any item is found missing, please contact ZHIYUN or your local selling agent.

	SMOOTH 3 3-Axis Smartphone Stabilizer	1		Micro USB Cable	1
	Battery Compartment	1		26650 Li-Ion Battery	1

Thank you for using ZHIYUN SMOOTH 3. The information contains herein affects your safety and your legal rights and responsibilities. Read this entire document carefully to ensure proper configuration before use. Failure to read and follow the instructions and warnings herein may result in serious injury to you or bystanders, or damage to your device or property.

ZHIYUN reserves the right of final explanation for this document and all relevant documents relating to SMOOTH 3, and the right to make changes at any time without notice. Please visit [www.ZHIYUN-TECH.com](http://www.ZHIYUN-TECH.com) for the latest product information. By using this product, you hereby signify that you have read this document carefully and that you understand and agree to abide by the terms and conditions herein. You agree that you are solely responsible for your own conduct while using this product, and for any consequences thereof. You agree to use this product only for purposes that are proper and in accordance with all terms, precautions, practices, policies and guidelines ZHIYUN has made and may make available.

ZHIYUN<sup>TM</sup> accepts no liability for damage, injury or any legal responsibility incurred directly or indirectly from the use of this product. Users shall observe safe and lawful practices including, but not limited to, those set forth herein.

ZHIYUN<sup>TM</sup> is the trademark of Guilin Zhishen Information Technology Co., Ltd. (hereinafter referred to as "ZHIYUN" or "ZHIYUN TECH") and its affiliates. All product names or marks referred to hereunder are trademarks or registered trademarks of their respective holders.

## Glossary

The following terms are used throughout the product literature to indicate various levels of potential harm when operating this product.

**WARNING:** Procedures, which if not properly followed, may incur property damage, grave accident, or serious injury.

**CAUTION:** Procedures, which if not properly followed, may incur property damage and serious injury.

**NOTICE:** Procedures, which if not properly followed, may incur property damage or minor injury.

### WARNING

Read the ENTIRE User Guide to become familiar with the features of this product before operating. Failure to operate the product correctly can result in damage to the product or personal property and cause serious injury. This is a sophisticated product. It must be operated with caution and common sense and requires some basic mechanical ability. Failure to operate this product in a safe and responsible manner could result in injury or damage to the product or other property. This product is not intended for use by children without direct adult supervision. DO NOT use with incompatible components or in any way otherwise as mentioned or instructed in the product documents provided by ZHIYUN. The safety guidelines herein contain instructions for safety, operation and maintenance. It is essential to read and follow all of the instructions and warnings in the User Guide, prior to assembly, setup or use, in order to operate the product correctly and avoid damage or serious injury.

### Safe Operation Guidelines

- **CAUTION:**
  - 1)SMOOTH 3 is a high-precision control device. Damage may be caused to SMOOTH 3 if it is dropped or subject to external force, and this may result in malfunction.
  - 2)Make sure the rotation of the gimbal axes is not blocked by external force when SMOOTH 3 is turned on.
  - 3)SMOOTH 3 is not waterproof. Prevent contacts of any kind of liquid or cleaner with SMOOTH 3. It is recommended to use dry cloth for cleaning.
  - 4)Protect SMOOTH 3 from dust and sand during use.
- **NOTICE:**

Keep the handle stable when SMOOTH 3 is powered on, as shaking may cause failure to start up.

This document is subject to change.  
ZHIYUN™ is a trademark of ZHIYUN TECH.  
Copyright©2017 ZHIYUN TECH. All rights reserved.

### Disclaimer

This Battery Safety Guidelines and all relevant documents are subject to change at the sole discretion of ZHIYUN TECH. ZHIYUN TECH reserves the right to make changes at any time without notice. For updated product information, please visit ZHIYUN's official website.

### Glossary

- **WARNING:** Procedures, which if not properly followed, may incur property damage, grave accident, or serious injury.
- **CAUTION:** Procedures, which if not properly followed, may incur property damage and serious injury.

### WARNINGS

Read the ENTIRE User Guide to become familiar with the features of this product before operating. Failure to operate the product correctly can result in damage to the product or personal property and cause serious injury. This is a sophisticated product. It must be operated with caution and common sense and requires some basic mechanical ability. Failure to operate this product in a safe and responsible manner could result in injury or damage to the product or other property. This product is not intended for use by children without direct adult supervision. DO NOT use with incompatible components or in any way otherwise as mentioned or instructed in the product documents provided by ZHIYUN. The safety guidelines herein contain instructions for safety, operation and maintenance. It is essential to read and follow all of the instructions and warnings in the User Guide, prior to assembly, setup or use, in order to operate the product correctly and avoid damage or serious injury.

- **WARNING**

To avoid fire, serious injury, and property damage, observe the following safety guidelines when using, charging, or storing your batteries.

**Battery Use**

1. Prevent the batteries to come into contact with any kind of liquid. Do not leave batteries out in the rain or near a source of moisture. Do not drop the battery into water. If the inside of the battery comes into contact with water, chemical decomposition may occur, potentially resulting in the battery catching on fire, and may even lead to an explosion.
2. If the battery falls into water with the stabilizer during use, take it out immediately and put it in a safe and open area. Maintain a safe distance from the battery until it is completely dry. Never use the battery again, and dispose of the battery properly as described in the Battery Disposal section below.
3. If the battery catches fire, use water, water spray, sand, fire blanket, dry powder, or carbon dioxide fire extinguisher immediately to put out the fire. Please extinct the fire by applying the methods recommended above according to the actual situation.
4. Never use non-ZHIYUN batteries. If replacement or backup is needed, please purchase new batteries from ZHIYUN's official website or authorized channels. ZHIYUN takes no responsibility for any damage caused by non-ZHIYUN batteries.
5. Never use or charge swollen, leaky, or damaged batteries. Never use or charge if the battery smells, or overheats (exceeding maximum temperature of 160°F / 71°C). If your batteries are abnormal, contact ZHIYUN or a ZHIYUN authorized dealer for further assistance.
6. The battery should be used within the temperature range from -10°C to 45°C. Use the battery in environments above 45°C can lead to a fire or explosion. Use of battery below -10°C can lead to serious battery damage.
7. Do not use the battery in strong electrostatic or electromagnetic environments. Otherwise, the battery protection board may malfunction.
8. Do not disassemble or use any sharp object to puncture the battery in any way. Otherwise, the battery may leak, catch fire or explode.
9. Do not mechanically strike, crush, or throw the battery. Do not place heavy objects on the battery or charger.
10. Electrolytes inside the battery are highly corrosive. In case of accidental contact of any electrolytes with your skin or eyes, rinse immediately with water for at least 15 minutes and seek medical advice as soon as possible.
11. Do not use the battery if it has been involved in a crash or heavy impact.
12. Do not heat the battery and never put the battery in a microwave oven or in a pressurized container.
13. Do not place the battery cell on a conductive surface (such as a metal desk surface).

14. Prevent use of wires or other metal objects that could cause positive and negative short-circuit to the battery.
15. If the battery terminal is dirty, wipe it with a clean, dry cloth. Otherwise it will cause a bad battery connection, which may result in energy loss or charging failure.

**Battery Charging**

1. Do not attach the batteries to a wall outlet or car charger socket directly. Always use a ZHIYUN approved adapter for charging. ZHIYUN takes no responsibility if the battery is charged using a non-ZHIYUN charger.
2. Do not put the battery and charger near flammable materials or on flammable surfaces (such as carpet or wood). Never leave the battery unattended during charging to prevent any accident.
3. Do not charge the battery immediately after use, because the battery temperature may be too high. Do not charge the battery until it cools down to normal room temperature. Charging the battery with its temperature over 45°C or lower than 0°C may lead to leakage, overheating, or damage.
4. Examine the charger before use, make sure there is no damage to the enclosure, cord, plug, or other parts. Never use a damaged charger. Do not clean the charger with any liquid containing alcohol or other flammable solvents. Disconnect the charger when not in use.

**Battery Storage**

1. Keep batteries out of the reach of children and pets.
2. Do not leave the battery near heat sources such as a furnace or heater, or inside of a vehicle on hot days. Never expose the battery in any environment with temperature of over 60°C. The ideal storage temperature is 22°C-28°C.
3. Store batteries in a dry environment.
4. Do not leave the battery unused for too long after it has been completely discharged to prevent over-discharge of battery which may result in battery damage and permanent failure.

**Battery Maintenance**

1. Never use the battery when the temperature is too high or too low.
2. Do not store the battery in any environment with a temperature of over 60°C.

**Battery Maintenance**

1. Never use the battery when the temperature is too high or too low.
2. Do not store the battery in any environment with a temperature of over 60°C.

**Transportation Notice**

1. Discharge the battery power to 25% or lower before carrying the battery on an airline flight. Only discharge the battery in a fireproof location, ideally in a dry and open area.
2. Do not store or transport batteries together with metal objects such as eyeglasses, watch, and jewelries, etc.
3. Do not transport damaged batteries. When transporting, be sure to discharge the battery to less than 50%.

**Battery Disposal**

Dispose of the battery in specific recycling boxes only after a complete discharge. Do not put away the battery in regular trash containers. Strictly follow your local regulations regarding the disposal and recycling of batteries.

**Battery Use**

Make sure the batteries are fully charged before each time of use.

**Battery Charging**

The battery will stop charging automatically when it is full. Disconnect the batteries from the charger when fully charged.

**Battery Storage**

1. Discharge the battery to 40%-65% if it will NOT be used for over 10 days. This can greatly extend the battery life.
2. The battery enters hibernation mode when voltage gets too low. Charge the battery will bring it out of hibernation.
3. Remove batteries from the stabilizer when not in use and store them in a specialized container.

**Battery Maintenance**

1. Never over-discharge, as this may lead to battery cell damage.
2. Battery performance may be affected if not used for a long time.
3. Charge and discharge the battery once every 3 months to keep it active.

**Battery Disposal**

If the battery cannot be fully discharged, do not leave it in the recycling box, but contact a professional battery disposal/recycling agent for further assistance.

Get to Know SMOOTH 3

Check the product package before use, make sure that all items below have arrived with the product. In case that any item is found missing, please contact ZHIYUN or your local selling agent.

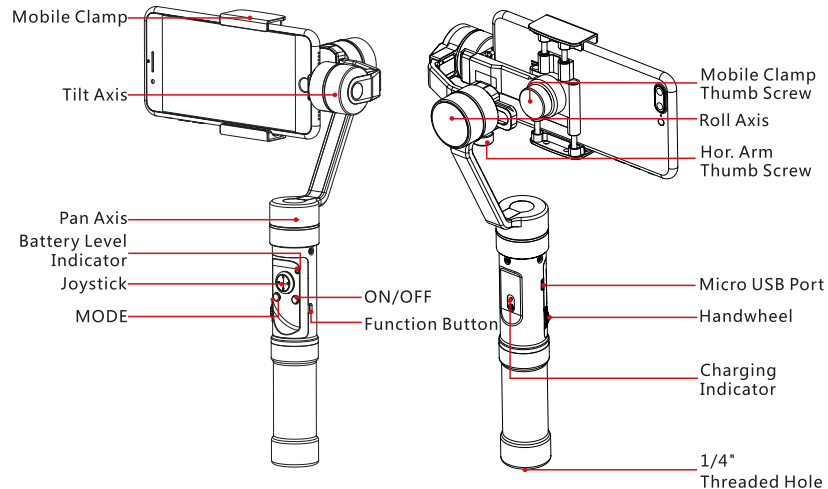

The Micro USB cable can be used for direct charging of SMOOTH 3 without need to take out the battery. In addition, it can also be used for firmware upgrade and calibration by connecting the stabilizer to a computer.

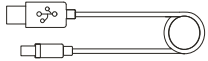

#### Micro USB Cable

26650 Li-ion Battery  
Capacity : 4600mAh  
Voltage : 3.7V

#### NOTICE

1. This charging method is for charging ZHIYUN's IMR 26650 Li-ion Battery only. Do not charge batteries of other models or brands, otherwise it may lead to accident.

2. Use qualified 5V adapter with output current of  $\geq 1000\text{mA}$  only. Charging time depends on the max. output current of the adapter.

Please use and charge batteries provided or approved by ZHIYUN only. ZHIYUN will not take any responsibility for explosion, fire and/or accidents caused by non-ZHIYUN batteries.



By using a dedicated mobile charging cable provided by ZHIYUN, users can charge their smartphone directly through the power output port on tilt axis of the SMOOTH 3 stabilizer.  
(The mobile charging cable shall be purchased separately.)

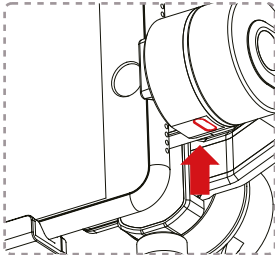

## Reading Tips

Legends: Hints and tips Important

## APP Download and Installation



Download the APP from the "Downloads" page on ZHIYUN's official website [www.ZHIYUN-TECH.com](http://www.ZHIYUN-TECH.com), or by directly scanning the QR code on the left (Android 5.0 above or iOS9.0 above required) to download. Users can download the APP by searching "ZY Play" in Google Play or APP Store.

The ZHIYUN APP is subject to regular update, try out now to discover more functions.



## Smartphone Installation

Push and hold open the camera clamp, slide the smartphone in as close as possible against the tilt axis motor, and clamp on.

**⚠ Do not power on the stabilizer before the smartphone is properly mounted.**

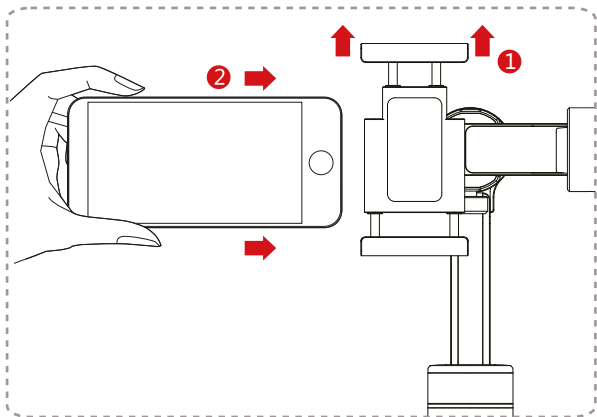

## Gravity Center Adjustment

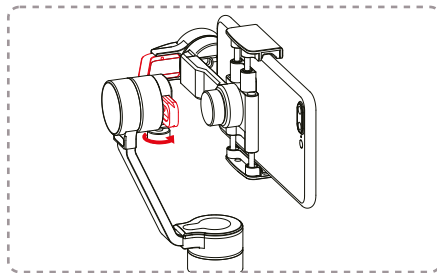

1. Proper adjustment of gravity center ensures better power saving during operation.
2. Loosen the Hor. Arm Thumb Screw to adjust the gravity center by sliding the horizontal arm (as marked red in the Figure) until the smartphone stays still and vertical on the tilt axis.
3. Tighten the Thumb Screw after the smartphone is well balanced in level to ensure normal operations.

**⚠ The scale mark on the horizontal arm allows easier balancing adjustment as the user can memorize the specific balancing position for mounting of most used devices.**

## Switching Mobile Mounting Direction

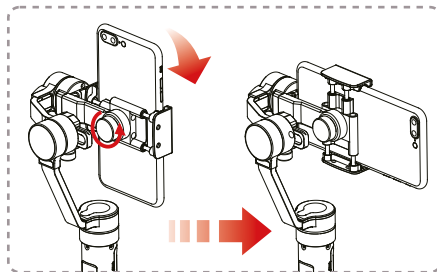

- Loosen the Mobile Clamp Thumb Screw on the back and rotate the mobile clamp to the desired direction (either in horizontal or vertical). Tighten the Thumb Screw to ensure normal operations.

**⚠ Make sure the stabilizer is powered off before changing the mobile mounting direction.**

## Control Panel Introduction

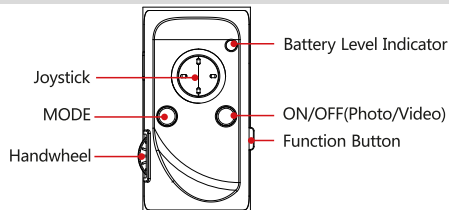

### Battery Level Indicator

- Quick flashing blue light (the flashing frequency indicates different battery level):
  - Quick flash 4 times for battery level of 76%-100%.
  - Quick flash 3 times for battery level of 51%-75%.
  - Quick flash 2 times for battery level of 26%-50%.
  - Quick flash 1 time for battery level of 1%-25%.
  - Solid blue light: Indicates current active control mode as Locking Mode.
- Shines yellow light when the stabilizer is powered ON/OFF:
  - 1.Quick flash for 3 sec. and shines solid for 1 sec. when powered on.
  - 2.Quick flash for 3 sec. when powered off.
  - 3.Quick flashing during firmware upgrade.
- Solid red light: Indicates malfunction with the gimbal.

### Power/Shutter

Power on/off the stabilizer by pressing the Power button for about 3 sec.  
The Power button is used for camera shooting controls when paired to the Mobile APP.  
Single press to take a photo, or double press to record a video, and double press again to stop recording.

### Handwheel

When connected to a smartphone with the ZY Play APP on, turn up or down the Handwheel can adjust settings of focal length, ISO, white balance, shutter speed or exposure compensation, whichever is selected in the APP or through the Function Button.

### Function Button

When connected to a smartphone with the ZY Play APP on, by activating the Manual Mode in the camera setting panel, single press the Function Button can switch between settings items including focal length, ISO, white balance, shutter speed and exposure compensation.

### Joystick Operation

Joystick controls the camera movement when pushed or pulled up/down and left/right.

## How to Power ON/OFF

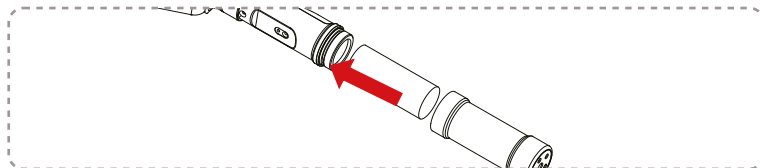

Rotate to loosen the end cover, then install a 26650 Li-ion battery (with the positive pole heading the arrow direction as shown above). Make sure to tighten the end cover properly after battery installation, or the stabilizer cannot be turned on.

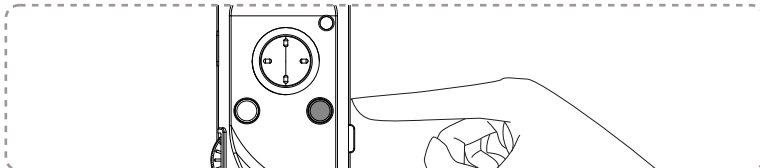

After the batteries are installed properly, long press the power button for 3 sec. to power on.

- ⚠ Please use batteries provided or approved by ZHIYUN only, otherwise it may cause accidents. When using the stabilizer for the first time, please hold the camera with one hand to prevent severe shaking of the camera in case a malfunction occurs to the stabilizer (in very rare cases).

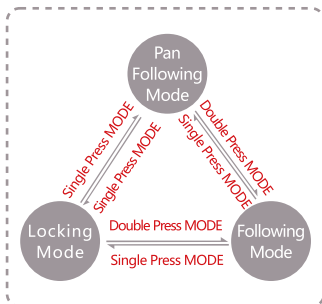

**Mode switch:**The stabilizer enters Pan Following Mode by default each time when powered on. Switch into Locking Mode by single pressing on the Mode button. Double press the Mode button to enter the Following mode. Single press the Mode button under the Following Mode will return to the previous mode.

See ZHIYUN's product training videos on [www.ZHIYUN-TECH.com](http://www.ZHIYUN-TECH.com) for more operation tips.

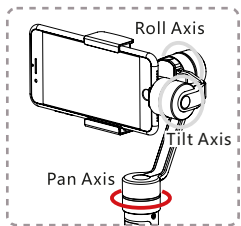

**Pan Following Mode:** The camera pans left/right following the movement of the stabilizer while the tilt and roll axes are locked. Push the joystick up/down allows manual control of the tilt axis.

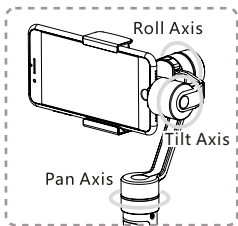

**Locking Mode:** This mode locks movement of all three axes to keep the camera still and stable. Push the joystick up/down and left/right allows manual control of the tilt axis and pan axis.

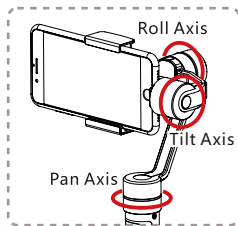

**Following Mode:** The camera pans and tilts following the movement of the stabilizer. Push the joystick left/right allows manual control of the roll axis.

Quick press MODE (Joystick) three times and the camera will turn 180° along the pan axis while the active control mode remains unchanged.

### Firmware Upgrade thru PC

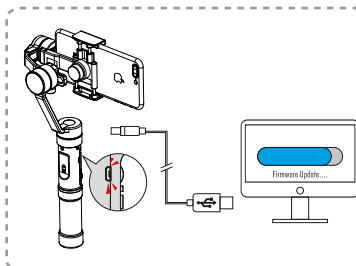

Connect the stabilizer to your computer using the Micro USB cable for firmware upgrade and on-line calibration. Calibration can also be operated through mobile APP.

1. Visit ZHIYUN's official website: [www.ZHIYUN-TECH.com](http://www.ZHIYUN-TECH.com).
2. Click to open the "Downloads" page, and find the latest Firmware Upgrade package corresponding to your stabilizer model to download. (USB driver not required in case you are using iOS or WIN 10 system.)
3. Power on the stabilizer and long press MODE Button to enter standby mode. Connect the stabilizer to your PC with a USB cable.
4. Click to open "My Computer" and then launch the "USB Disk" to find and open the "Firmware.ptz" file. Copy paste the newest firmware file to replace the old one.
5. When the Battery Level Indicator of the stabilizer shines RED & BLUE for about 3 sec., then upgrade is successful.

**⚠ Make sure the battery has been properly installed during firmware upgrade. If upgrade fails, the indicator will shine solid RED light. In this case, please find and open the "log.txt" file from the "USB Disk" and make a screen shot of the text content and send it to ZHIYUN's customer service.**

### Connecting the Stabilizer to Smartphone

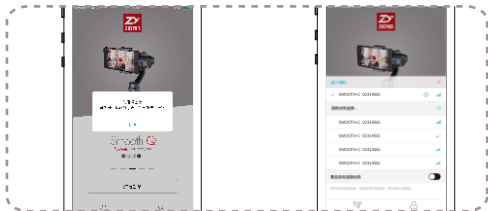

1. Power on the stabilizer.
2. Turn on Bluetooth in Settings of your smartphone.
3. Tap the ZY Play APP icon to open. Tap the signal icon on the top of the APP screen to search for nearby signals, choose your stabilizer to connect.

### How to Take Photos & Videos





#### Photo/Video Switch thru the Stabilizer

- Single press the Power/Shutter button to take a photo.  
Double press the Power/Shutter button to start/stop video recording.

#### Photo/Video Control and Settings thru APP

1. Tap the Photo/Video icon on the left of ZY Play operation screen to switch between "PHOTO" and "VIDEO" shooting.

- a. When in photo shooting mode, tapping  on the right side of the screen will open a menu, on which you can select a shooting mode: single shot, panorama, and long exposure.
  - b. When in video shooting mode, tapping  allows you to select a recording mode: default, slow motion, time lapse and moving time lapse.
2. Tap  on the left of ZY Play operation screen to switch between the rear and front cameras.

 Long press the Function Button can also make front/rear camera switch.

### How to Adjust Stabilizer Parameters



- Tap the Gear icon onscreen to open the "Settings" menu, and select PTZ. Tap to select a specific item and then adjust the parameter by rolling up/down. Tap Save to finish adjustment.

### How to Activate Handwheel Manual Control Mode

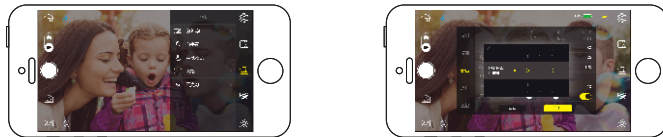

1. Tap  on the right of the operation screen, select to activate Manual control mode.
2. Under Manual control mode, single press the Function button on the stabilizer handle can switch between settings options including focal length, ISO, white balance, shutter speed and exposure compensation.
3. In each of these settings options, you can make precise adjustment by rolling the Handwheel up/down.

### How to Upgrade Gimbal Firmware

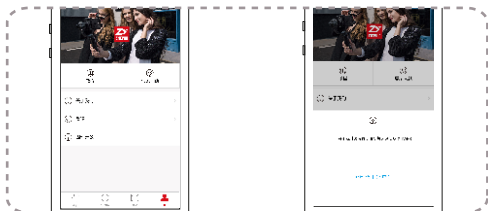

1. Tap "Me" on the Home screen of ZY Play, and then select "Firmware Upgrade".
2. Tap to Download the latest firmware. Do not exit the ZY Play or power off the device during firmware download.

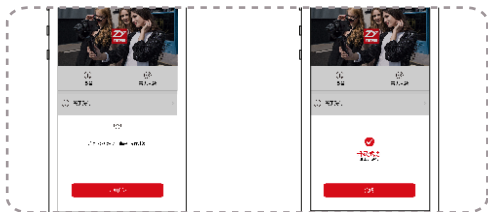

3. When download complete, tap to Upgrade the firmware.
4. Wait for the firmware upgrade to complete, do not exit the ZY Play or power off the device during firmware upgrade.
5. A prompt will pop up showing "Upgrade successful." when upgrade complete.

### What to Do When Upgrade Failed

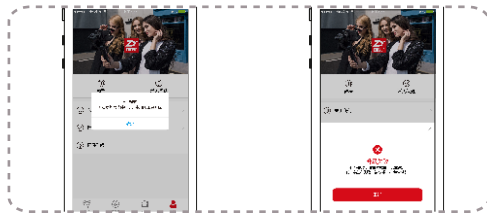



1. During maintenance period, "Firmware Upgrade" may not function in ZY Play. In this case, please connect your device to a PC instead for firmware grade.
2. If "Firmware upgrade failed." thru ZY Play, please try again by re-launching the APP. If upgrade still fails, contact ZHIYUN customer service.

💡 The ZHIYUN APP is subject to regular update, try out now to discover more functions.

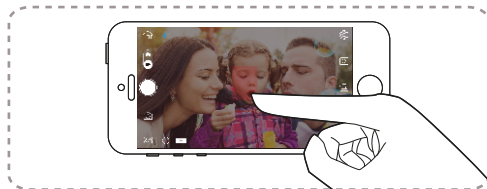
### How to Use Object Tracking



1. Tap  on the bottom left of the operation screen to activate Object Tracking function (the stabilizer enters Locking Mode automatically when this function is activated).
2. After the function is activated, drag to draw a box onscreen around the target object will enable auto tracking.
3. Tap Exit beside  to stop Object Tracking.

- NOTICE: All accessories hereunder shall be purchased separately.

## Dual-hand Handles

- NOTE:  
The Dual Handles are compatible with: CRANE, CRANE-M, CRANE-S and SMOOTH 3.

Top Down Gesture

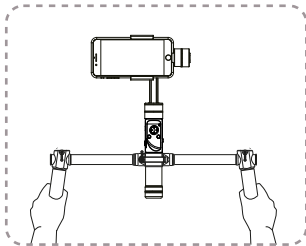

Bottom Up Gesture

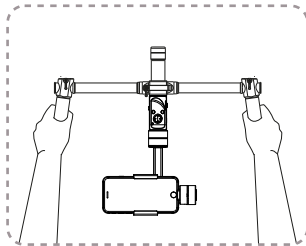

## Mounting Method

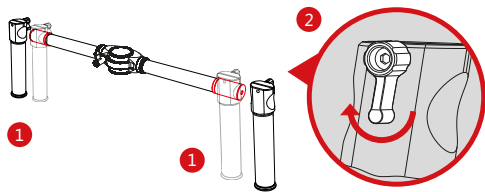

NOTICE: Install the handles to the Red Area as marked above.

## Mounting Method

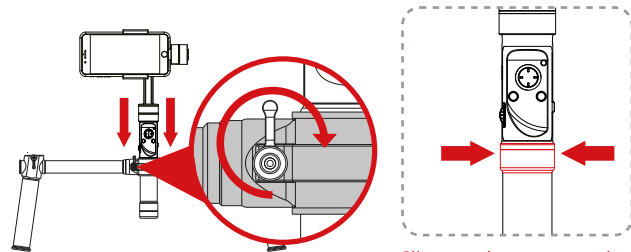

Clip onto the area as marked Red above.

## ZW-B02 Wireless Remote Control

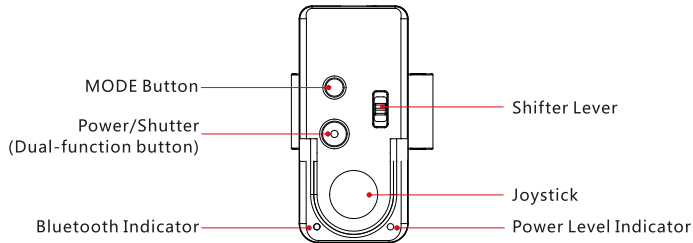
**Power/Shutter (Dual-function button):**

Power on/off:

Power on/off the remote controller by pressing the Power button for 1 to 2 sec.

The indicator light will turn on/off accordingly.

NOTICE: Shutter control is not available when used with SMOOTH 3.

**Combined Button Controls**

**Power Button + Shifter Lever:** Push the Shifter Lever in W direction simultaneously when powering up to enter Slave Mode. This allows firmware upgrade of the remote controller through mobile APP (requires Bluetooth pairing with the smartphone using ZY Play).

**Power Button + MODE Button:** Press the MODE Button simultaneously when powering up to operate quick pairing with the nearest stabilizer.

**CMODE Button:** Switches between gimbal control modes (works like the MODE button on the stabilizer).

**Joystick:** Controls camera movement (functions the same as the Joystick on SMOOTH 3).

**Shifter Lever:** Allows zooming control of the camera.

**Specifications:**

Charging voltage: 5V

Charging current: 100mA

Theoretical work time:  $\geq 30$  hr.

Built-in Polymer lithium battery capacity: 150mAh

Emission and received current: 11.9mA

Operating current: 4.2mA

Effective control distance: 10M (without blockage)

**Power Level Indicator**

90%-100%: quick flash for 4 times each second.

75%-90%: quick flash for 3 times each second.

55%-75%: quick flash for 2 times each second.

30%-55%: quick flash for 1 time each second.

0%-30%: quick flashing.

**Bluetooth Indicator**

No connection: Continuous flashing.

Connected: Shines solid light.

**Charging Indicator**

Charging: RED light.

Charging complete: GREEN light.

## Mounting Method

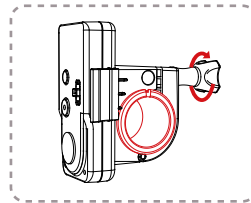

1. Loosen the thumb screw on the back of the remote controller to let loose of the rubber case (as marked red in the Figure).

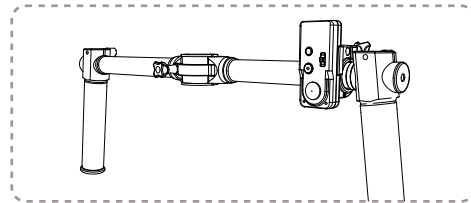

2. Install the remote controller to the extension rod or dual handle for convenient operations (as shown in the Figure above). Fasten up by tightening the thumb screw on the back.

The remote controller turns off automatically when left idle for 2 minutes.

### Initializing the Stabilizer

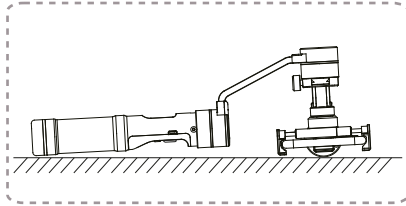

#### Initialize the stabilizer under the following circumstances:

1. Slight deviation is found in the tilt angle of the camera in level position after startup.
2. Slight deviation is found in the roll angle of the camera in level position after startup.
3. Frequent small angle correction is found when the camera is in level position while the stabilizer stays still.

#### Initialization Procedure

1. Install the batteries and smartphone properly.
2. Power on the stabilizer.
3. Press the Joystick for 3 sec. to enter standby mode.
4. Put the stabilizer still on a table surface in random pose, wait for about 10 sec., and the stabilizer will automatically complete initialization.

### On-line Calibration

#### Calibrate the stabilizer when any of the following circumstances occurs:

1. Deviation is found in the balancing of the smartphone even after initialization.
2. The stabilizer has not been used for a long time.
3. The stabilizer is exposed to significant temperature change.

#### Calibration Method

1. Visit ZHIYUN's official website: [www.ZHIYUN-TECH.com](http://www.ZHIYUN-TECH.com).
2. Click to open the "Downloads" page, and find ZHIYUN' s Gimbal Tools as well as online calibration tutorial; OR
3. Operate calibration on the ZY Play APP by connecting to the smartphone.

	Min.	Standard	Max.	Remarks
Input Vol.	3.6V		4.3V	
Operation Current	80mA	110mA	600mA	
Operation Temperature	-10°C		45°C	
Operation Time		12h		Well balanced with camera mounted
Weight		440g		
Tilt Angle Range		320°		
Roll Angle Range		320°		
Pan Angle Range		360°		Unlimited rotation
Compatible Models	Smartphones with sizes under 6.0"; GoPro 3/4/5			
Controllable Tilt Angle	-135°		+185°	
Controllable Roll Angle	-30°		+30°	
Controllable Pan Angle		360°		Unlimited rotation
Payload	75g		260g	
Charging Time		2.5h		
Charging Voltage		5V		
Charging Current		2000mA		
Power Output Vol.		5V		
Power Output Current		1000mA		



### Warranty Period

1. Customers are entitled to replacement or free repair service in case of quality defect(s) found in the product within 15 days upon receipt of the product.
2. Customers are entitled to free repair service from ZHIYUN for any product proven defective in material or workmanship that results in product failure during normal consumer usage and conditions within the valid warranty period, which is 12 months counting from the date of delivery.

### This warranty does not apply to the followings

1. Products subjected to unauthorized repair, misuse, collision, neglect, mishandling, soaking, accident, and unauthorized alteration.
2. Products subjected to improper use or whose labels or security tags have been torn off or altered.
3. Products whose warranty has expired.
4. Products damaged due to force majeure, such as fire, flood, lightning, etc.

### Warranty Claim Procedure

1. If failure or any problem occurs to your product after purchase, please contact a local agent for assistance, or you can always contact ZHIYUN's customer service through email at SERVICE@ZHIYUN-TECH.COM or website at WWW.ZHIYUN-TECH.COM.
2. Your local agent or ZHIYUN's customer service will guide you through the whole service procedure regarding any product issue or problem you have encountered.
3. ZHIYUN reserves the right to reexamine damaged or returned products.

### Custom information

Customer Name :

Contact No :

Address :

### Sales Information

Sales Date :

Prod. Serial No :

Dealer :

Contact No :

### #1 Maintenance Record

Service Date :

Signature of Repairman :

Cause of Problem :

Service Result :

 Solved Unsolved Refunded(Replaced)



Website



Weibo



Vimeo



Google+



Facebook



Wechat



Youku



Youtube

Tel: +86-773-2320856

Web: [www.zhiyun-tech.com](http://www.zhiyun-tech.com)

E-mail: [service@zhiyun-tech.com](mailto:service@zhiyun-tech.com)

Address: Creative Industrial Park, GuiMo Road, QiXing District, Guilin  
541004, Guangxi, China.

## Certificate of Quality

This product is confirmed to meet quality standards and permitted for sale after strict inspection.

QC Inspector: \_\_\_\_\_

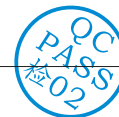

Please download the latest version from [www.zhiyun-tech.com](http://www.zhiyun-tech.com)

This document is subject to change.

ZHIYUN™ is a trademark of ZHIYUN.

Copyright©2017 ZHIYUN. All rights reserved.